



## Obstetrics/Gynecology

Scissors .....	638-648
Needle Holders .....	649-650
Forceps .....	651-682
Clamps .....	683-689
Retractors .....	690-693
Vaginal Specula .....	695-713
Dilators & Probes .....	714-718
Curettes .....	719-725
Accessories .....	726

# Obstetrics/Gynecology

## Scissors

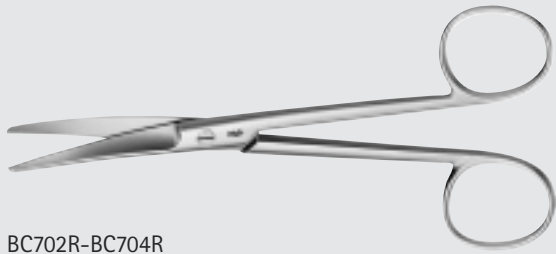

BC702R-BC704R

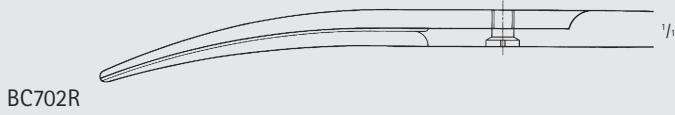

BC702R



BC703R

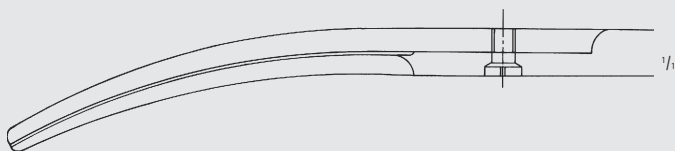

BC704R

### WERTHEIM Scissors

Catalog Number	Tip	Blade	Length (in.)
BC702R	B/B	CVD	5 3/4
BC703R	B/B	CVD	8
BC704R	B/B	CVD	9



BC708R

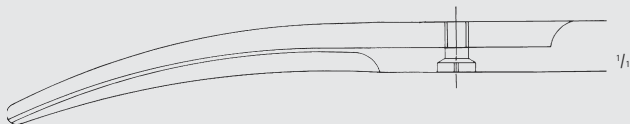

### SIMS Scissors

Catalog Number	Tip	Blade	Length (in.)
BC708R	B/B	CVD	8 1/4

OB/GYN

MILLIMETERS

SIMS Scissors  
(continued)

Catalog Number	Tip	Blade	Length (in.)
BC721R	B/B	STR	8
BC723R	B/B	STR	9
BC741R	B/B	CVD	8
BC743R	B/B	CVD	9

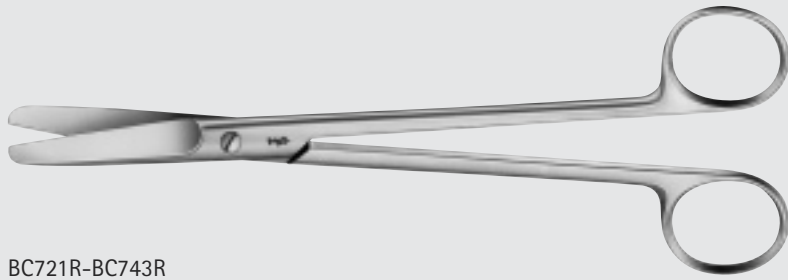

BC721R-BC743R

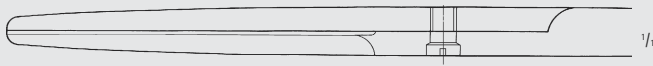

BC721R

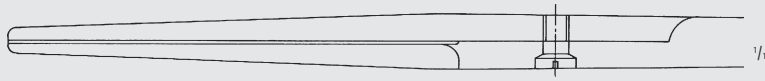

BC723R

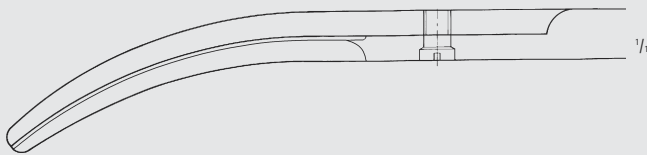

BC741R

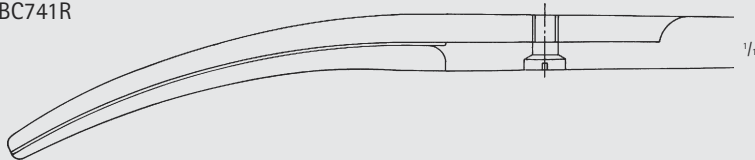

BC743R



INCHES

# Obstetrics/Gynecology

## Scissors



BC746R-BC748R

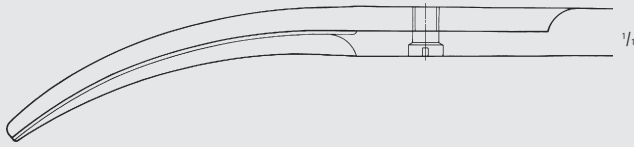

BC746R

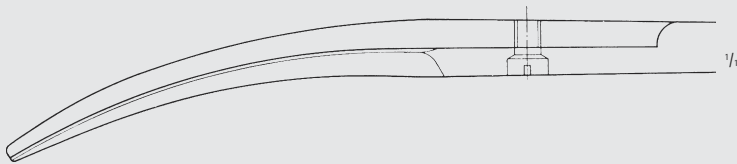

BC748R

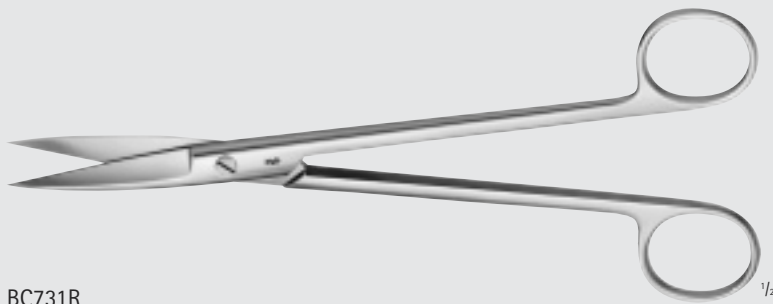

BC731R

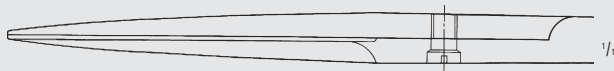

### SIMS Scissors

Catalog Number	Tip	Blade	Length (in.)
BC746R	S/B	CVD	8
BC748R	S/B	CVD	9
BC731R	S/S	STR	8

OB/GYN

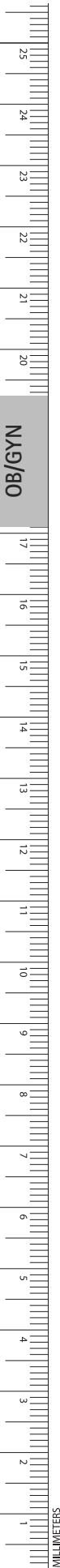



JORGENSEN Scissors

Catalog Number	Tip	Blade	Length (in.)
MD491	B/B	CVD	9

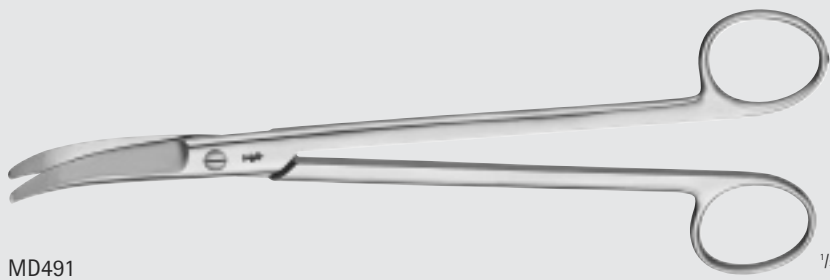

MD491

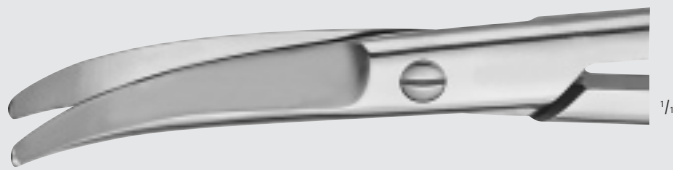

SIEBOLD Uterine Scissors

Catalog Number	Tip	Blade	Length (in.)
BC760R	B/B	CVD	9 3/4

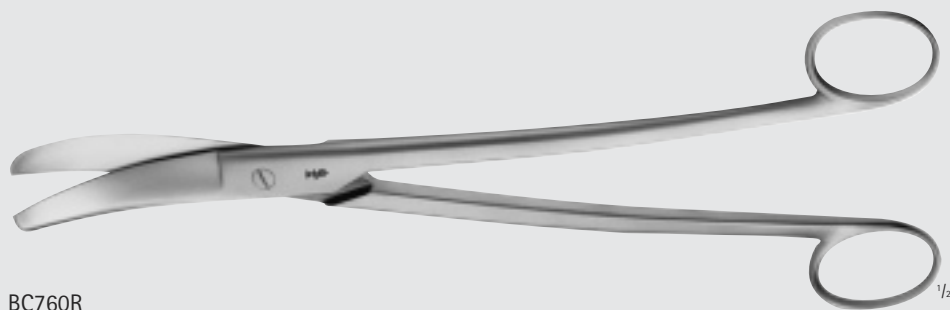

BC760R



# Obstetrics/Gynecology

## Scissors

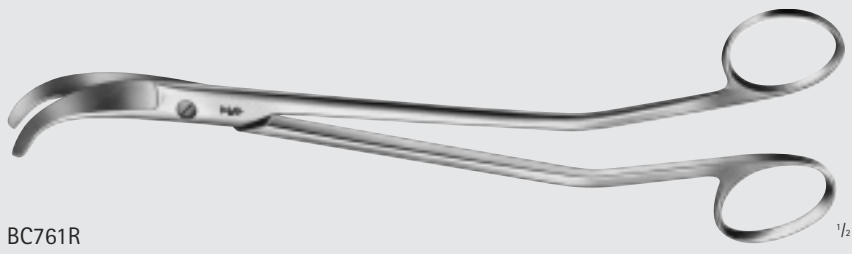

BC761R

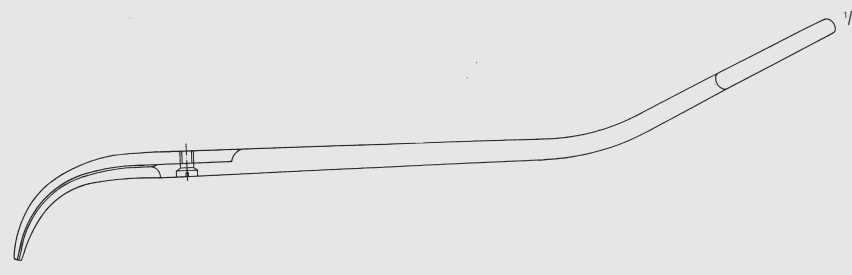

### BOZEMANN Uterine Scissors

Catalog Number	Tip	Blade	Length (in.)
BC761R	B/B	CVD	8 3/4

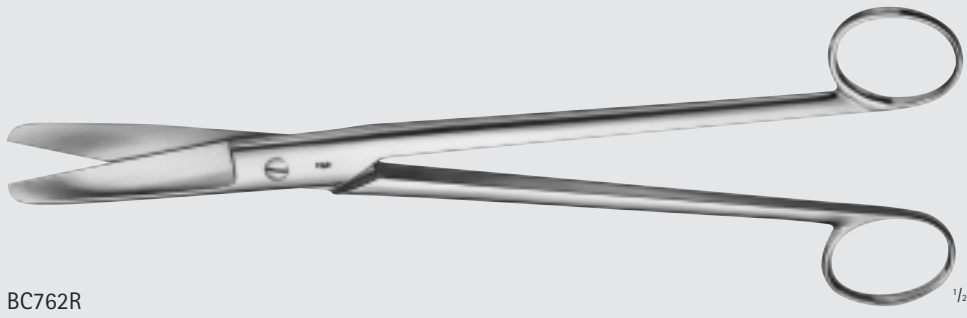

BC762R

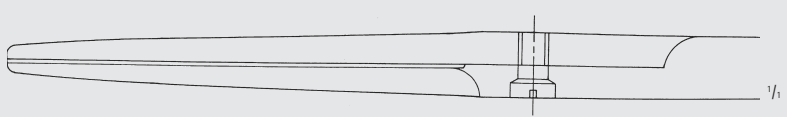

### SIMS-SIEBOLD Uterine Scissors

Catalog Number	Tip	Blade	Length (in.)
BC762R	B/B	STR	10

DUROTIP TC MAYO Dissecting Scissors

Catalog Number	Tip	Blade	Length (in.)
BC558R	B/B	STR	9
BC559R	B/B	CVD	9



BC558R-BC559R

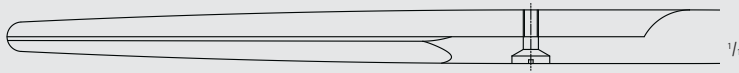

BC558R



BC559R



INCHES

# Obstetrics/Gynecology

## DUROTIP® TC Scissors

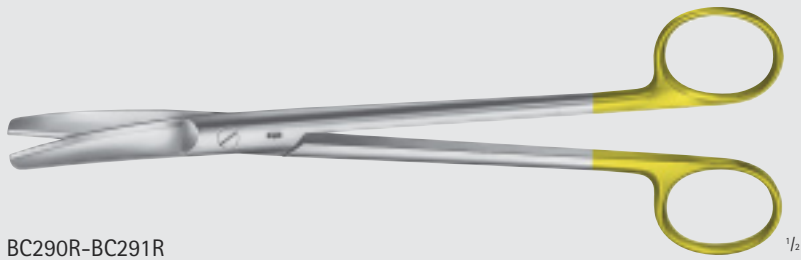

BC290R-BC291R

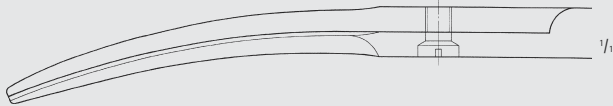

BC290R

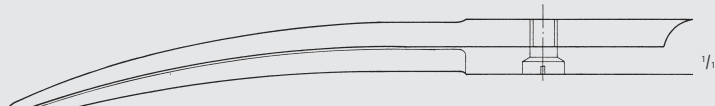

BC291R

### DUROTIP TC SIMS Uterine Scissors

Catalog Number	Tip	Blade	Length (in.)
BC290R	B/B	CVD	8
BC291R	B/B	CVD	9

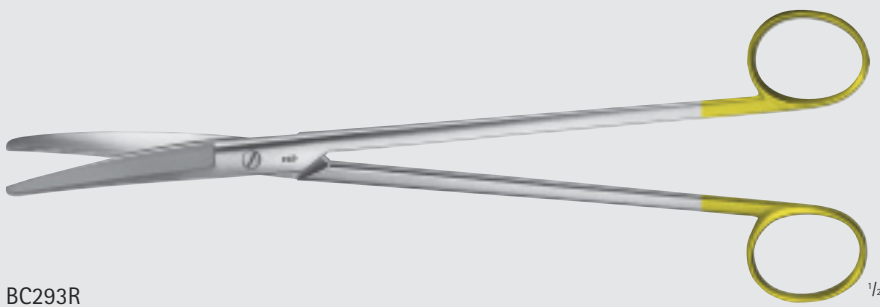

BC293R



### DUROTIP TC WERTHEIM Scissors

Catalog Number	Length (in.)
BC293R	9



DUROTIP TC Hysterectomy Scissors,  
For Use With BJ551R, BJ552R Clamps

Catalog Number	Tip	Blade	Length (in.)
BC551R	B/B	CVD	10
BC552R	B/B	CVD	10
BJ551R			9 3/4
BJ552R			9 1/2



BC551R-BJ552R



BC551R

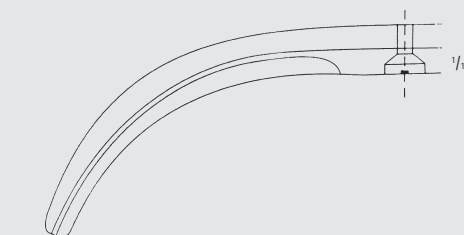

BC552R

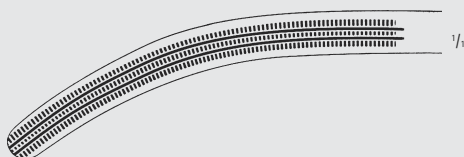

BJ551R

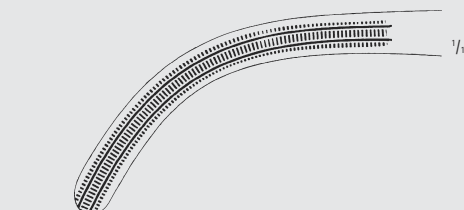

BJ552R

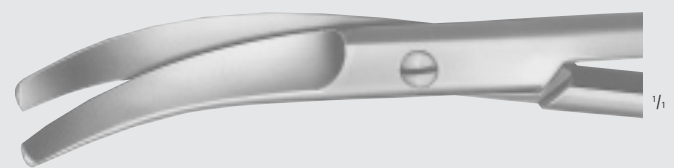

OB/GYN

INCHES

# Obstetrics/Gynecology

## DUROTIP® TC Scissors



### Wavecut

Wavecut scissors have one serrated cutting edge to prevent tissue from slipping. The W after the item number indicates the scissors are the wavecut style, e.g. BC211W.



BC290W-BC291W

### DUROTIP TC SIMS Uterine Wavecut Scissors

Catalog Number	Tip	Blade	Length (in.)
BC290W	B/B	CVD	8
BC291W	B/B	CVD	9

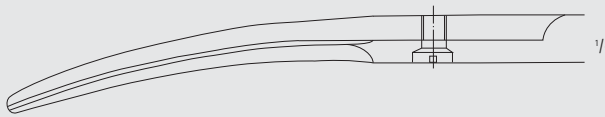

BC290W



BC291W

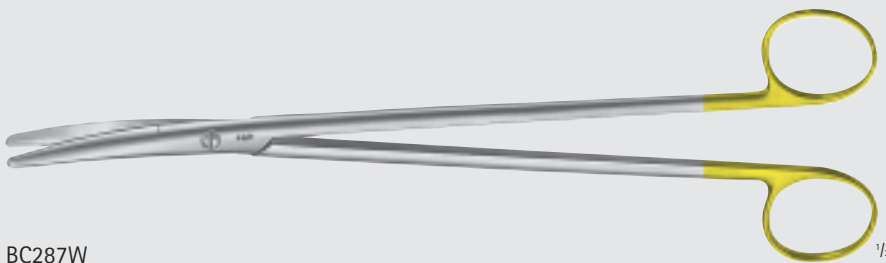

BC287W

### DUROTIP TC METZENBAUM Wavecut Dissecting Scissors, Heavy

Catalog Number	Tip	Blade	Length (in.)
BC287W	B/B	CVD	9

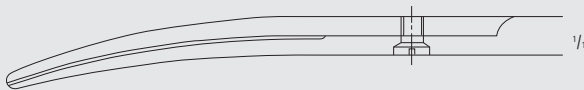

OB/GYN

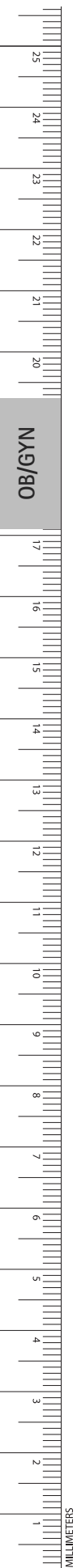

Umbilical Cord Scissors

Catalog Number	Tip	Blade	Length (in.)
BC796R	B/B	LAT-CVD	5 1/4
BC797R	B/B	LAT-CVD	6 1/4



BC796R-BC797R



BC796R

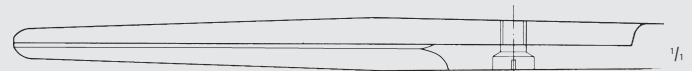

BC797R

Umbilical Cord Scissors

Catalog Number	Length (in.)
ET152R	4 1/8



ET152R

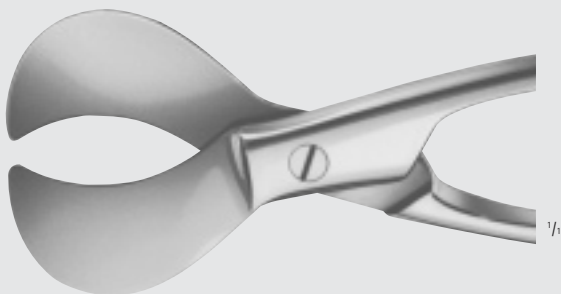

OB/GYN

INCHES

# Obstetrics/Gynecology

## Scissors

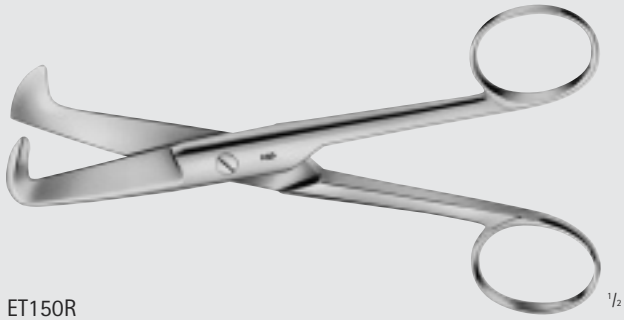

ET150R

1/2

### SCHUHMACHER Umbilical Cord Scissors

Catalog Number	Length (in.)
ET150R	6

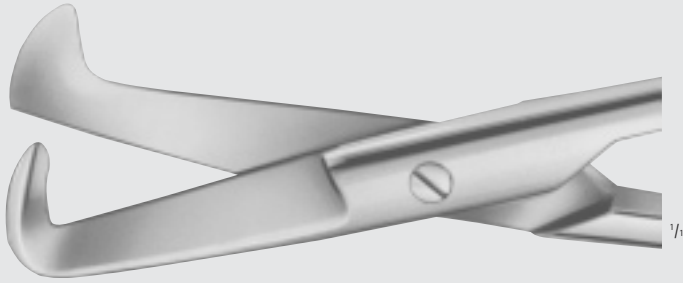

1/1



ET140R-ET141R

1/2

### BRAUN-STADLER Episiotomy Scissors

Catalog Number	Blade	Length (in.)
ET140R	SERR	5 3/4
ET141R	SERR	8

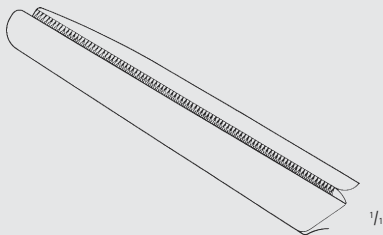

ET140R

1/1

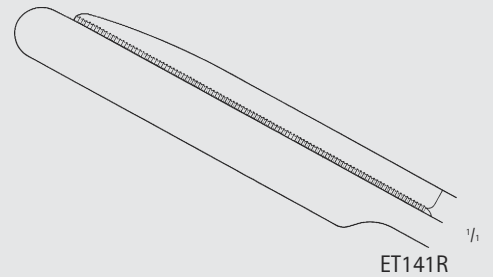

ET141R

1/1

OB/GYN



HEANEY Needle Holder

Catalog Number	Tip	Jaw	Length (in.)
BM259R	CVD	SERR	8

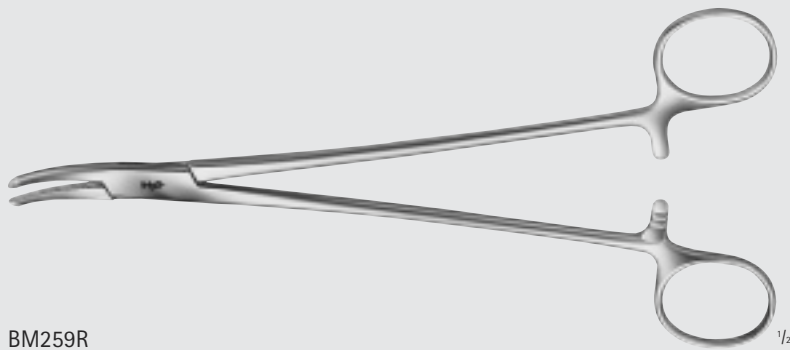

BM259R

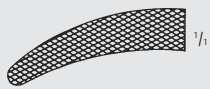

Aesculap features Needle Holders with Tungsten Carbide (TC) inserts. A smooth jaw and three different serration patterns are available, depending on the size of the suture needle.

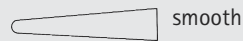
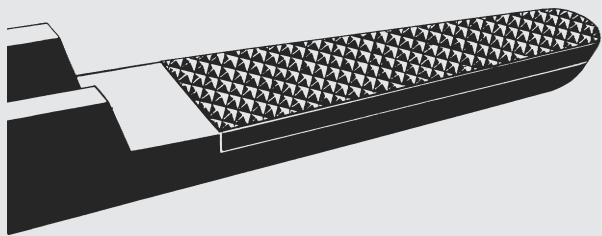

smooth



0.2



0.4



0.5

We recommend carbide inserts

with smooth jaw surface for suture material

9/0 - 11/0

with 0.2 mm pitch of serration for suture material

6/0 - 10/0

0.4 mm

4/0 - 6/0

0.5 mm

up to 3/0

DUROGRIP TC HEANEY Needle Holder

Catalog Number	Tip	Jaw	Length (in.)
BM081R	CVD	SERR	8
BM084R	CVD	SERR	10 1/4

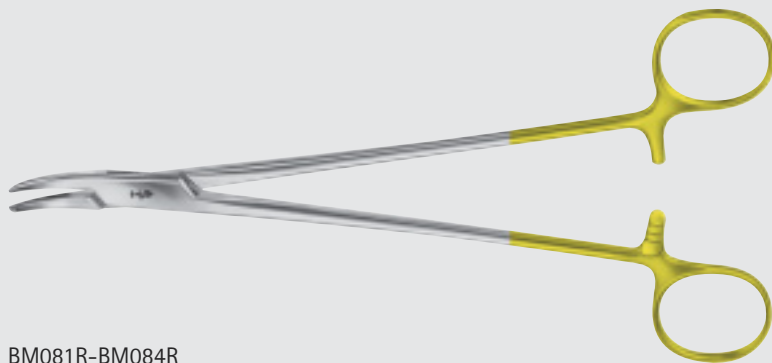

BM081R-BM084R

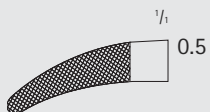

BM081R

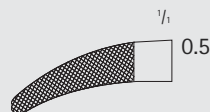

BM084R



INCHES

# Obstetrics/Gynecology

## Needle Holders

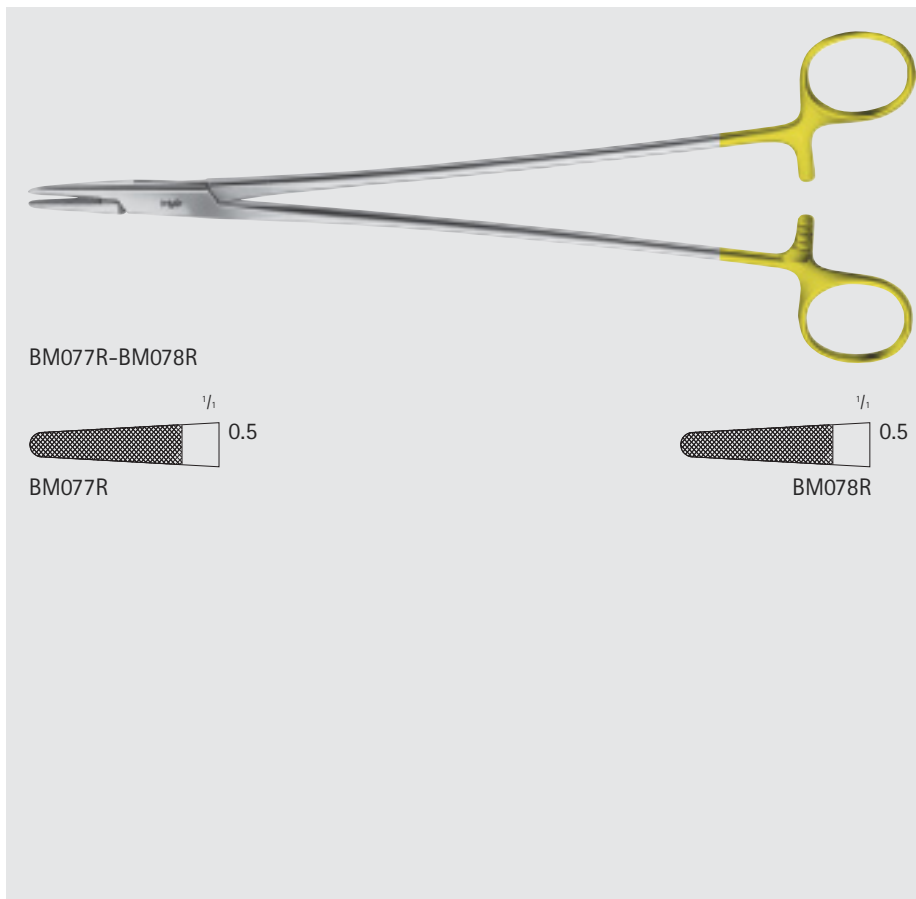

### DUROGRIP TC HEGAR Needle Holder

Catalog Number	Tip	Jaw	Length (in.)
BM077R	HVY	SERR	8
BM078R	HVY	SERR	9 3/4

BM077R-BM078R



BM077R



BM078R

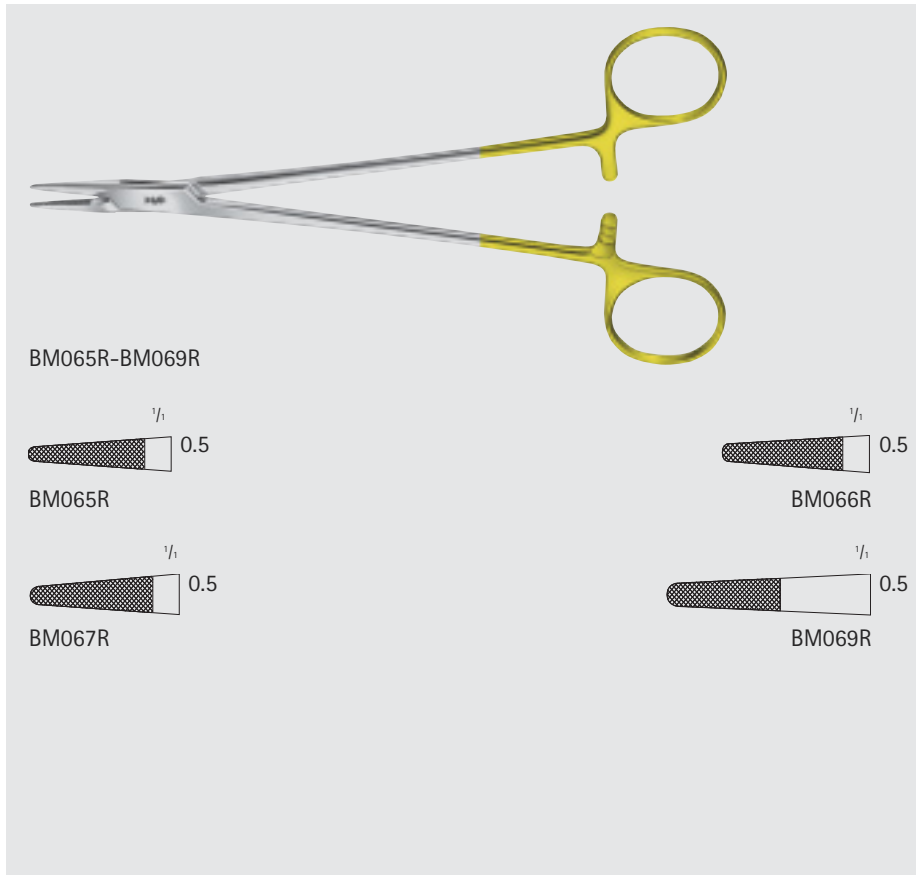

### DUROGRIP TC MAYO-HEGAR Needle Holder

Catalog Number	Jaw	Length (in.)
BM065R	SERR	6
BM066R	SERR	7 1/4
BM067R	SERR	8
BM069R	SERR	12

BM065R-BM069R



BM065R



BM066R



BM067R



BM069R

# Obstetrics/Gynecology

## Tenaculum Et Sponge Forceps

### MAIER Forceps

Catalog Number	Jaw	Length (in.)
BF056R	STR	10 1/2
BF057R	CVD	10 1/2

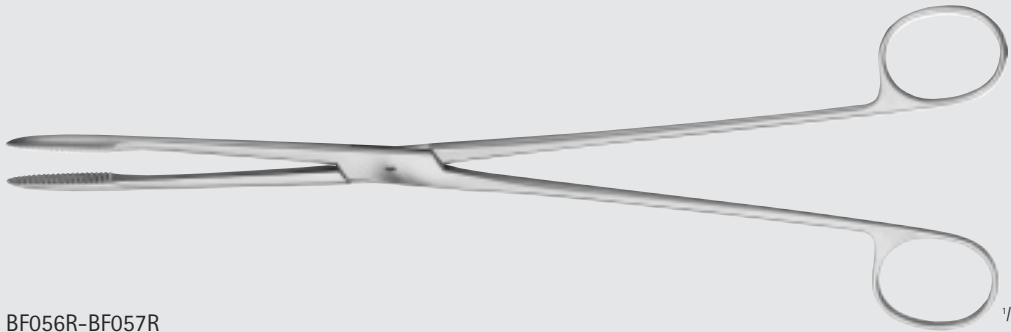

BF056R-BF057R

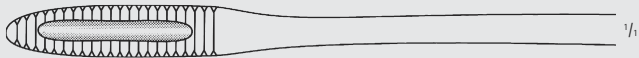

BF056R

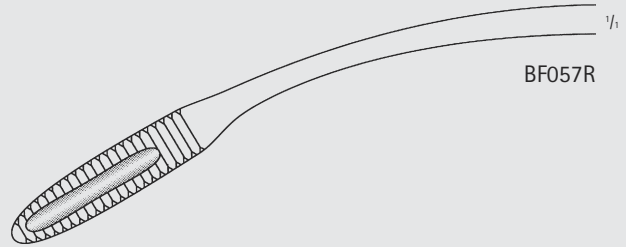

BF057R

### MAIER Forceps, W/Ratchet

Catalog Number	Jaw	Length (in.)
BF058R	STR	10 1/2
BF059R	CVD	10 1/2



BF058R-BF059R

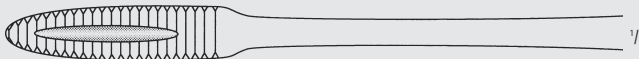

BF058R

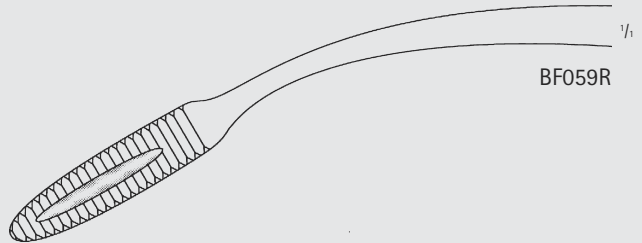

BF059R



INCHES

# Obstetrics/Gynecology

## Tenaculum & Sponge Forceps

### SIMS-MAIER Sponge Forceps, W/Ratchet

Catalog Number	Jaw	Length (in.)
BF076R	STR	11
BF077R	CVD	11



BF076R-BF077R

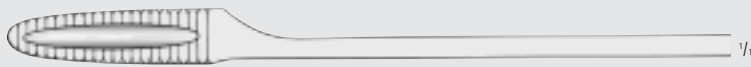

BF076R

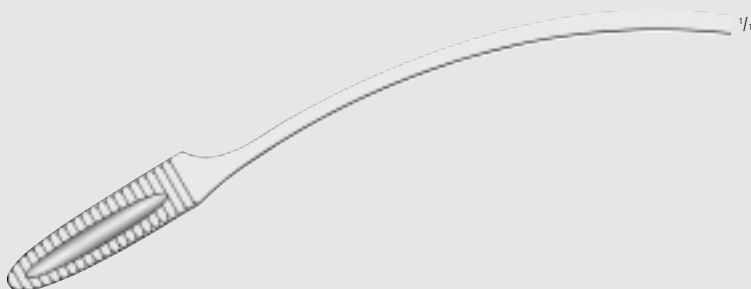

BF077R

### PELKMANN Forceps

Catalog Number	Tip	Jaw	Length (in.)
EO060R	SERR	STR	10 1/4
EO061R	SERR	CVD	10 1/4

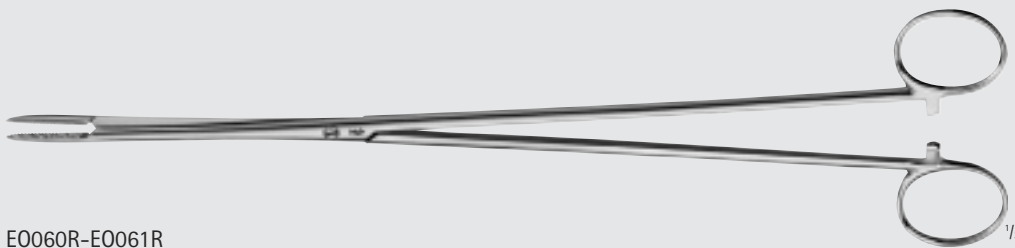

EO060R-EO061R

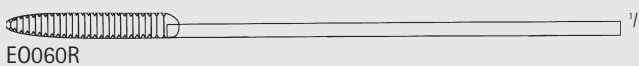

EO060R



EO061R

OB/GYN

MILLIMETERS

# Obstetrics/Gynecology

## Tenaculum Et Sponge Forceps

### BOZEMANN Forceps

Catalog Number	Shank	Jaw	Length (in.)
E0075R	S-CVD	SMOOTH	10
E0077R	S-CVD	W/GROOVE	10
E0080R	STR	SERR	10 1/4
E0082R	S-CVD	SERR	10

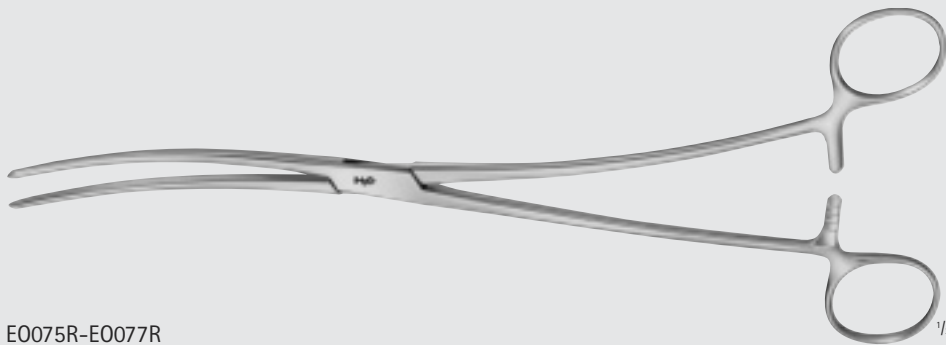

E0075R-E0077R

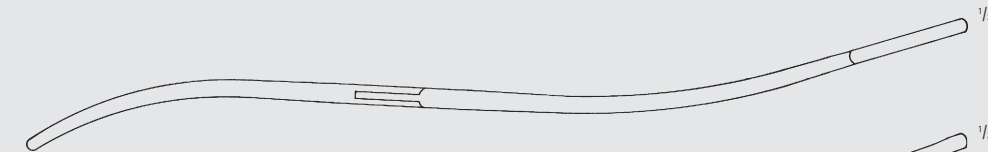

E0075R

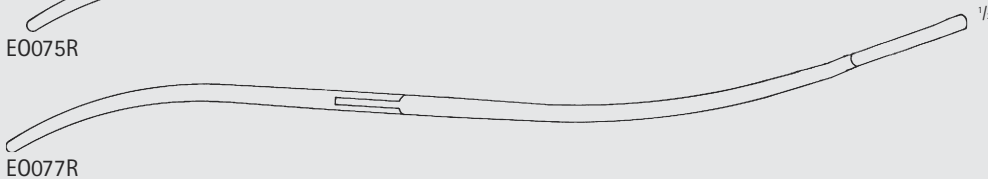

E0077R

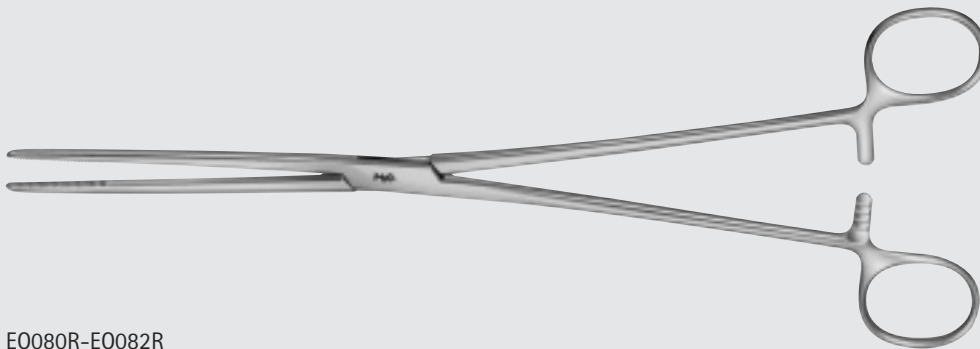

E0080R-E0082R

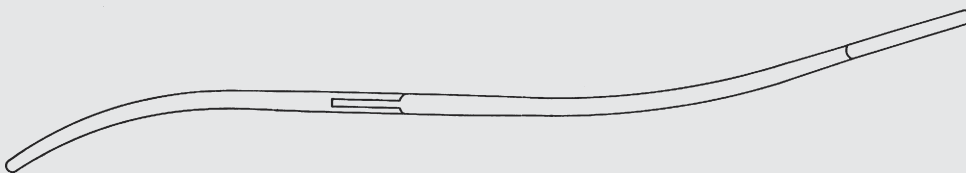

E0080R



E0082R



# Obstetrics/Gynecology

## Tenaculum & Sponge Forceps

BOZEMANN-DOUGLAS Forceps

Catalog Number	Tip	Length (in.)
EO085R	SERR	10 1/4



EO085R

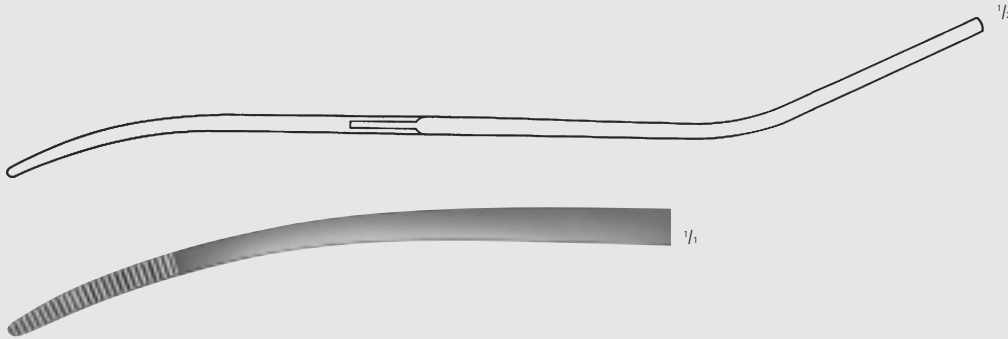

# Obstetrics/Gynecology

## Tenaculum Et Sponge Forceps



### POZZI Tenaculum Forceps, Standard

Catalog Number	Teeth	Length (in.)
EO105R	1 x 1	7

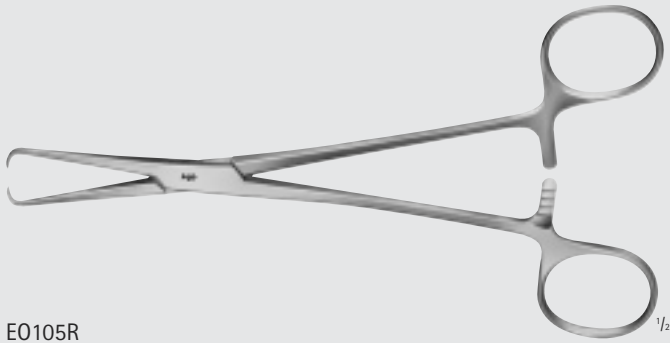

EO105R



### ADAIR Uterine Forceps

Catalog Number	Teeth	Length (in.)
EO106R	1 x 1	7 1/2

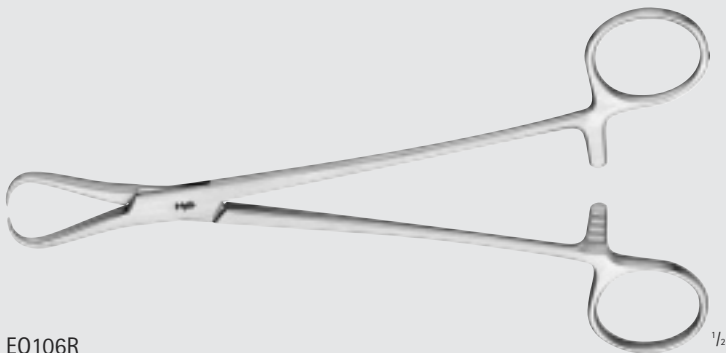

EO106R



# Obstetrics/Gynecology

## Tenaculum & Sponge Forceps

### BRAUN Tenaculum Forceps

Catalog Number	Teeth	Length (in.)
EO108R	1 x 1	10

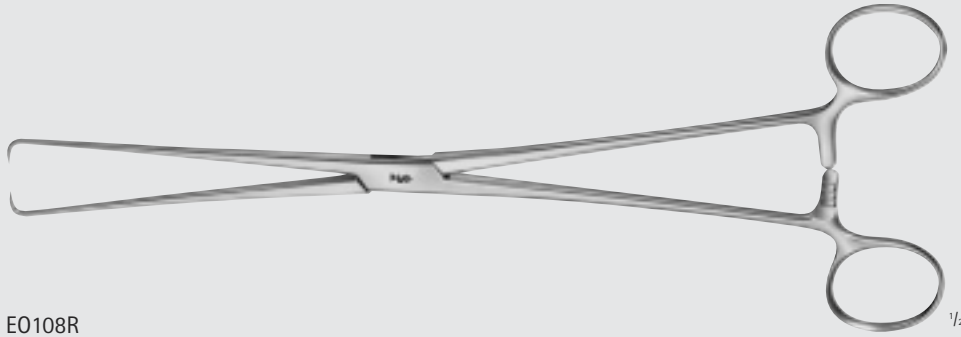

EO108R

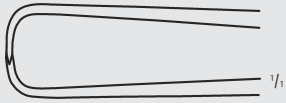

1/2

1/1

### SCHROEDER Tenaculum Forceps

Catalog Number	Shank	Teeth	Length (in.)
EO110R	STR	1 x 1	10

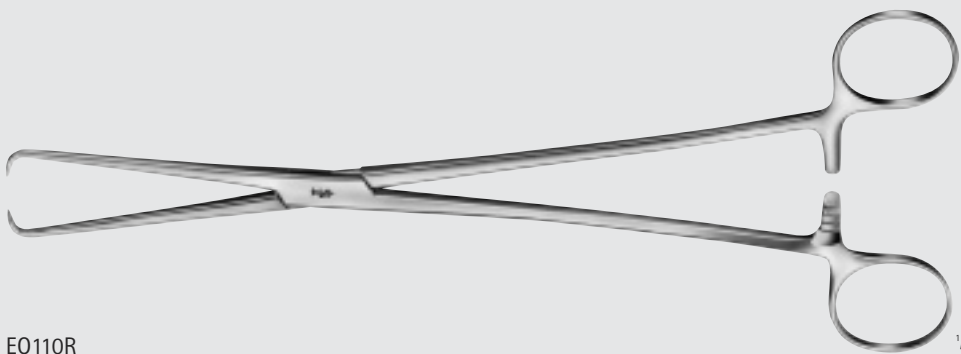

EO110R

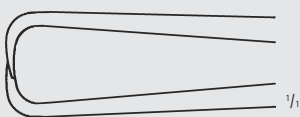

1/2

1/1

OB/GYN



SCHROEDER Tenaculum Forceps

Catalog Number	Shank	Teeth	Length (in.)
E0150R	STR	2 x 2	10
E0151R	CVD	2 x 2	10
E0163R	STR	3 x 3	10 3/4



E0150R-E0151R



E0150R



E0151R

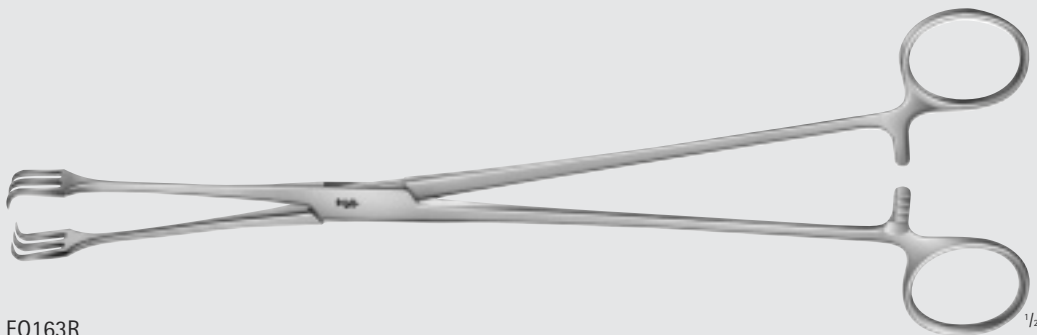

E0163R



# Obstetrics/Gynecology

## Tenaculum & Sponge Forceps

### POZZI Tenaculum Forceps, Heavy

Catalog Number	Teeth	Length (in.)
EO125R	1 x 1	10



EO125R

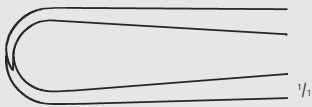

### DUPLAY Tenaculum Forceps, Delicate

Catalog Number	Teeth	Length (in.)
EO130R	1 x 1	10

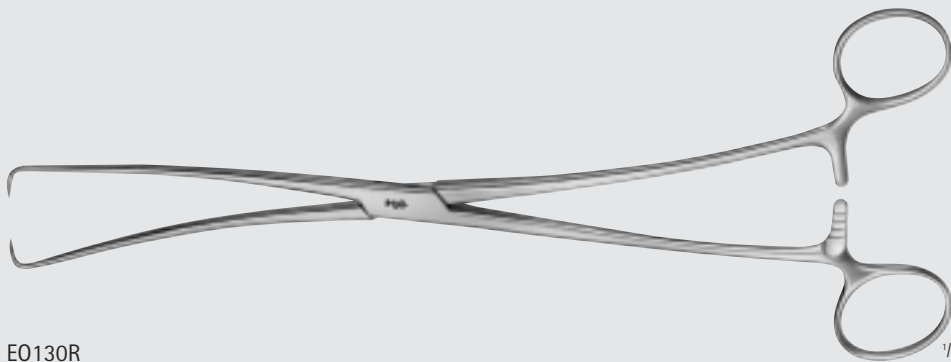

EO130R

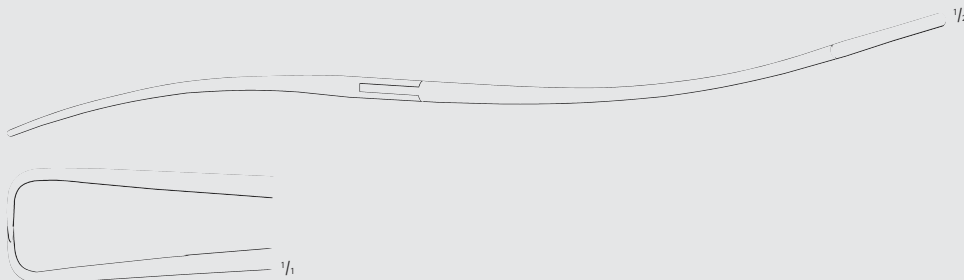

OB/GYN

# Obstetrics/Gynecology

## Tenaculum Et Sponge Forceps

### ABEL Tenaculum Forceps

Catalog Number	Teeth	Length (in.)
E0140R	1 x 1	11

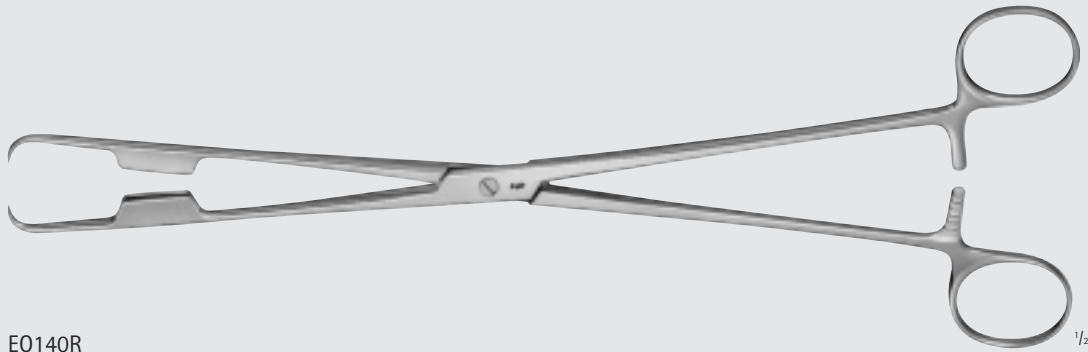

E0140R



### GORDON Uterine Vulsellum Forceps

Catalog Number	Teeth	Length (in.)
MB272R	3 x 3	8 3/4



MB272R



INCHES

# Obstetrics/Gynecology

## Tenaculum & Sponge Forceps

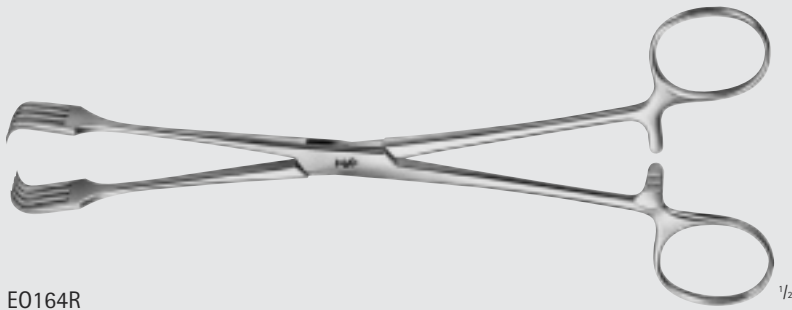

EO164R

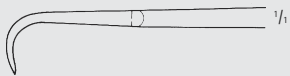

### CZERNY Uterine Tenaculum Forceps

Catalog Number	Teeth	Length (in.)
EO164R	4 x 4	8

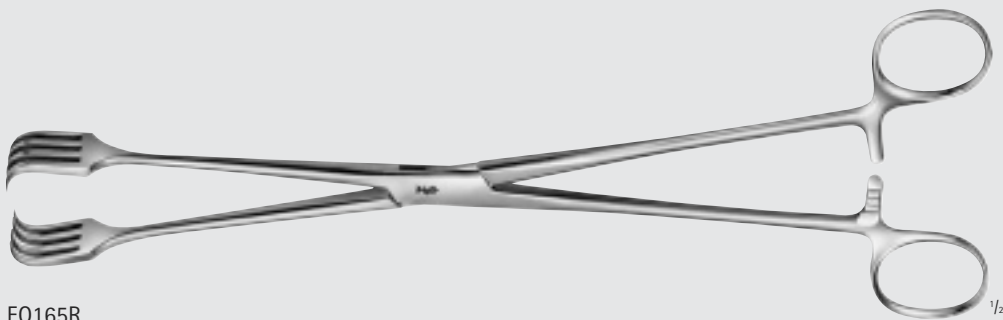

EO165R

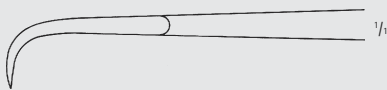

### AESCULAP-PRATT Tenaculum Forceps

Catalog Number	Teeth	Length (in.)
EO165R	4 x 4	10 1/4



OB/GYN

PRATT Tenaculum Forceps

Catalog Number	Teeth	Length (in.)
E0166R	4 x 4	10 3/4



E0166R

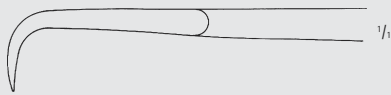

TEALE Tenaculum Forceps

Catalog Number	Teeth	Length (in.)
E0180R	3 x 4	9

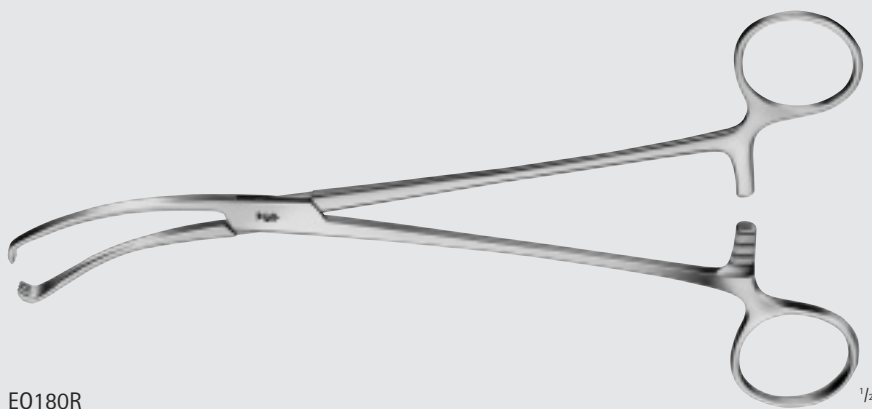

E0180R



INCHES

# Obstetrics/Gynecology

## Tenaculum & Sponge Forceps

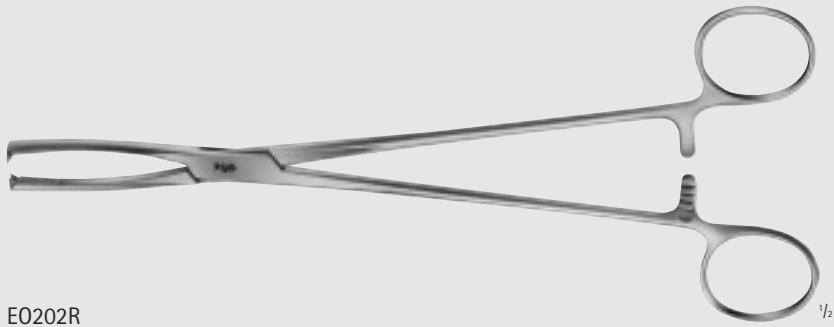

E0202R

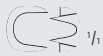

### JACOBS Vulsellum Forceps

Catalog Number	Teeth	Length (in.)
E0202R	2 x 2	8 1/2

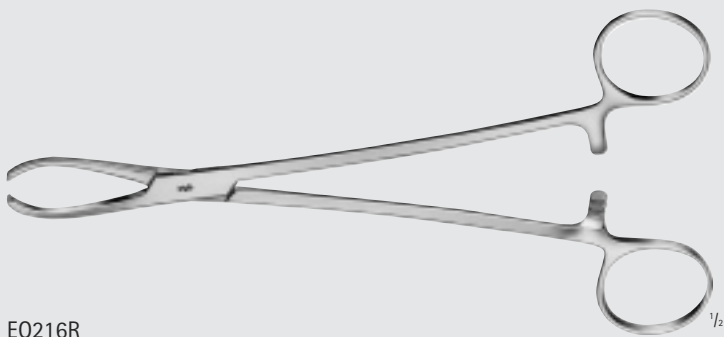

E0216R

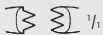

### LITTLEWOOD Tenaculum Forceps

Catalog Number	Teeth	Length (in.)
E0216R	2 x 3	7 1/4

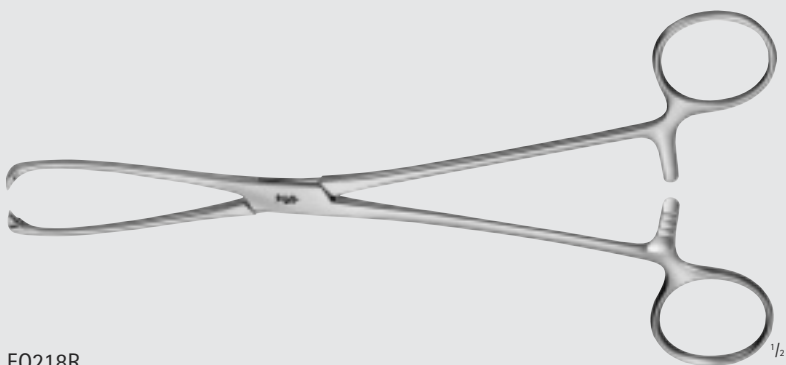

E0218R



### MUSEUX Tenaculum Forceps, Small

Catalog Number	Teeth	Length (in.)
E0218R	2 x 2	8

OB/GYN

# Obstetrics/Gynecology

## Tenaculum Et Sponge Forceps

### MUSEUX Tenaculum Forceps

Catalog Number	Jaw	Length (in.)
E0220R	STR	9 1/2
E0221R	STR	9 1/2
E0222R	STR	9 1/2

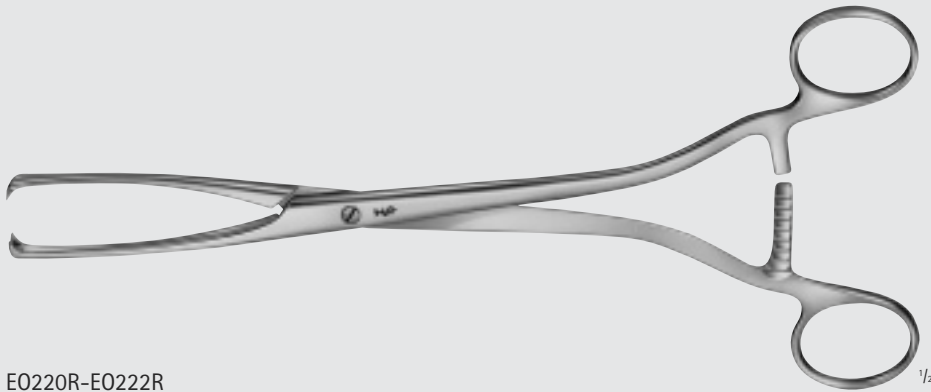

E0220R-E0222R

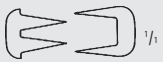

E0220R



E0221R



E0222R

### MUSEUX Tenaculum Forceps

Catalog Number	Jaw	Length (in.)
E0225R	CVD	9 1/2



E0225R



INCHES

# Obstetrics/Gynecology

## Tenaculum & Sponge Forceps

### MUSEUX Tenaculum Forceps

Catalog Number	Jaw	Length (in.)
E0240R	STR	10 1/2
E0242R	STR	10 1/2



E0240R-E0242R



E0240R

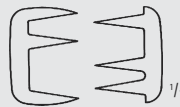

E0242R

### FLETCHER-VAN DOREN Uterine Polyp, Sponge Holding Forceps

Catalog Number	Length (in.)
MB273R	9 1/2

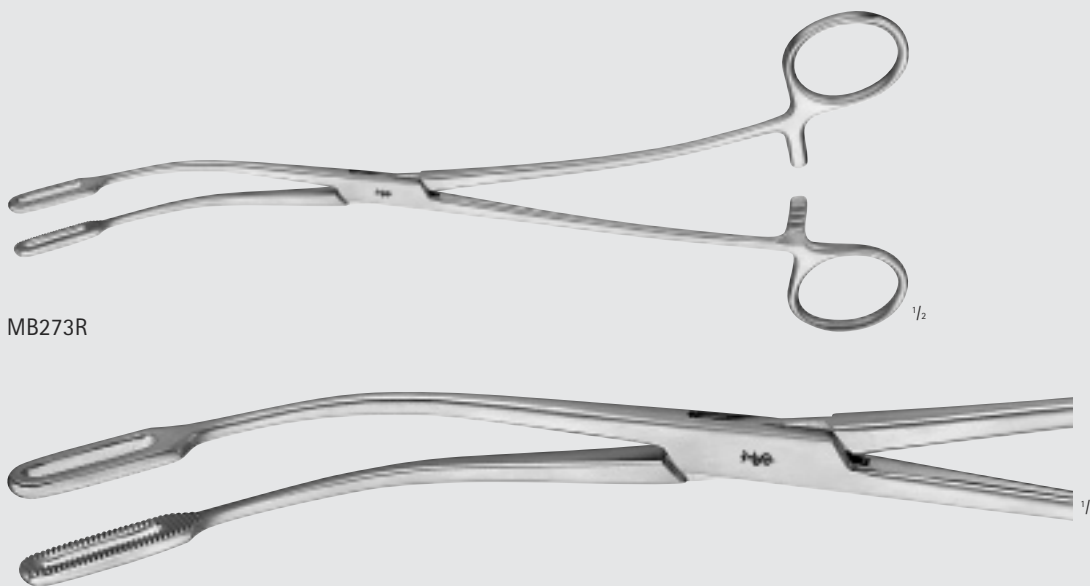

MB273R

OB/GYN



HEYWOOD-SMITH Polyp Forceps

Catalog Number	Length (in.)
EO310R	10

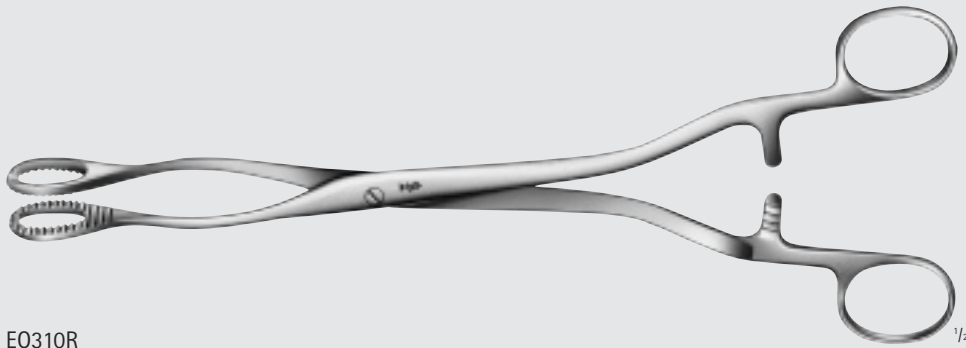

EO310R



NOTO Polyp Forceps

Catalog Number	Length (in.)
EO315R	11

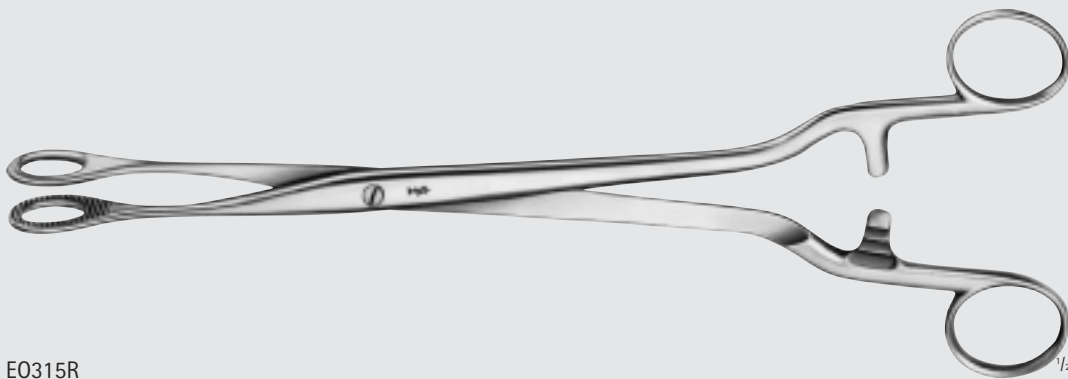

EO315R

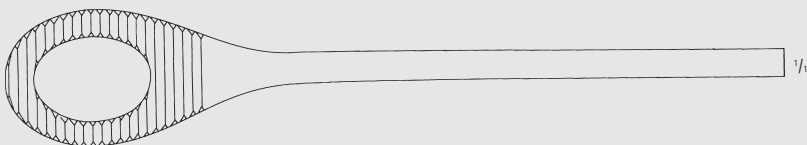

INCHES

# Obstetrics/Gynecology

## Ovum Forceps

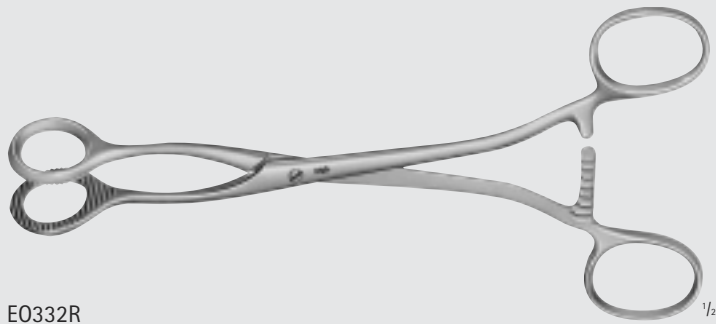

EO332R

1/2

### DOYEN Ovum Forceps

Catalog Number	Length (in.)
EO332R	7 1/4

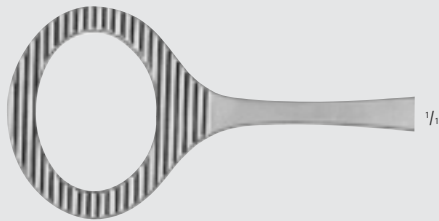

1/4

### Atraumatic Ovum Forceps

Catalog Number	Tip	Length (in.)
EO338R	SM	10

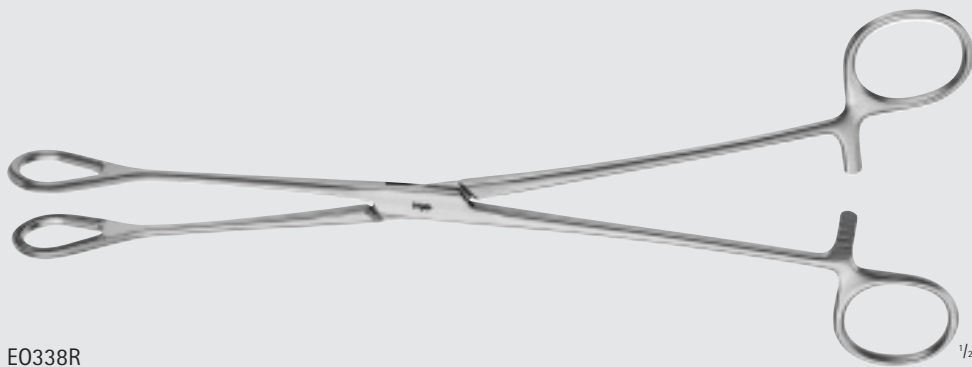

EO338R

1/2

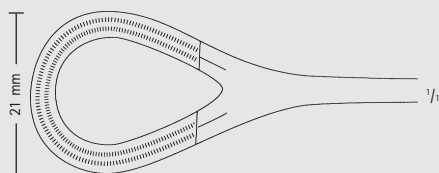

1/4



Obstetrics/Gynecology  
Uterine Elevating Forceps

DARTIGUES Elevating Forceps

Catalog Number	Length (in.)
E0407R	10



E0407R

SOMER Uterine Elevating Forceps

Catalog Number	Length (in.)
E0415R	9 1/4

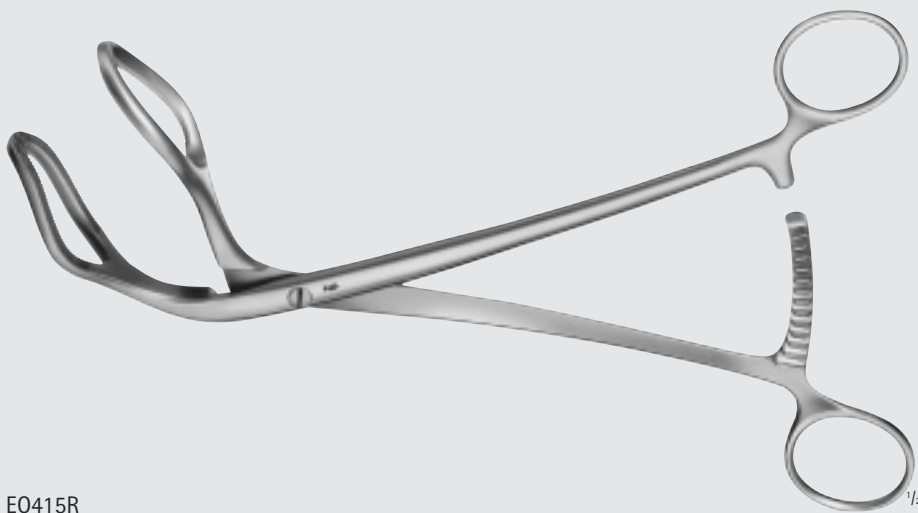

E0415R



INCHES

# Obstetrics/Gynecology

## Uterine Elevating Forceps

COLLIN Uterine Elevating Forceps,  
Movable Jaw

Catalog Number	Blade	Length (in.)
E0420R	STR	10 1/2

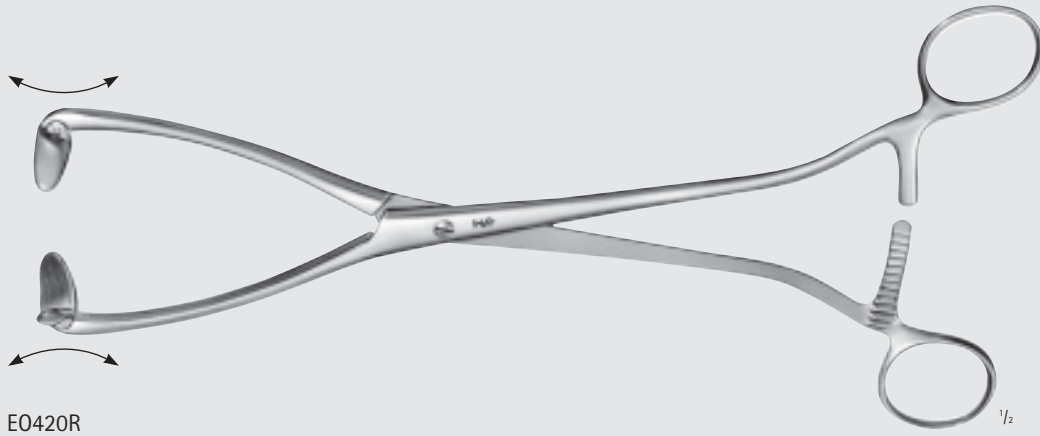

E0420R

1/2



# Obstetrics/Gynecology

## Uterine Elevating Forceps, Myoma Screws

### HULKA-KENWICK Uterine Elevating Forceps

Catalog Number	Length (in.)
E0422R	10 3/4

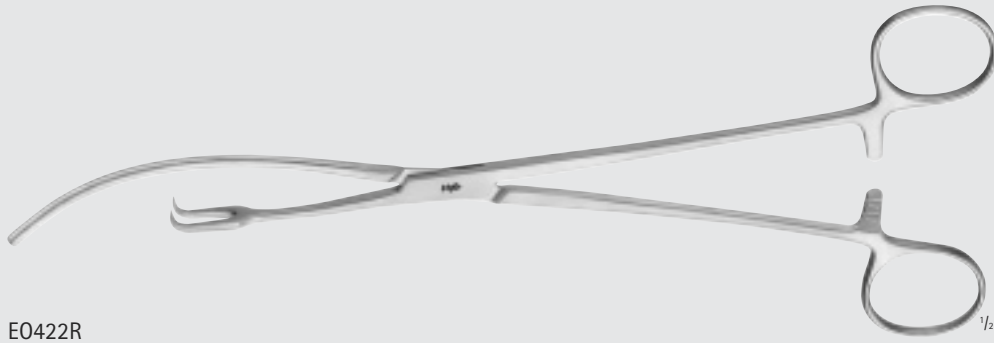

E0422R



### DOYEN Myoma Screw

Catalog Number	Length (in.)
E0433R	6
E0435R	7 1/2



E0433R



E0435R



INCHES

# Obstetrics/Gynecology

## Obstetrical Forceps



OB/GYN

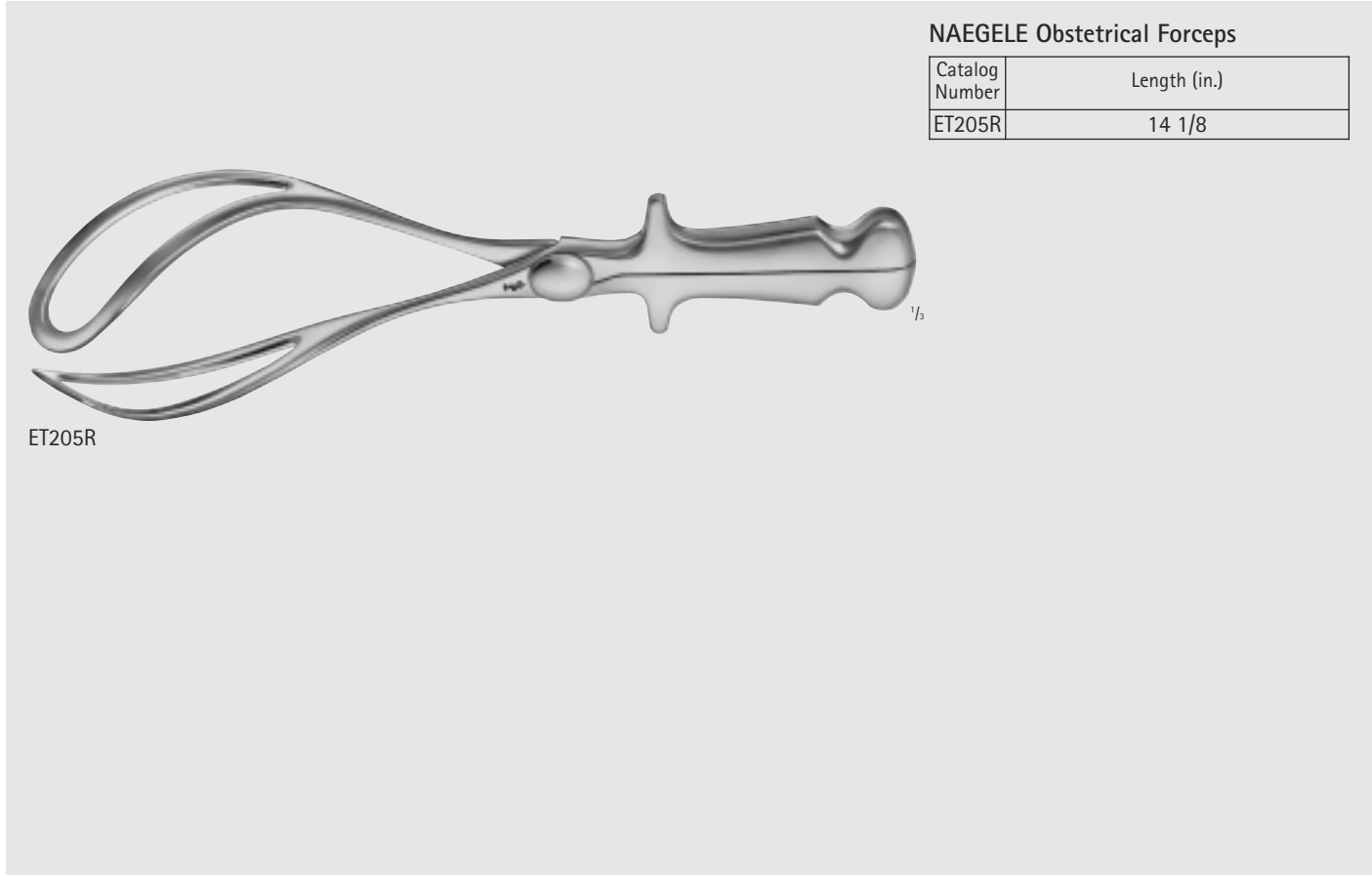

ET205R

### NAEGELE Obstetrical Forceps

Catalog Number	Length (in.)
ET205R	14 1/8



ET210R

### KIELLAND Obstetrical Forceps

Catalog Number	Length (in.)
ET210R	16 3/4

SIMPSON-BRAUN Obstetrical Forceps

Catalog Number	Length (in.)
ET220R	12
ET221R	14

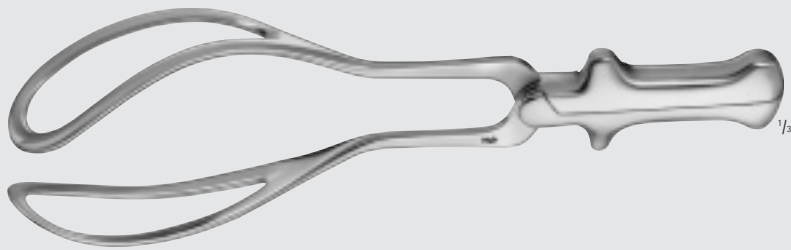

ET220R



ET221R

PIPER Obstetrical Forceps, F/Breach

Catalog Number	Length (in.)
ET237R	17 1/2



ET237R

SIMPSON C-Section Forceps

Catalog Number	Length (in.)
ET245R	9 1/4



ET245R



# Obstetrics/Gynecology

## Obstetrical Forceps



**BARNES-NEVILLE Obstetrical Forceps,  
With Traction Handle**

Catalog Number	Length (in.)
ET255R	17

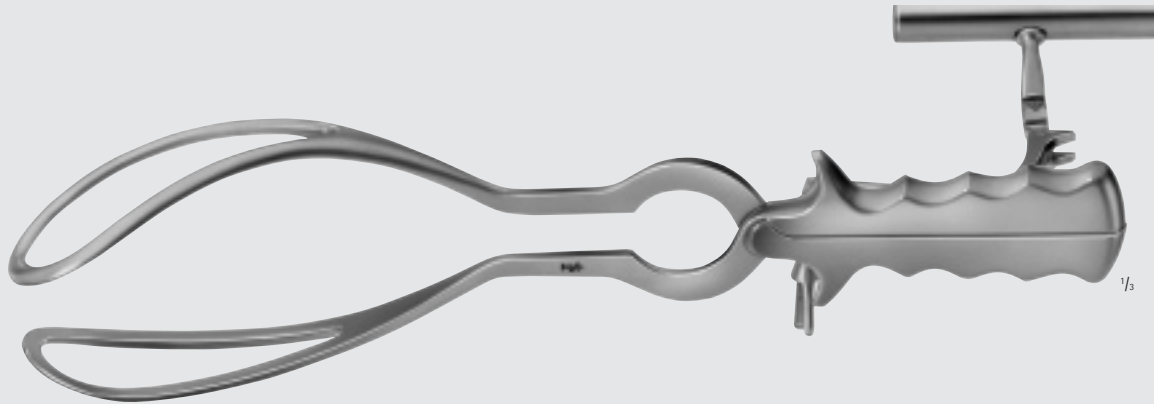

ET255R

**LUIKART-SIMPSON Obstetrical Forceps**

Catalog Number	Length (in.)
MB298R	14



MB298R

**LUIKART-MC LANE Obstetrical Forceps**

Catalog Number	Length (in.)
MB299R	15 1/2



MB299R



Obstetrics/Gynecology  
C-Section, Forceps, Obstetric Lever

GREEN-ARMYTAGE Forceps,  
F/C-Section

Catalog Number	Length (in.)
ET269R	8 3/4

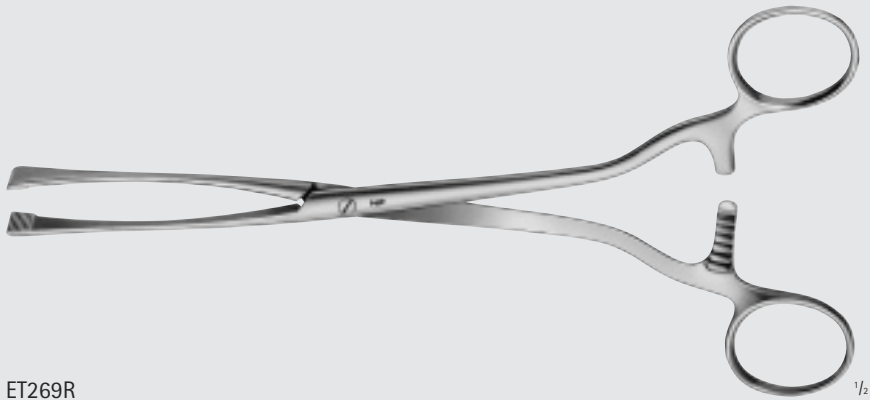

ET269R



SELLHEIM Obstetric Lever

Catalog Number	Blade	Length (in.)
ET270R	OPEN	12



ET270R

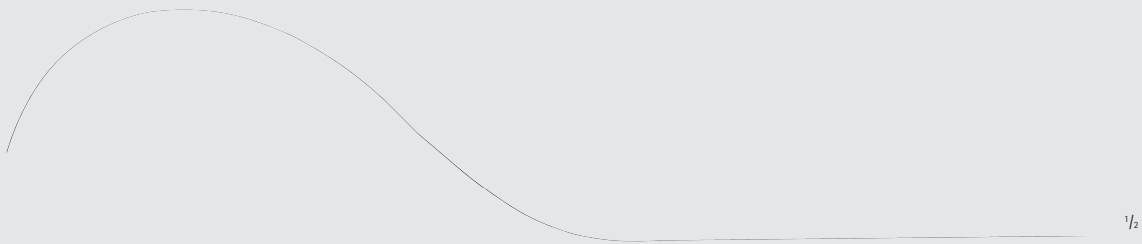

INCHES

# Obstetrics/Gynecology

## Placenta & Ovum Forceps

### WINTER Placenta and Ovum Forceps, W/O Ratchet

Catalog Number	Size	Jaw	Length (in.)
ET301R	#1	STR	11 1/2
ET302R	#2	STR	11 1/2



ET301R-ET302R



ET301R



ET302R



WINTER Placenta and Ovum Forceps,  
W/O Ratchet  
(continued)

Catalog Number	Size	Jaw	Length (in.)
ET306R	#1	CVD	11 1/2
ET307R	#2	CVD	11 1/2
ET308R	#3	CVD	11 1/2

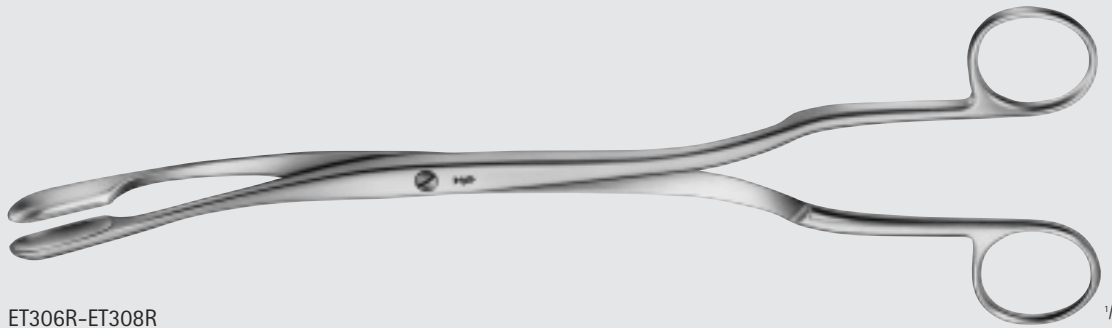

ET306R-ET308R

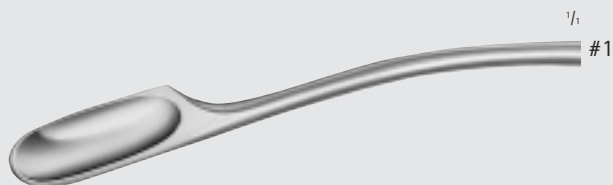

ET306R



ET307R



ET308R



# Obstetrics/Gynecology

## Placenta Et Ovum Forceps

### WINTER Placenta and Ovum Forceps, W/Ratchet

Catalog Number	Size	Jaw	Length (in.)
ET315R	#2	CVD	11 1/2
ET316R	#3	CVD	11 1/2

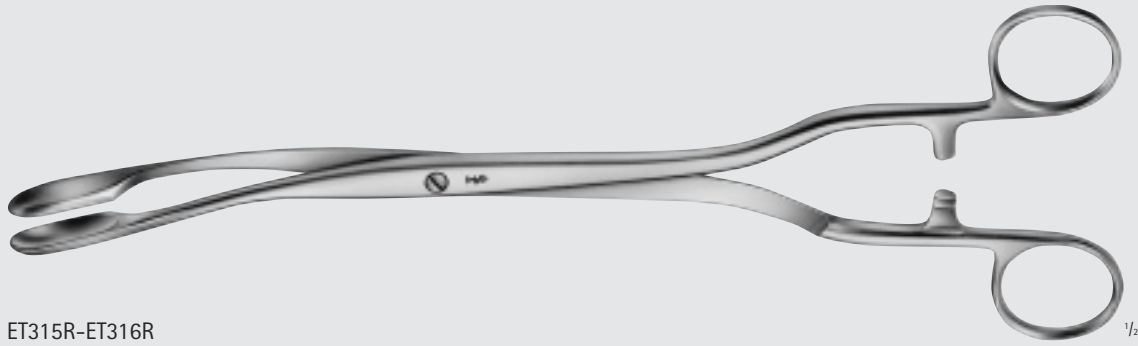

ET315R-ET316R



ET315R



ET316R



SAENGER Placenta and Ovum Forceps,  
W/O Ratchet

Catalog Number	Jaw	Length (in.)
ET325R	CVD	11 1/4

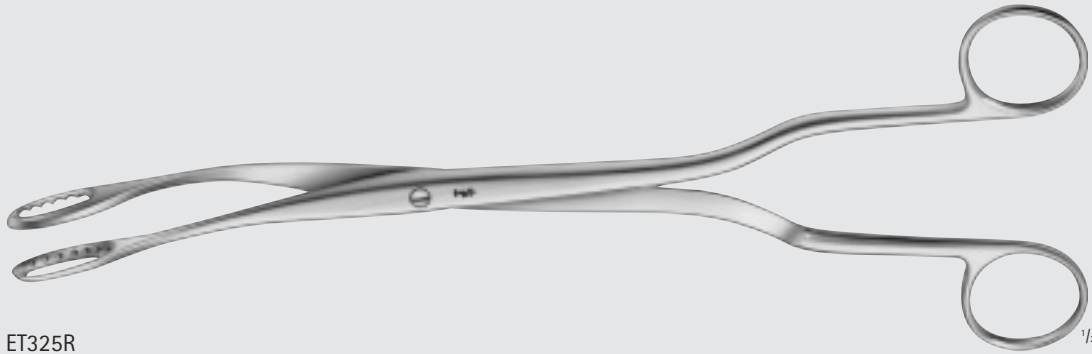

SAENGER Placenta and Ovum Forceps,  
W/Ratchet

Catalog Number	Jaw	Length (in.)
ET326R	STR	10 3/4

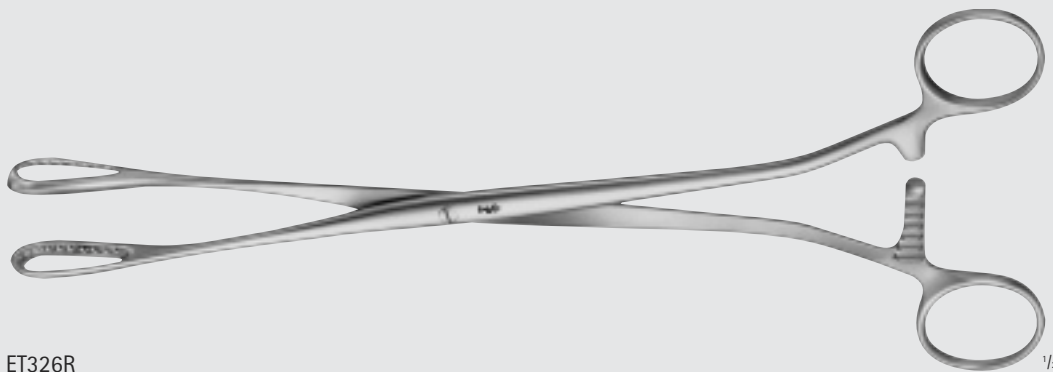

OB/GYN

# Obstetrics/Gynecology

## Placenta & Ovum Forceps

### SAENGER Placenta and Ovum Forceps, W/Ratchet (continued)

Catalog Number	Jaw	Length (in.)
ET327R	CVD	10 1/2

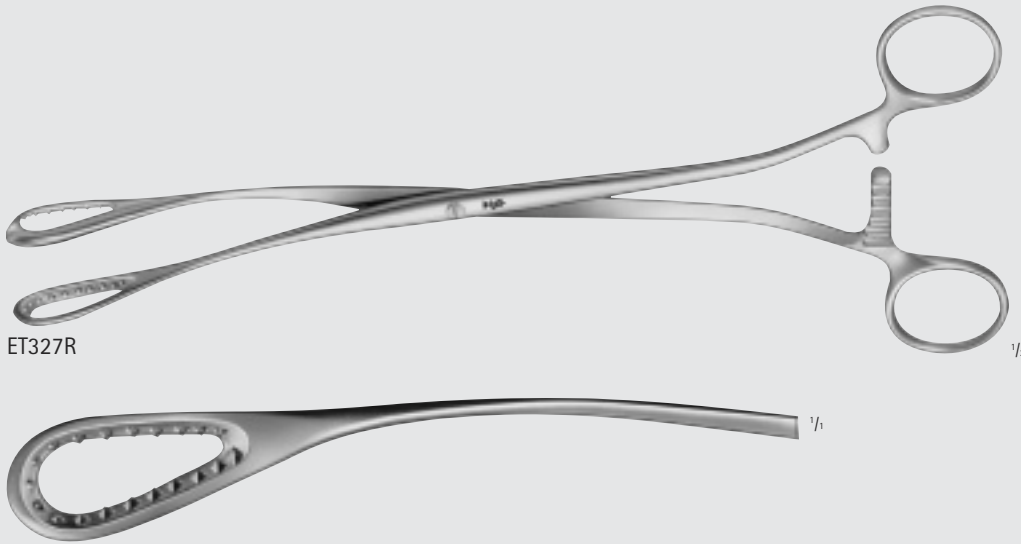

### MC CLINTOCK Placenta and Ovum Forceps

Catalog Number	Length (in.)
ET329R	9 1/2

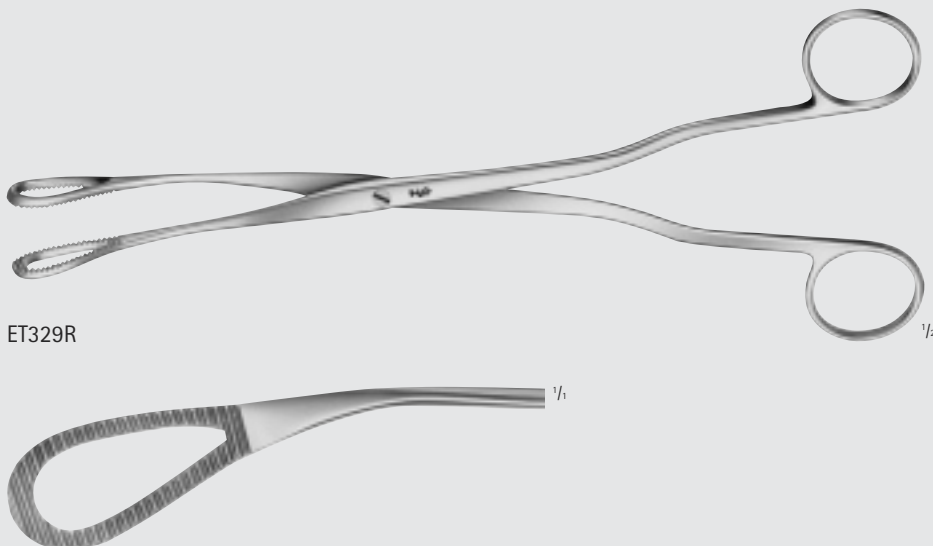

OB/GYN

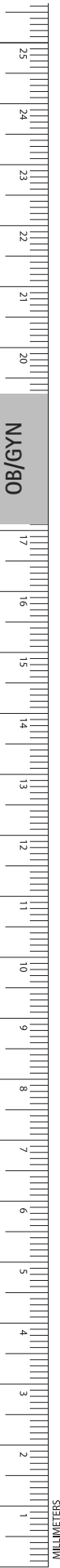

THOMS-GAYLOR Biopsy Forceps

Catalog Number	Length (in.)
ER050R	9 1/2

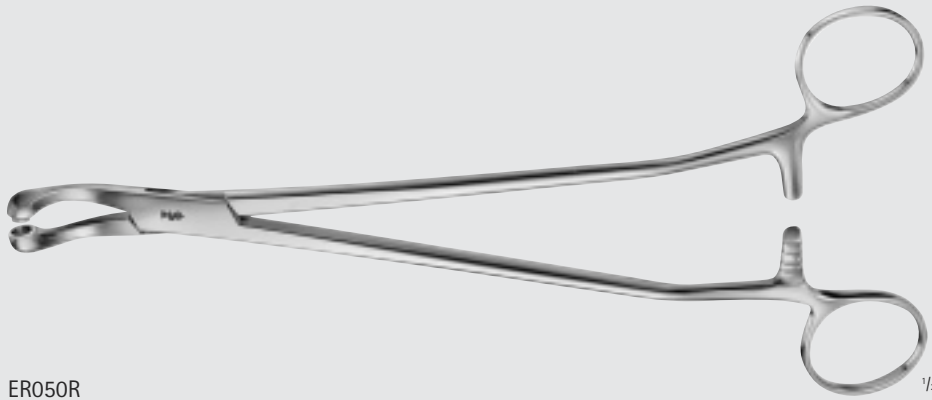

ER050R

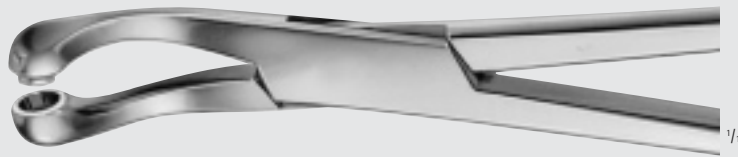

# Obstetrics/Gynecology

## Biopsy Forceps



**SCHUMACHER Biopsy Forceps**

Catalog Number	Tip	Length (in.)
ER061R	SM	9 1/2
ER062R	LRG	9 1/2

ER061R-ER062R

1/4

1/4  
ER061R

1/4  
ER062R

**SCHUMACHER Biopsy Rongeur**

Catalog Number	Tip	Length (in.)
ER063R	SM	9 1/2
ER064R	LRG	9 1/2

240 mm, 9 1/2"

ER063R-ER064R

1/4

1/4  
ER063R

1/4  
ER064R



**BERGER Biopsy Forceps**

Catalog Number	Shaft Length (in.)
ER066R	8 1/4

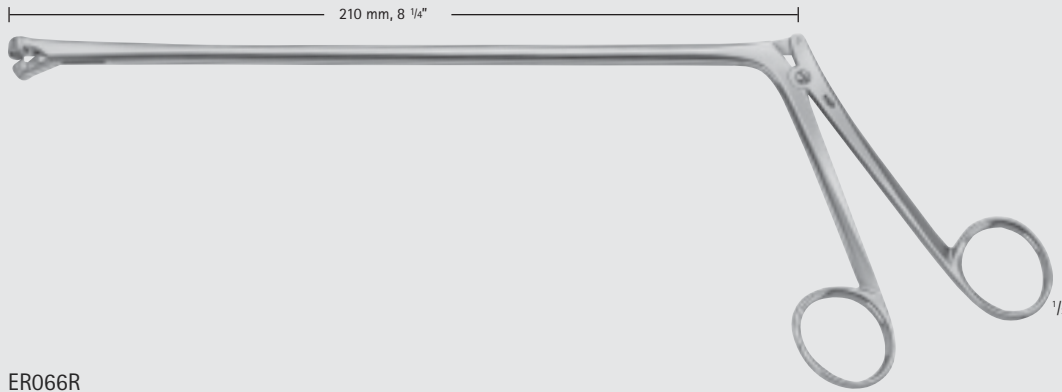

ER066R



**TISCHLER Cervical Biopsy Punch Forceps**

Catalog Number	Length (in.)
ER068R	8 1/4

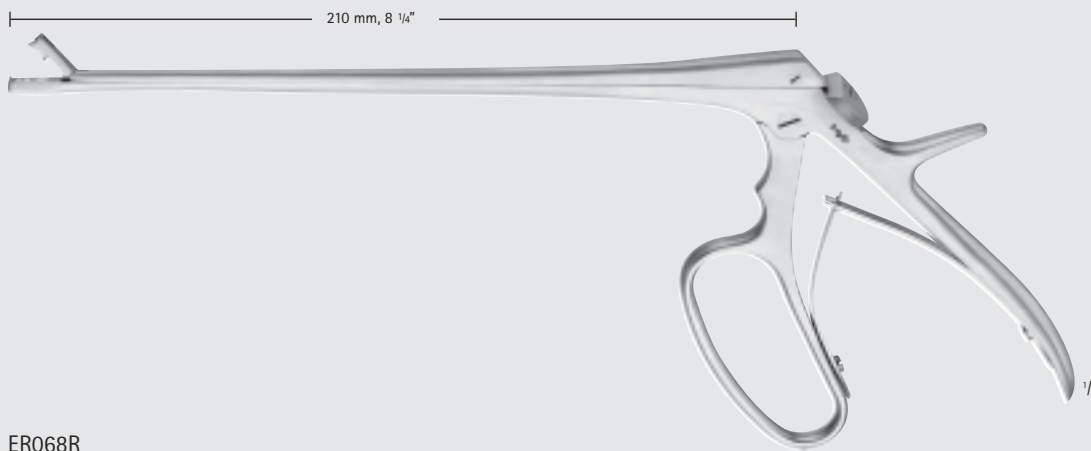

ER068R



INCHES

# Obstetrics/Gynecology

## Biopsy Forceps



### KEVORKIAN-YOUNGE Biopsy Forceps

Catalog Number	Tip Size (mm)	Length (in.)
ER080R	8.5 x 3.5	10



ER080R



### EPPENDORF Biopsy Forceps

Catalog Number	Tip Size (mm)	Length (in.)
ER070R	8 x 4	8

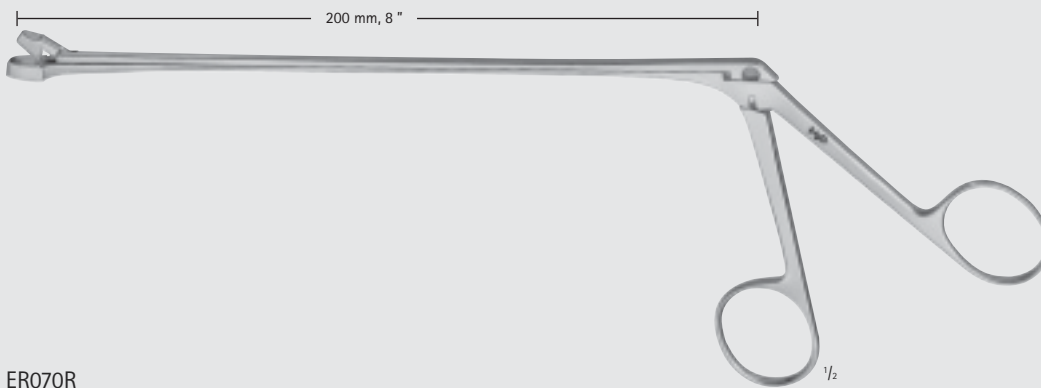

ER070R



PHANEUF Hysterectomy Forceps

Catalog Number	Jaw	Length (in.)
BJ500R	STR	8 1/4
BJ501R	ANG	8



BJ500R-BJ501R

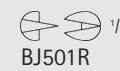

HOLZBACH Hysterectomy Forceps

Catalog Number	Jaw	Length (in.)
BJ510R	STR	9 3/4
BJ511R	CVD	9 3/4

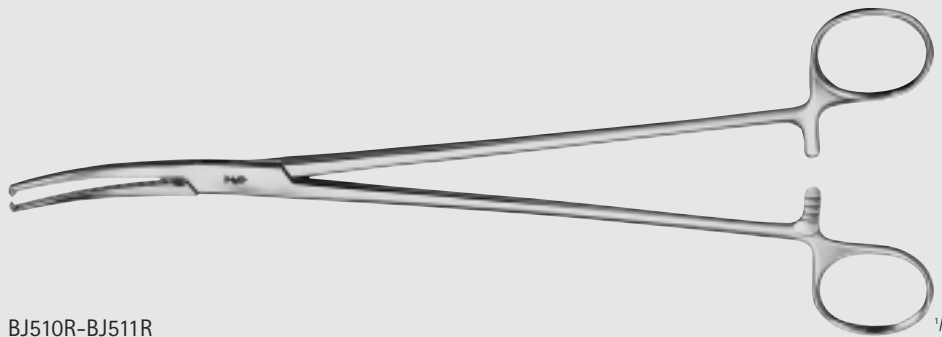

BJ510R-BJ511R

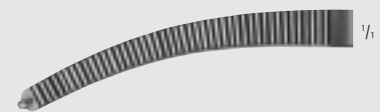
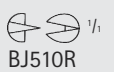

HEANEY-REZEK Hysterectomy Forceps

Catalog Number	Jaw	Length (in.)
BJ524R	STR	8 1/4

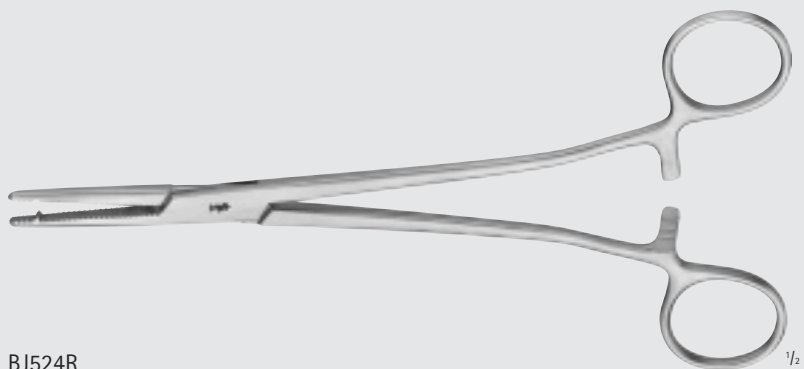

BJ524R



# Obstetrics/Gynecology

## Clamps



OB/GYN

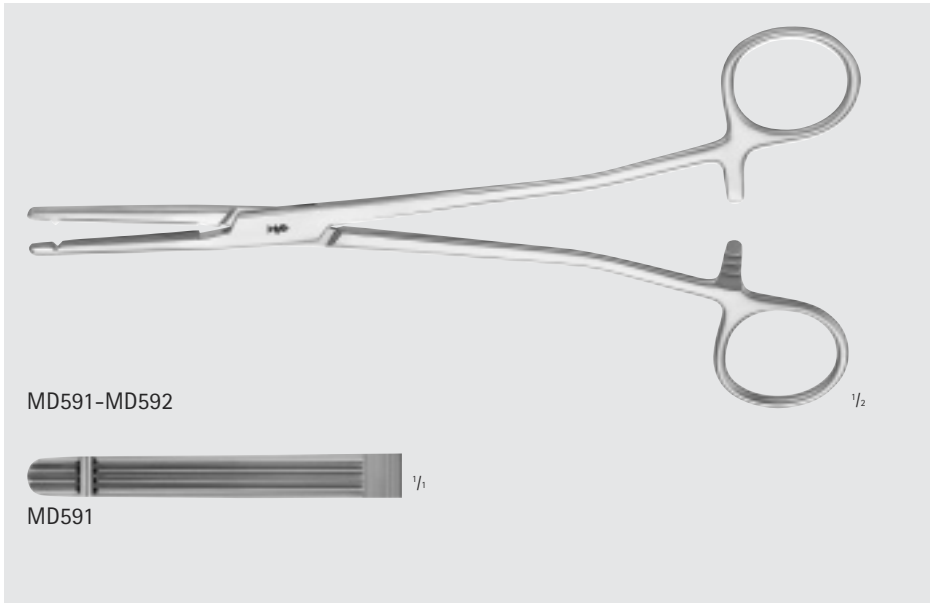

MD591-MD592

MD591

MD592

### HEANEY-BALLENTINE Hysterectomy Forceps

Catalog Number	Jaw	Length (in.)
MD591	STR	8 1/2
MD592	CVD	8 1/2

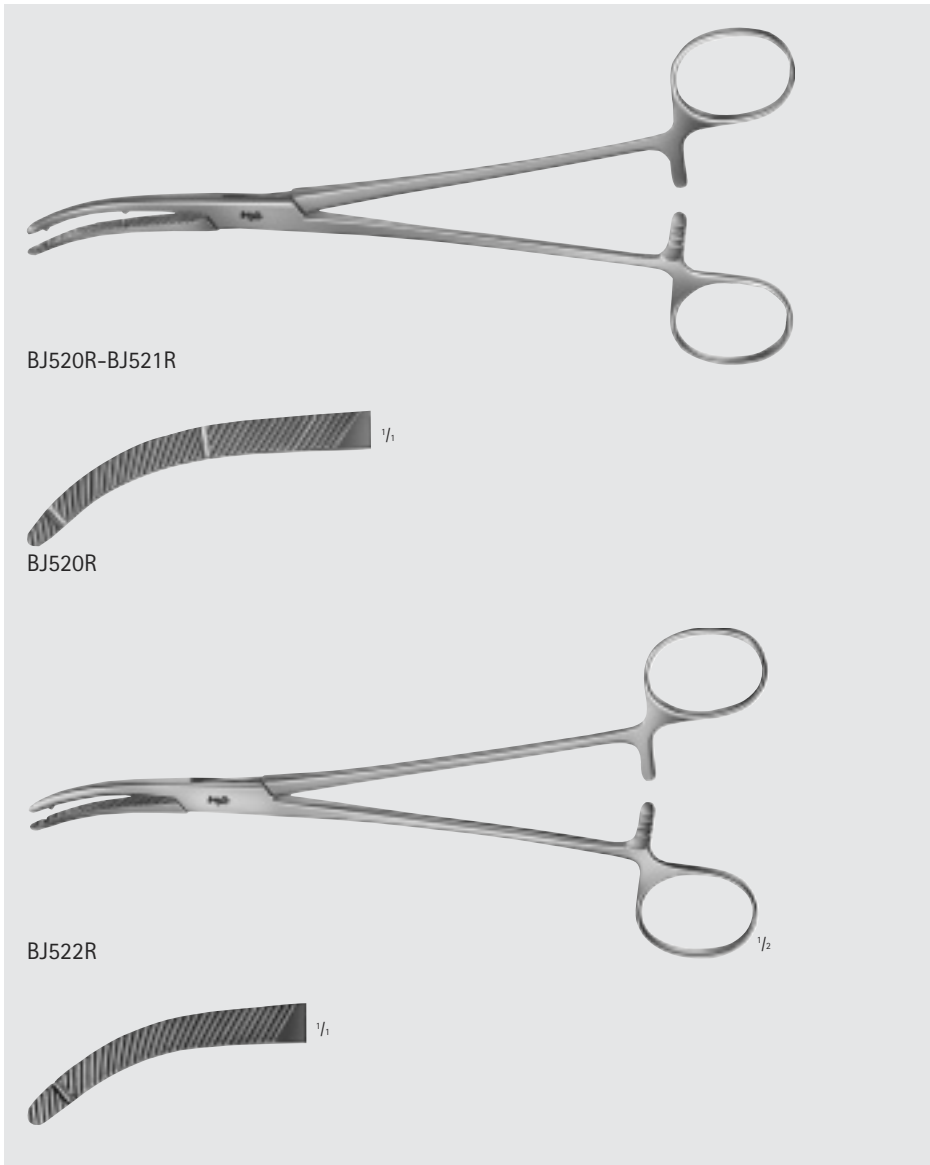

BJ520R-BJ521R

BJ520R

BJ521R

BJ522R

### HEANEY Atraumatic Hysterectomy Forceps

Catalog Number	Jaw	Length (in.)
BJ520R	CVD	8
BJ521R	CVD	9 3/4
BJ522R	CVD	7 3/4

**HEANEY Atraumatic Hysterectomy Forceps**

Catalog Number	Jaw	Length (in.)
BJ530R	STR	9
BJ531R	CVD	8 3/4
BJ532R	CVD	8 1/2

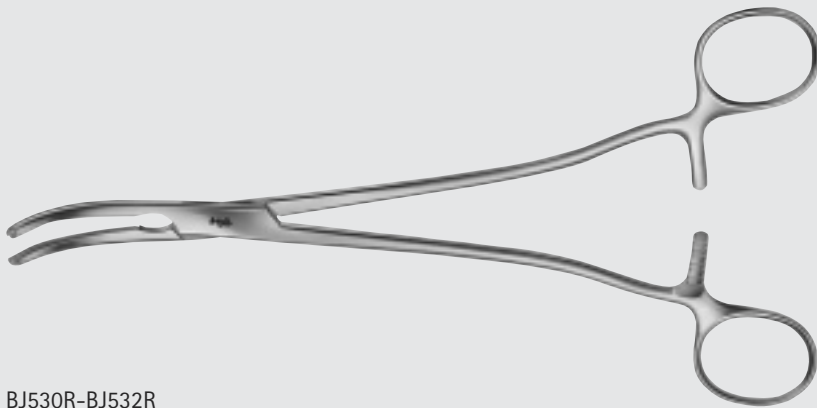

BJ530R-BJ532R

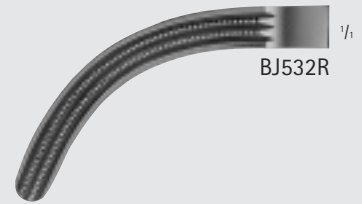

**WIENER Hysterectomy Forceps**

Catalog Number	Tip	Jaw	Length (in.)
BJ526R	GROOVED	CVD	8 3/4
BJ527R	SMOOTH	CVD	9 1/2

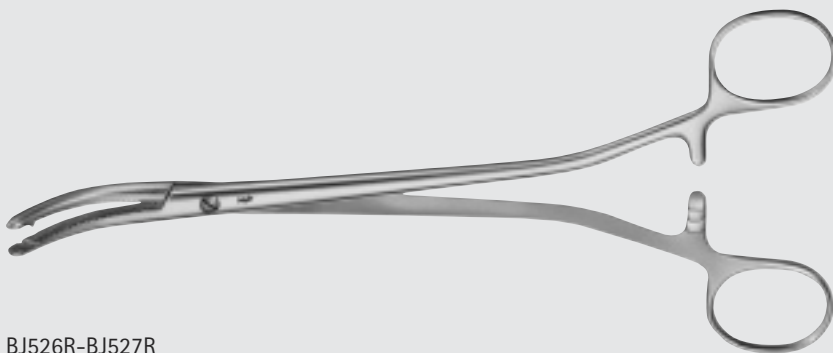

BJ526R-BJ527R

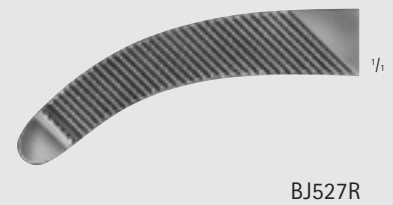
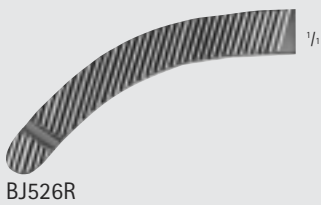

OB/GYN

INCHES

# Obstetrics/Gynecology

## Clamps

### WERTHEIM Atraumatic Parametrium Clamp

Catalog Number	Jaw	Length (in.)
BJ550R	STR	10
BJ551R	SLT-CVD	9 3/4
BJ552R	CVD	9 1/2
BJ553R	UP-CVD	8 3/4

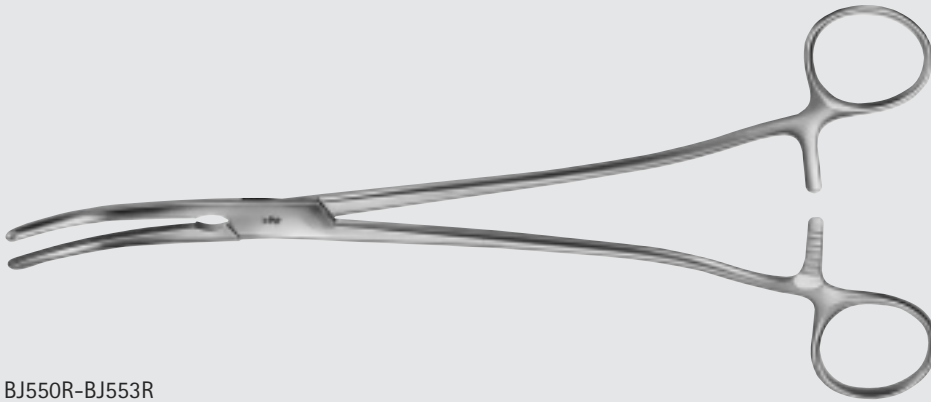

BJ550R-BJ553R



BJ550R



BJ551R



BJ552R



BJ553R

OB/GYN

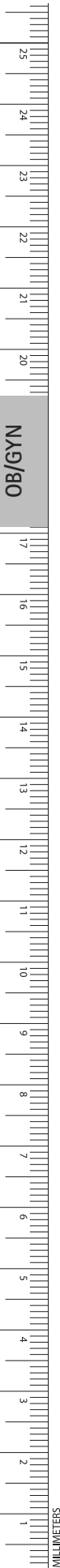

WERTHEIM Parametrium Clamp

Catalog Number	Jaw	Length (in.)
BJ576R	CVD	10 1/4

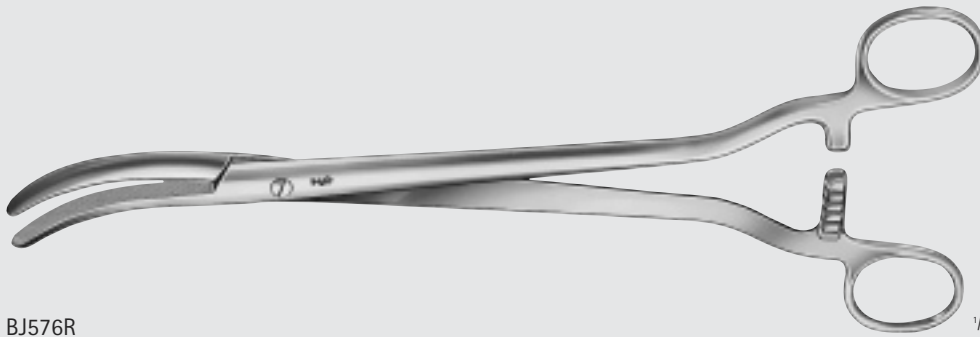

BJ576R

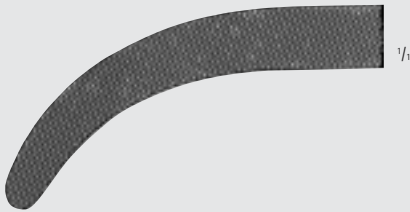

WERTHEIM Hysterectomy Forceps

Catalog Number	Jaw	Length (in.)
BJ574R	CVD	10

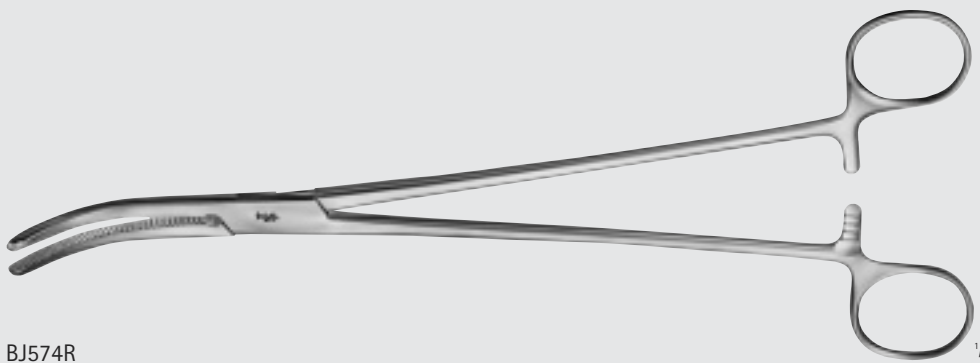

BJ574R

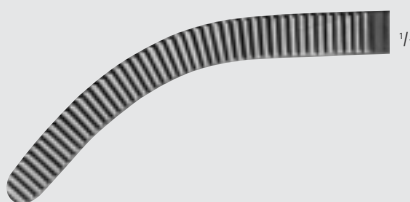

INCHES

# Obstetrics/Gynecology

## Clamps

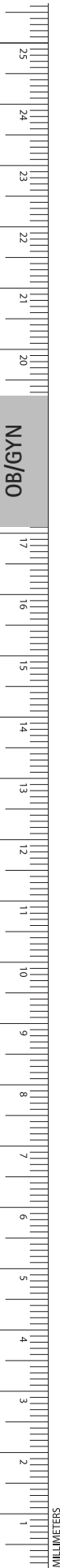

OB/GYN

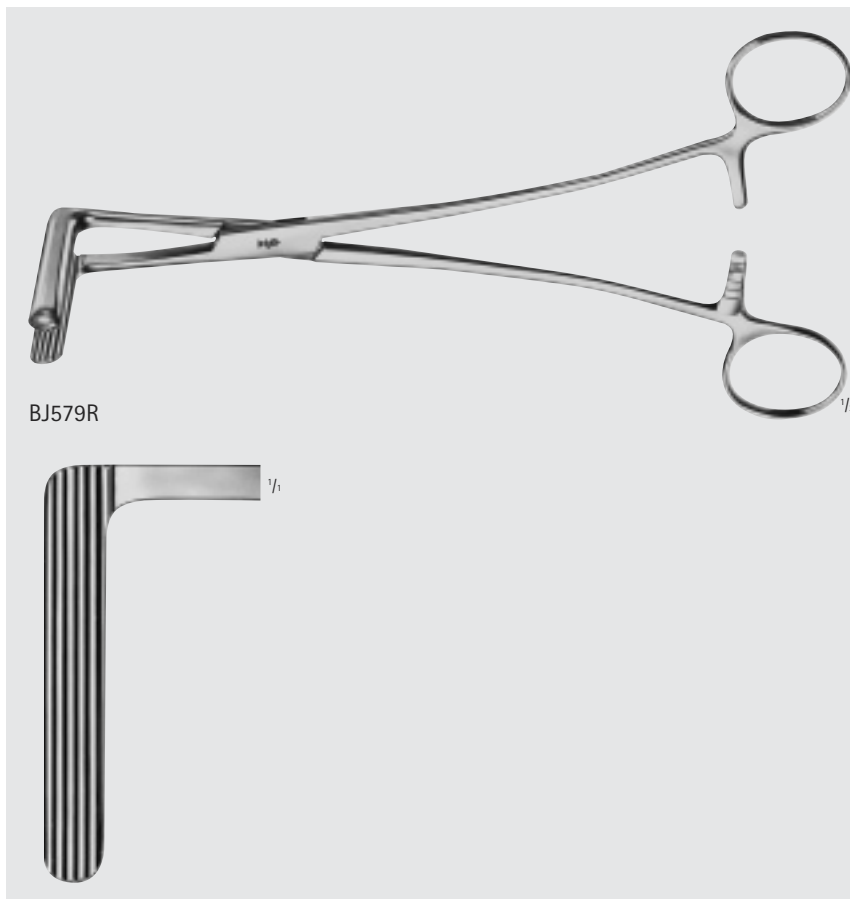

BJ579R

### WERTHEIM-CULLEN Clamp

Catalog Number	Jaw	Length (in.)
BJ579R	RT-ANG	8 1/2

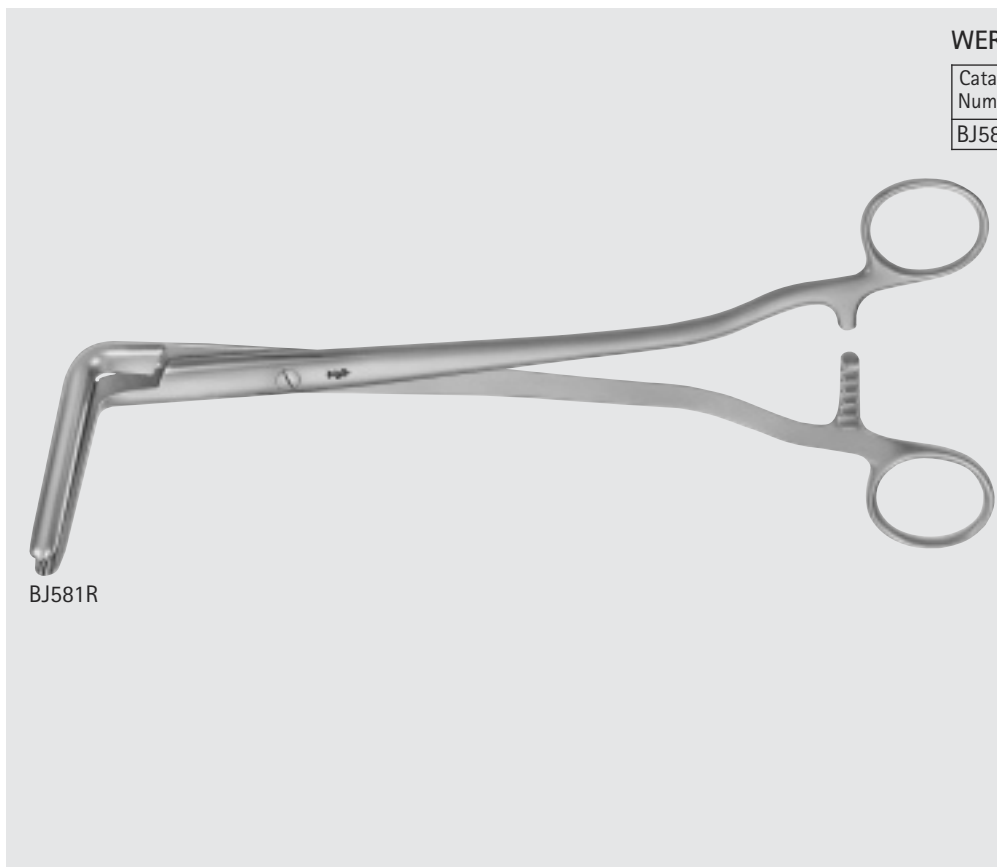

BJ581R

### WERTHEIM Atraumatic Clamp

Catalog Number	Jaw	Length (in.)
BJ581R	RT-ANG	10

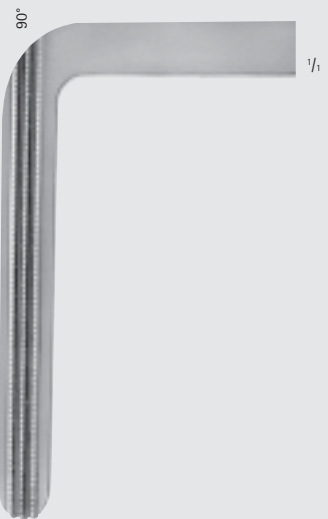



Uterine Clamp

Catalog Number	Jaw	Length (in.)
MB185R	STR	14
MB187R	STR	12
MB352R	STR	9 1/2
MB186R	SLT-CVD	14
MB188R	SLT-CVD	12
MB353R	SLT-CVD	9 1/2
MB183R	CVD	12
MB354R	CVD	9 1/2
MB184R	ANG	12
MB355R	ANG	9 1/2

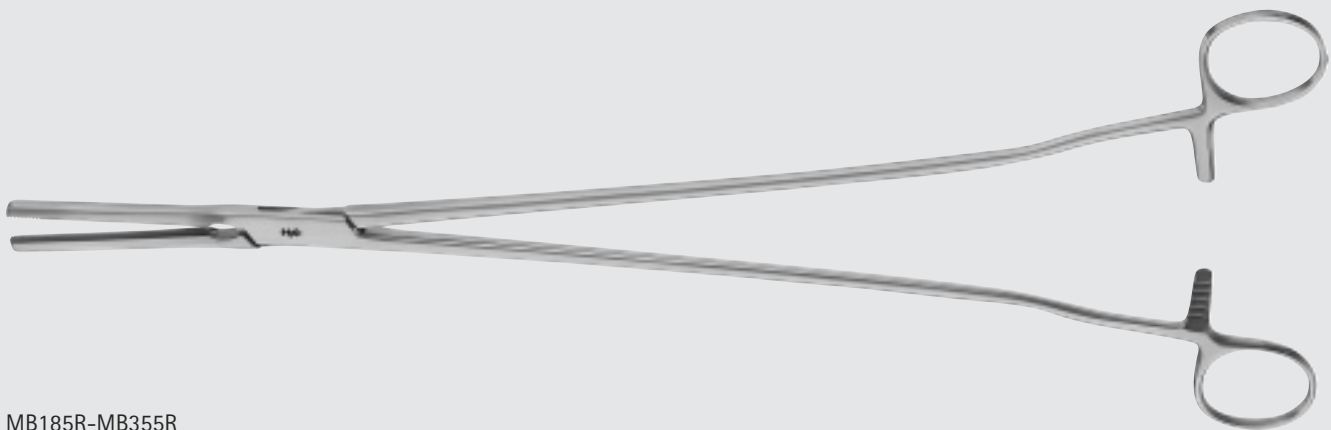

MB185R-MB355R



MB185R



MB187R



MB352R



MB186R



MB188R



MB353R



MB183R



MB354R



MB184R



MB355R



OB/GYN

INCHES

# Obstetrics/Gynecology

## Retractors

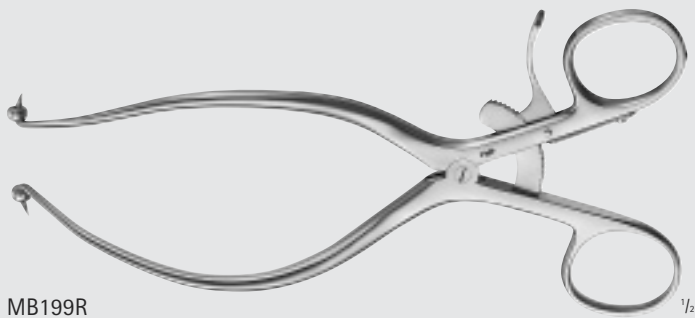

MB199R



GELPI Perineal Retractor

Catalog Number	Length (in.)
MB199R	7



BV996R

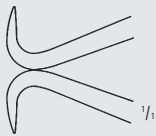

GELPI Vaginal Retractor

Catalog Number	Length (in.)
BV996R	5 1/4
BV997R	7

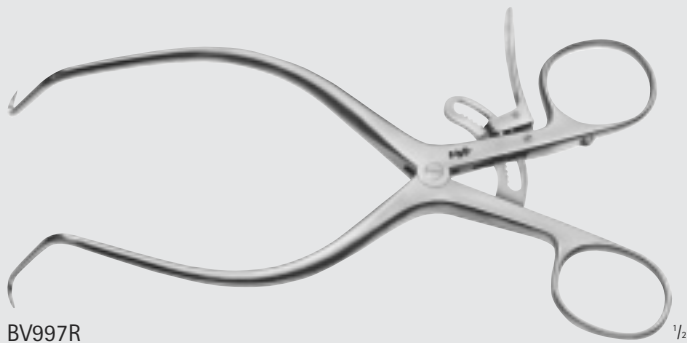

BV997R

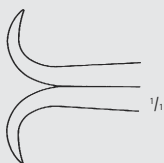

OB/GYN

GELPI Vaginal Retractor

Catalog Number	Length (in.)
MD651	7 1/4

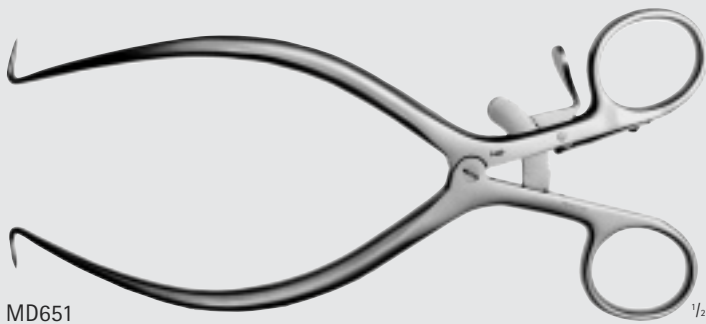

MD651

1/2

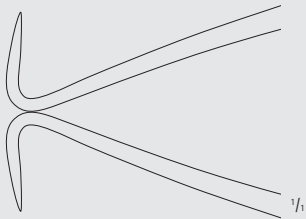

1/2

DE LEE Universal Retractor

Catalog Number	Length (in.)
MB068R	9 1/2



MB068R

1/2



# Obstetrics/Gynecology

## Retractors



US100-US100202



US100

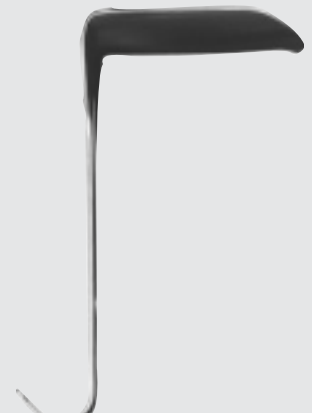

US100202

### O' SULLIVAN-O' CONNOR Retractor

Catalog Number	Item
US100	COMPLETE
US100201	SMALL BLADE
US100202	LARGE BLADE

US100 Includes:

- 1 Retractor US100
- 2 Blades US100201 and
- 1 Blade US100202

OB/GYN

MILLIMETERS

SEMM Abdominal Retractor

Catalog Number	Item	Blade Size (mm)
BV654R	COMPLETE	
BV653R	FRAME 255 x 220 MM	
BV655R	2 BLADES	46 x 64
BV656R	BLADE	53 x 54
BV657R	BLADE	82 x 97
BV658R	BLADE	98 x 51
BV659R	BLADE	107 x 36

BV654R Includes:  
 1 Frame BV653R  
 1 Blade of each BV656R, BV657R,  
 BV658R and BV659R  
 2 Blades BV655R

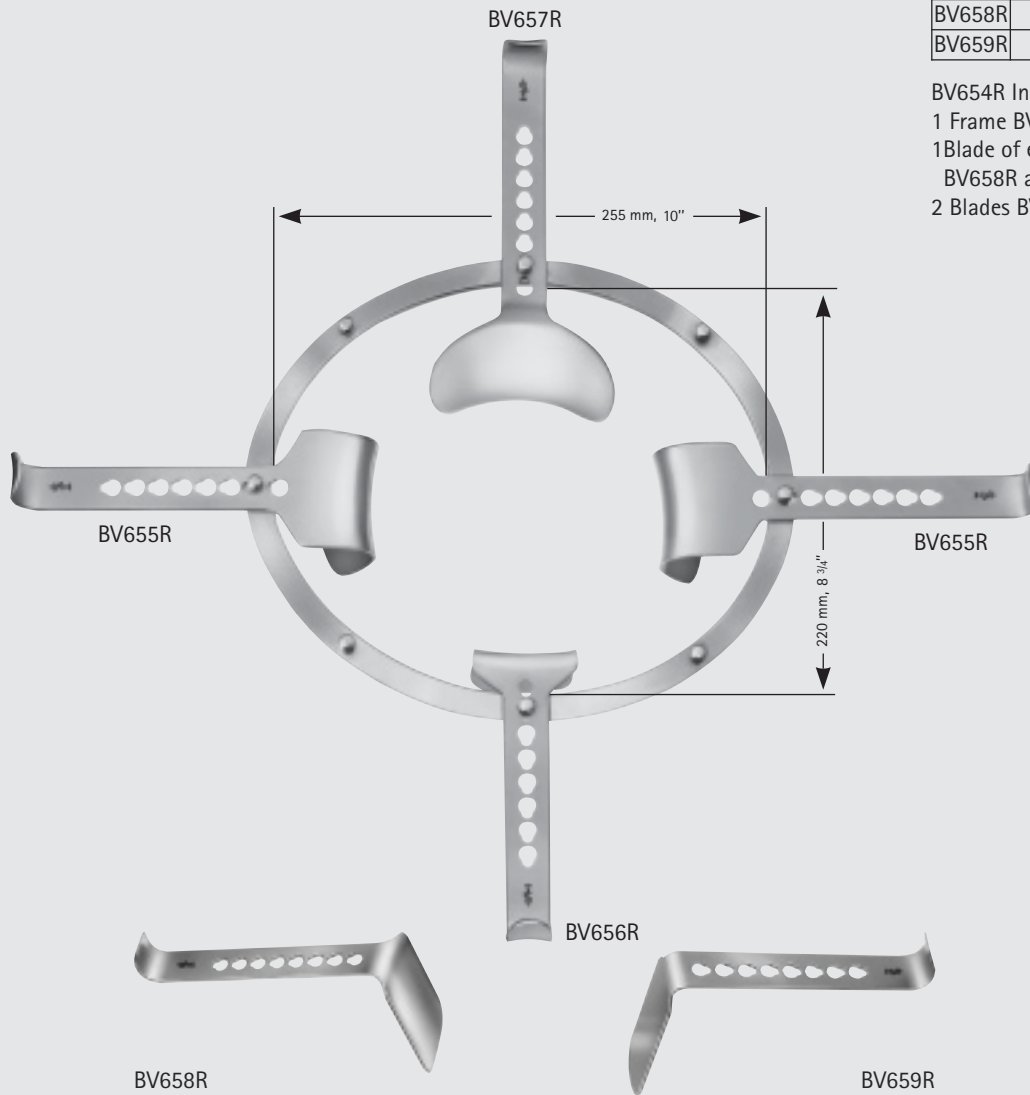

# Obstetrics/Gynecology

## Vaginal Specula



EL010C

### COLLIN Vaginal Speculum, Pediatric

Catalog Number	Blade Size (mm)
EL010C	53 x 10

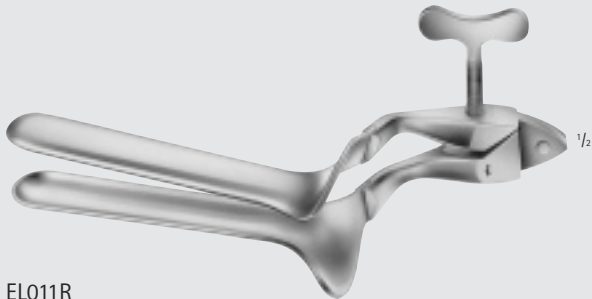

EL011R

### COLLIN Vaginal Specula

Catalog Number	Blade Size (mm)
EL011R	95/85 x 18

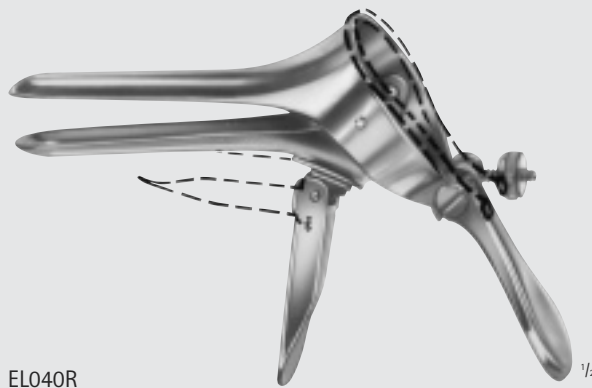

EL040R

### CUSCO Vaginal Specula

Catalog Number	Blade Size (mm)
EL040R	75 x 17

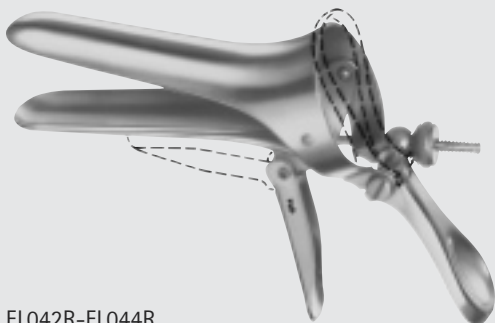

EL042R-EL044R

### CUSCO Vaginal Specula

Catalog Number	Blade Size (mm)
EL042R	80 x 32
EL043R	90 x 36
EL044R	110 x 37

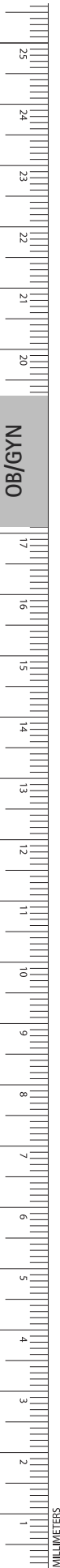

SEYFFERT Vaginal Specula

Catalog Number	Blade Size (mm)	Length (in.)
EL180R	100 x 17	9
EL181R	110 x 33	9

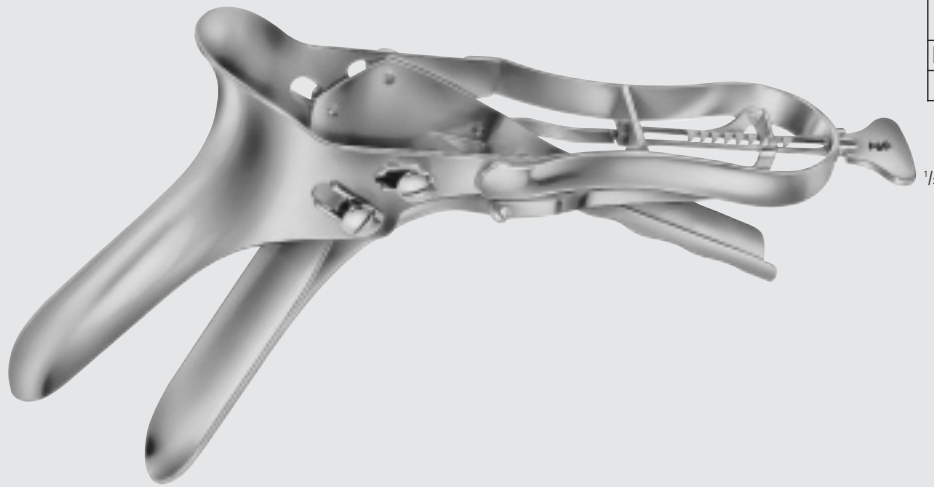

EL180R - EL181R

SEYFFERT Speculum, 1 Side Open

Catalog Number	Blade Size (mm)	Length (in.)
EL182R	110 x 33	9

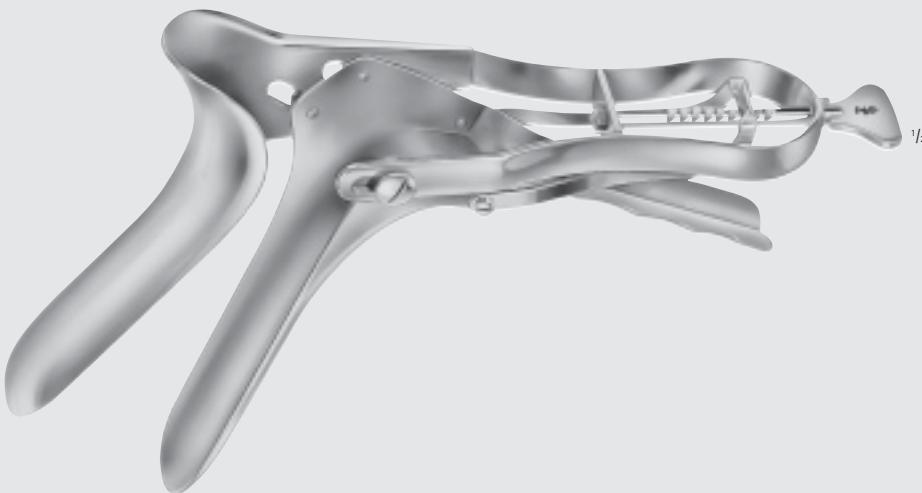

EL182R

SEMM Vaginal Specula

Catalog Number	Blade Size (mm)	Length (in.)
EL183R	90 x 14	7



EL183R



# Obstetrics/Gynecology

## Vaginal Specula



EL192R-EL193R

### PEDERSON Vaginal Speculum

Catalog Number	Blade Size (mm)
EL192R	100 x 22
EL193R	120 x 25



MB066R

### PEDERSON Vaginal Specula, Small

Catalog Number	Blade Size (mm)
MB066R	75 x 12.7





**PEDERSON Vaginal Speculum, Large**

Catalog Number	Blade Size (mm)
MB067R	120 x 25



MB067R

**GRAVE Vaginal Speculum, W/Side Opening**

Catalog Number	Blade Size (mm)
EL194R	75 x 20
EL195R	95 x 30
EL196R	105 x 33
MB841R	102 x 34



EL194R-EL196R

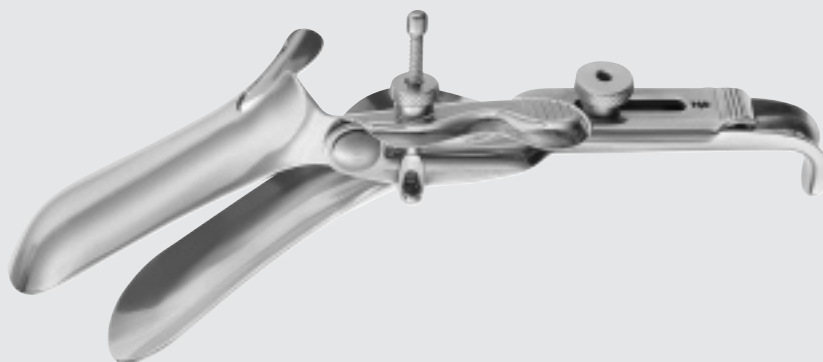

MB841R



INCHES

# Obstetrics/Gynecology

## Vaginal Specula



EL420R

### KRISTELLER Vaginal Specula

Catalog Number	Blade Size (mm)	Length (in.)
EL420R	70 x 15	6 3/4

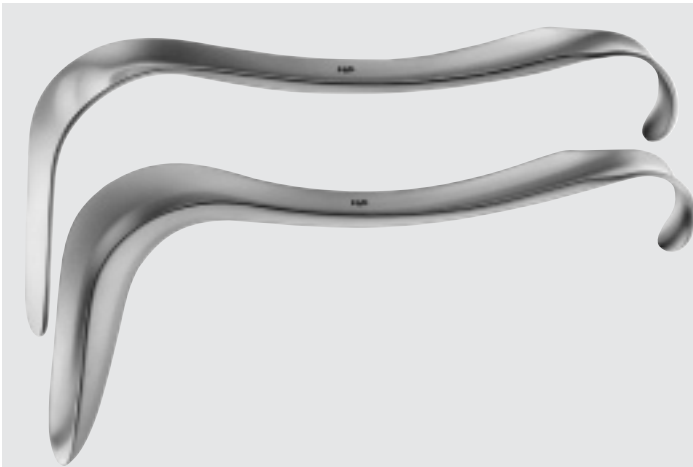

EL421R-EL423R

### KRISTELLER Vaginal Specula

Catalog Number	Blade Size (mm)	Length (in.)
EL421R	70 x 27	7
EL422R	75 x 30	7
EL423R	90 x 36	7



EL425R-EL428R

### KRISTELLER Vaginal Specula

Catalog Number	Blade Size (mm)	Length (in.)
EL425R	110 x 27	8 3/4
EL426R	110 x 20	8 3/4
EL427R	110 x 30	8 3/4
EL428R	110 x 36	8 3/4

OB/GYN

**KRISTELLER Vaginal Specula Lower Blades**

Catalog Number	Blade Size (mm)	Length (in.)
EL440R	70 x 15	7
EL441R	70 x 27	7
EL442R	75 x 30	7
EL443R	90 x 36	7 1/4



EL440R-EL443R



EL440R



EL441R



EL442R



EL443R

**KRISTELLER Vaginal Specula Upper Blades**

Catalog Number	Blade Size (mm)	Length (in.)
EL450R	75 x 10	7
EL451R	75 x 23	7
EL452R	80 x 25	7
EL453R	100 x 32	7 1/4



EL450R-EL453R



EL450R



EL451R



EL452R



EL453R



INCHES

# Obstetrics/Gynecology

## Vaginal Specula



EL444R-EL448R

### KRISTELLER Vaginal Specula Lower Blades

Catalog Number	Blade Size (mm)	Length (in.)
EL444R	110 x 18	8 1/2
EL445R	110 x 27	8 1/2
EL446R	110 x 20	8 3/4
EL447R	110 x 30	8 3/4
EL448R	110 x 36	9



EL444R



EL445R



EL446R



EL447R



EL448R

KRISTELLER Vaginal Specula Upper Blades

Catalog Number	Blade Size (mm)	Length (in.)
EL454R	115 x 14	8 1/2
EL455R	115 x 23	8 1/2
EL457R	115 x 26	8 3/4
EL458R	120 x 30	9



EL454R-EL458R

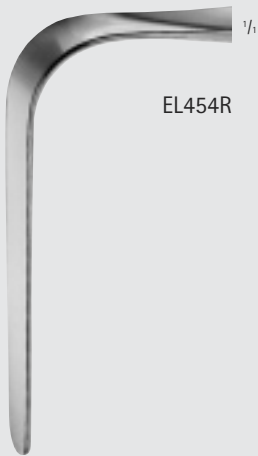

EL454R



EL455R



EL457R



EL458R



# Obstetrics/Gynecology

## Vaginal Specula



KALLMORGEN Vaginal Specula Set

Catalog Number	Blade Size (mm)	Length (in.)
EL480R	75 x 39	6 3/4



KALLMORGEN Vaginal Specula Set

Catalog Number	Blade Size (mm)	Length (in.)
EL481R	95 x 39	8

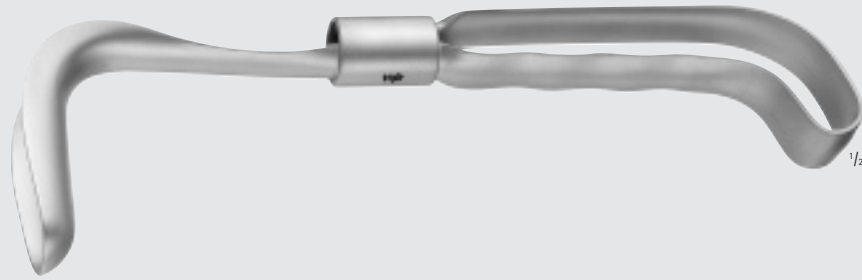

MB759R-MB761R

SIMS Vaginal Retractors

Catalog Number	Blade Size (mm)
MB759R	70 x 25
MB760R	76 x 32
MB761R	89 x 38

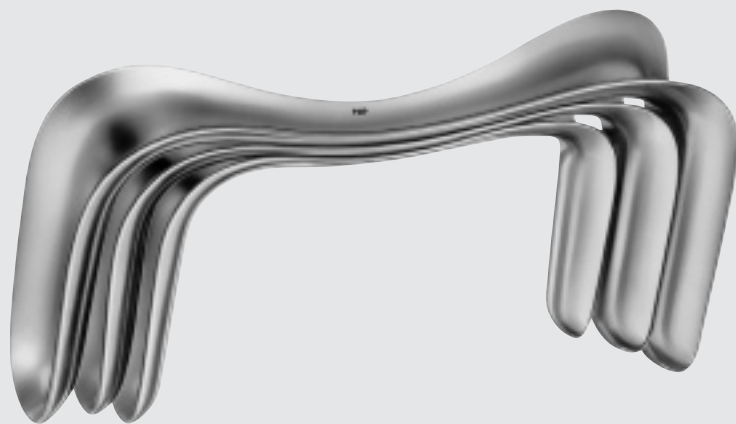

EL407R-EL409R



SIMS Vaginal Speculum

Catalog Number	Blade Size (mm)	Length (in.)
EL407R	70 x 26 / 75 x 30	5
EL408R	75 x 30 / 80 x 35	6
EL409R	80 x 36 / 90 x 40	7



INCHES

# Obstetrics/Gynecology

## Vaginal Specula



EL578R-EL579R



EL578R



EL579R

### JACKSON Vaginal Specula Lower Blade

Catalog Number	Blade	Blade Size (mm)	Length (in.)
EL578R	SLT-CONCAVE	89 x 38	7
EL579R	SLT-CONCAVE	102 x 38	7



EL581R



MB764R - MB765R

### EASTMAN Vaginal Retractor

Catalog Number	Blade Size (mm)	Length (in.)
EL581R	89 x 38	7
MB764R	75 x 40	7
MB765R	100 x 40	7





EL865R



MB762R-MB763R

**HEANEY Retractor**

Catalog Number	Blade Size (mm)	Length (in.)
EL865R	83 x 29	6 3/4
MB762R	45	6 3/4
MB763R	73	6 3/4

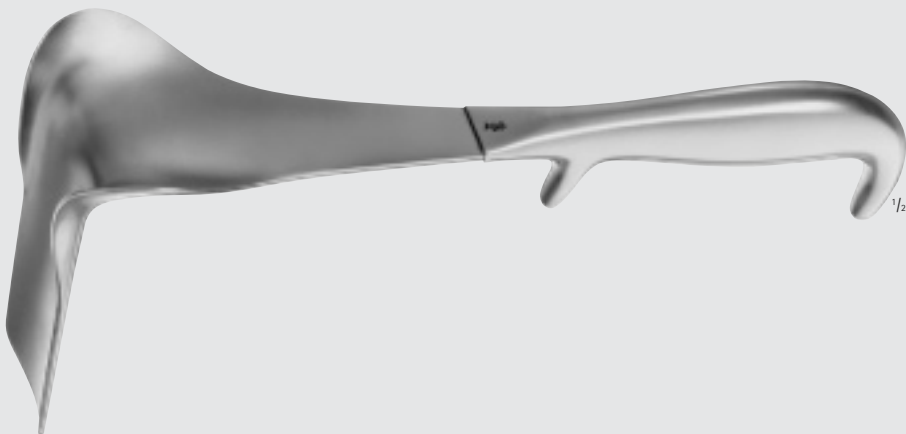

EL627R-EL629R



EL627R



EL628R



EL629R

**DOYEN Vaginal Specula**

Catalog Number	Blade Size (mm)	Length (in.)
EL627R	60 x 45	9 1/4
EL628R	90 x 45	9 1/4
EL629R	112 x 45	9 1/4



INCHES

# Obstetrics/Gynecology

## Vaginal Specula

### DOYEN Vaginal Specula

Catalog Number	Blade Size (mm)	Length (in.)
EL631R	60 x 35	9 1/2
EL632R	90 x 35	9 1/2
EL633R	120 x 35	9 1/2
EL634R	60 x 45	9 1/2
EL635R	90 x 45	9 1/2
EL636R	120 x 45	9 1/2
EL637R	60 x 60	9 1/2
EL638R	90 x 60	9 1/2
EL639R	120 x 60	9 1/2
EL642R	160 x 45	9 1/2
EL644R	160 x 60	9 1/2

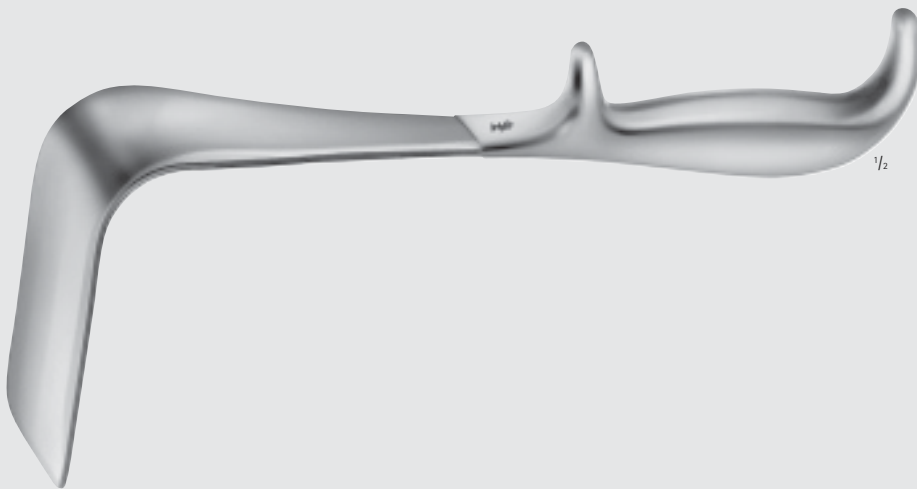

EL631R-EL644R

### BREISKY Vaginal Specula

Catalog Number	Blade Size (mm)	Length (in.)
EL693R	130 x 20	12 3/4
EL694R	130 x 25	12 3/4
EL695R	130 x 30	12 3/4
EL697R	130 x 35	12 3/4
EL698R	130 x 40	12 3/4



EL693R-EL698R



**BREISKY Vaginal Specula  
(continued)**

Catalog Number	Blade Size (mm)	Length (in.)
EL700R	160 x 40	14
EL702R	180 x 40	14
EL703R	100 x 20	12
EL704R	100 x 25	12
EL705R	100 x 30	12
EL707R	100 x 35	12
EL708R	100 x 40	12



EL700R-EL702R



EL703R-EL708R

**AUVARD Speculum, W/Detachable Weight**

Catalog Number	Blade Size (mm)	Length (in.)
EL736R	65 x 38-28	9

Weight:  
Speculum, only: 0.3 lbs.  
Weight, only: 1.7 lbs.

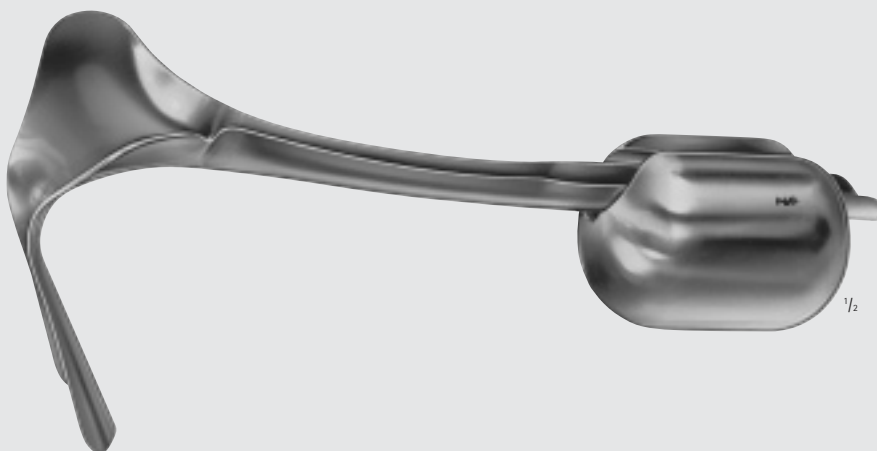

EL736R



# Obstetrics/Gynecology

## Vaginal Specula



OB/GYN

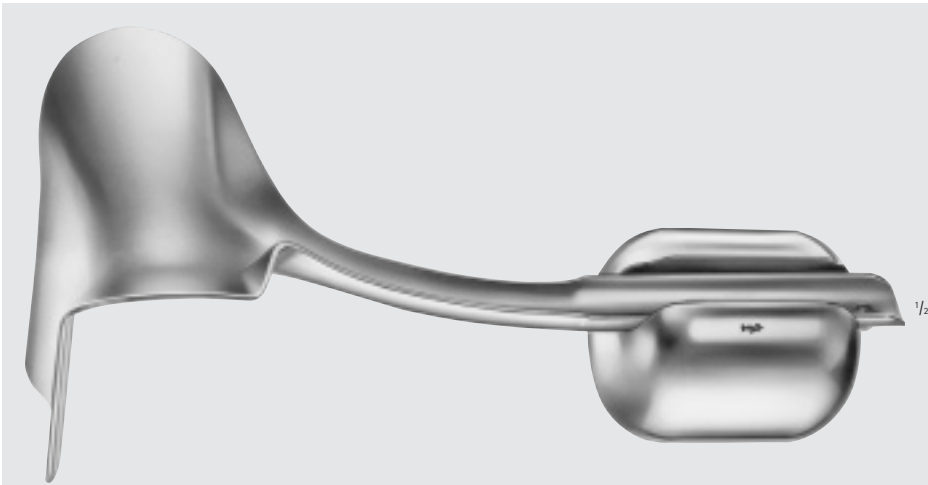

EL738R-EL739R

### AUVARD Speculum, W/Detachable Weight (continued)

Catalog Number	Blade Size (mm)	Length (in.)
EL738R	75 x 42-40	9
EL739R	105 x 43-40	9

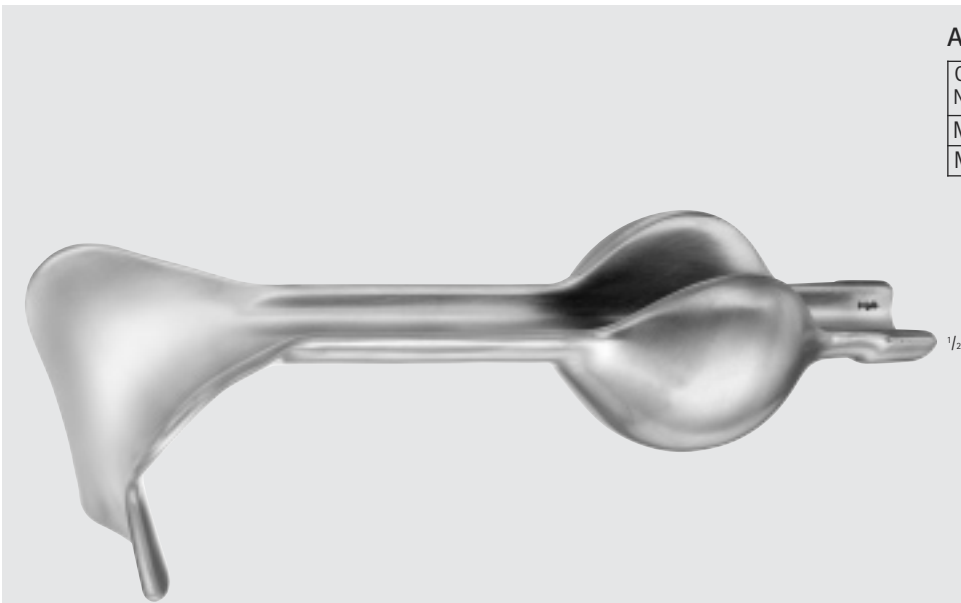

MD410-MD411

### AUVARD Speculum

Catalog Number	Blade Size (mm)	Length (in.)
MD410	85 x 38	10
MD411	102 x 38	10

DOYEN Lateral Speculum

Catalog Number	Blade Size (mm)	Length (in.)
EL859R	60 x 30	9
EL860R	80 x 30	10



EL859R



EL860R

SCHERBACK Vaginal Specula Set

Catalog Number	Item	Blade Size (mm)
EL740R	SET COMPLETE	
EL741R	BLADE	80 x 30
EL742R	BLADE	85 x 35
EL743R	BLADE	85 x 40
EL744R	BLADE	55 x 40
EL745R	BLADE	70 x 45
EL746R	HANDLE	
EL747R	WEIGHT	

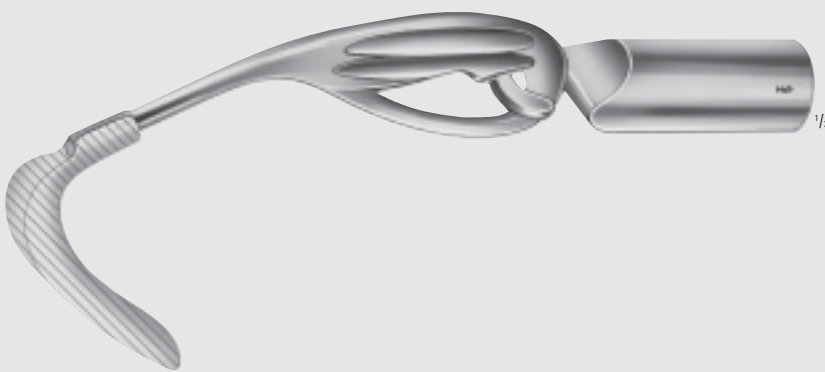

EL740R-EL747R

EL740R Includes:  
 1 Handle EL746R  
 1 Weight EL747R  
 4 Blades of each  
 EL741R - EL744R



EL741R



EL742R



EL743R

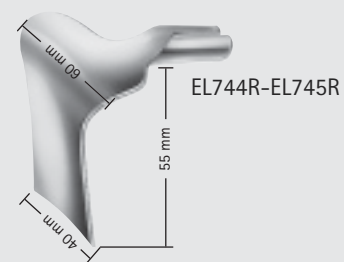

EL744R-EL745R



INCHES

# Obstetrics/Gynecology

## Vaginal Specula

### TUEBINGER Vaginal Retractor

Catalog Number	Blade Size (mm)	Length (in.)
EL868R	95 x 20	10 1/2

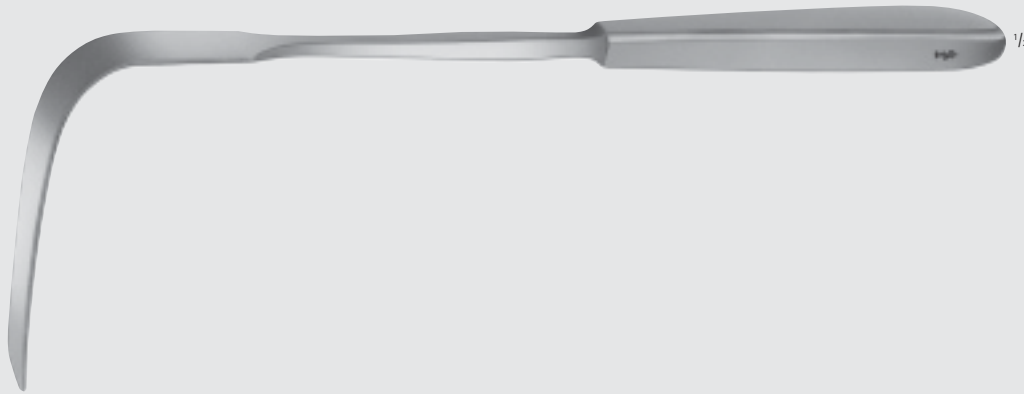

EL868R

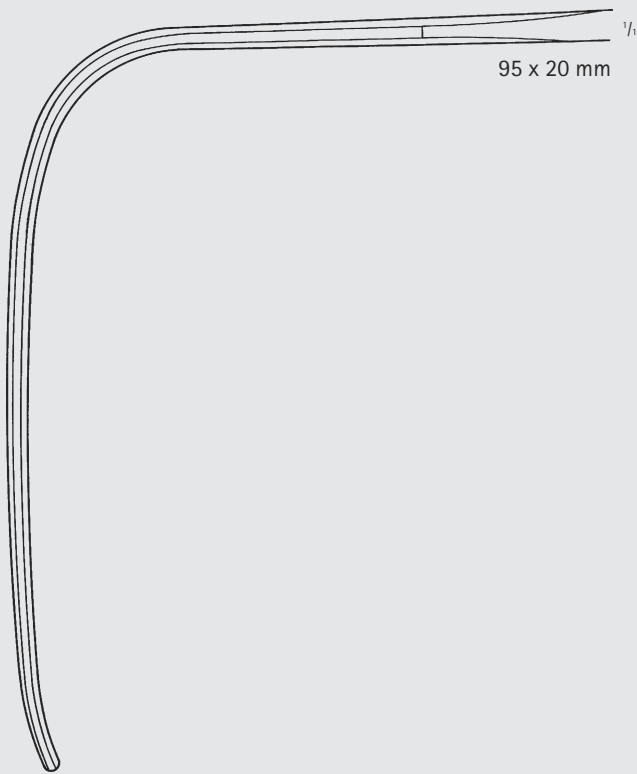

MARTIN Vaginal Retractor

Catalog Number	Blade Size (mm)	Length (in.)
EL870R	105 x 27	10

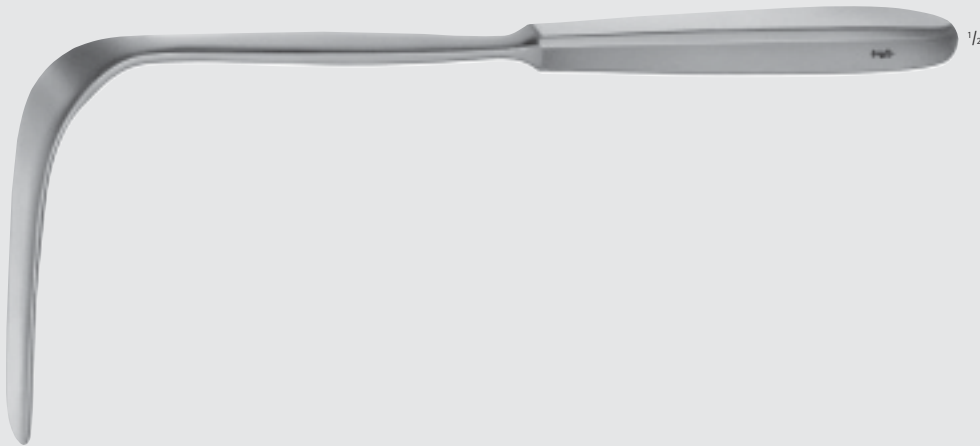

EL870R



OB/GYN

INCHES

# Obstetrics/Gynecology

## Vaginal Specula

### SIMON Vaginal Retractor

Catalog Number	Blade Size (mm)	Length (in.)
EL872R	115 x 22	10 3/4
EL873R	115 x 26	10 3/4



EL872R-EL873R



EL872R

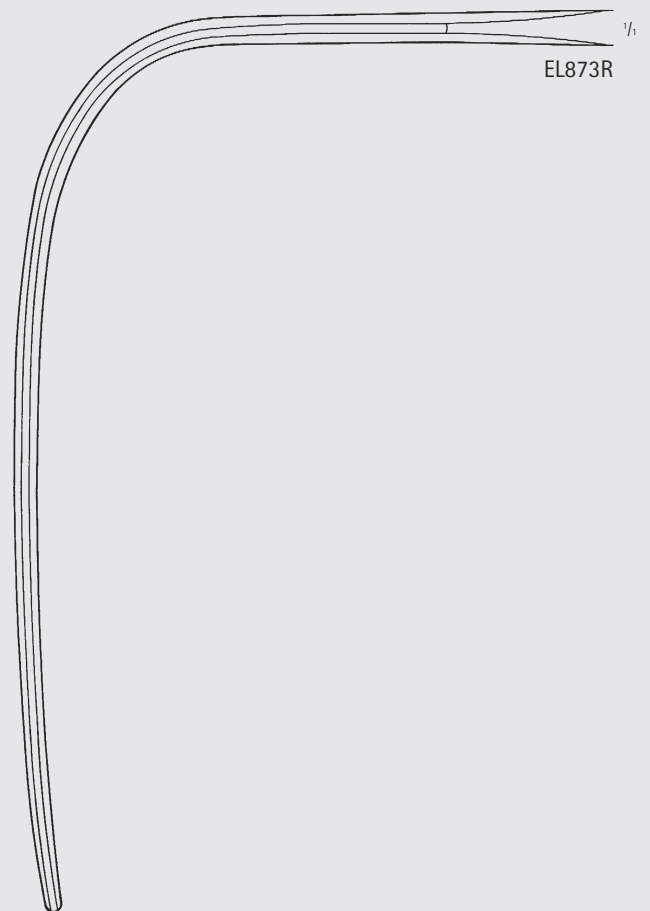

EL873R





KOGAN Endospeculum

Catalog Number	Length (in.)
EM710R	9 1/2

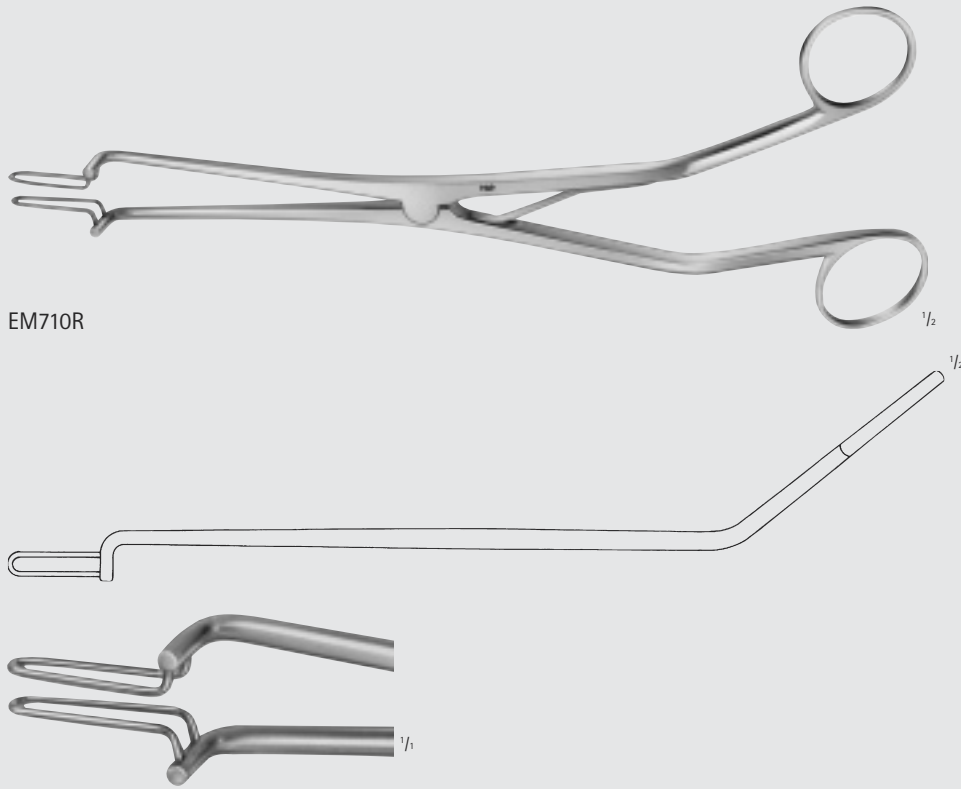

EM710R

KOGAN Cervix/Urethra Endospeculum, W/Scale, Ratcheted

Catalog Number	Length (in.)
EM711R	9 1/2

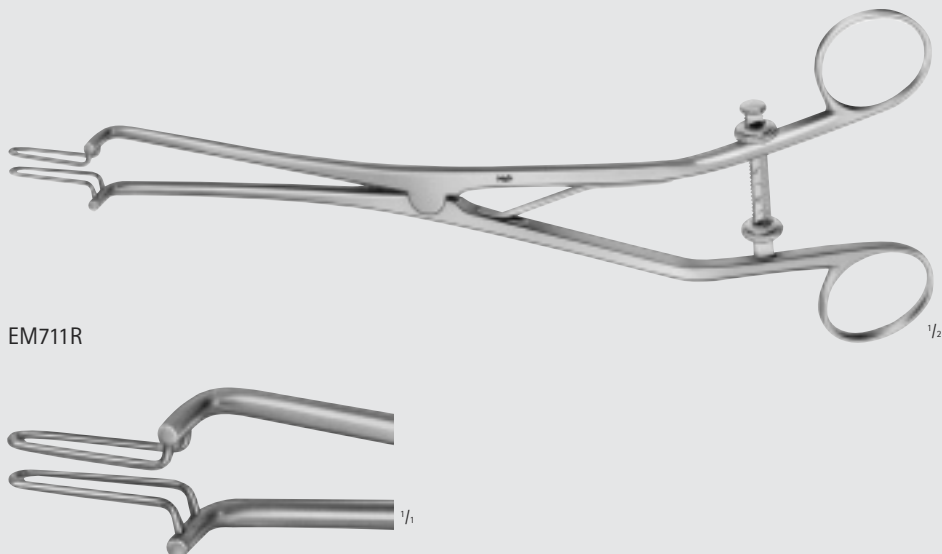

EM711R



INCHES

# Obstetrics/Gynecology

## Dilators & Probes



EM101R-EM147R

### HEGAR Dilator

Catalog Number	Tip Size (mm)	Length (in.)
EM101R	1	7 1/4
EM102R	2	7 1/4
EM103R	3	7 1/4
EM104R	4	7 1/4
EM105R	5	7 1/4
EM106R	6	7 1/4
EM107R	7	7 1/4
EM108R	8	7 1/4
EM109R	9	7 1/4
EM110R	10	7 1/4
EM111R	11	7 1/4
EM112R	12	7 1/4
EM113R	13	7 1/4
EM114R	14	7 1/4
EM115R	15	7 1/4
EM116R	16	7 1/4
EM117R	17	7 1/4
EM118R	18	7 1/4
EM119R	19	7 1/4
EM120R	20	7 1/4
EM121R	21	7 1/4
EM122R	22	7 1/4
EM123R	23	7 1/4
EM124R	24	7 1/4
EM125R	25	7 1/4
EM126R	26	7 1/4
EM131R	1.5	7 1/4
EM132R	2.5	7 1/4
EM133R	3.5	7 1/4
EM134R	4.5	7 1/4
EM135R	5.5	7 1/4
EM136R	6.5	7 1/4
EM137R	7.5	7 1/4
EM138R	8.5	7 1/4
EM139R	9.5	7 1/4
EM140R	10.5	7 1/4
EM141R	11.5	7 1/4
EM142R	12.5	7 1/4
EM143R	13.5	7 1/4
EM144R	14.5	7 1/4
EM145R	15.5	7 1/4
EM146R	16.5	7 1/4
EM147R	17.5	7 1/4



**HEGAR Dilator Set, W/14 Dilators, 4-17mm**

Catalog Number
EM193R

EM193R Includes:  
 EM097R ? Rack for Dilators 4-12 mm  
 EM098R ? Rack for Dilators 13-17 mm  
 JG161R ? Metal Case: 200 x 100 x 35 mm

Includes Dilators:  
 EM104R - EM117R



EM193R

**HEGAR Uterine Dilator**

Catalog Number	Tip Size (mm)	Length (in.)
EM231R	1/2	7 3/4
EM232R	3/4	7 3/4
EM233R	5/6	7 3/4
EM234R	7/8	7 3/4
EM235R	9/10	7 3/4
EM236R	11/12	7 3/4
EM237R	13/14	7 3/4
EM238R	15/16	7 3/4
EM239R	17/18	7 3/4



EM231R-EM239R



OB/GYN

INCHES

# Obstetrics/Gynecology

## Dilators & Probes

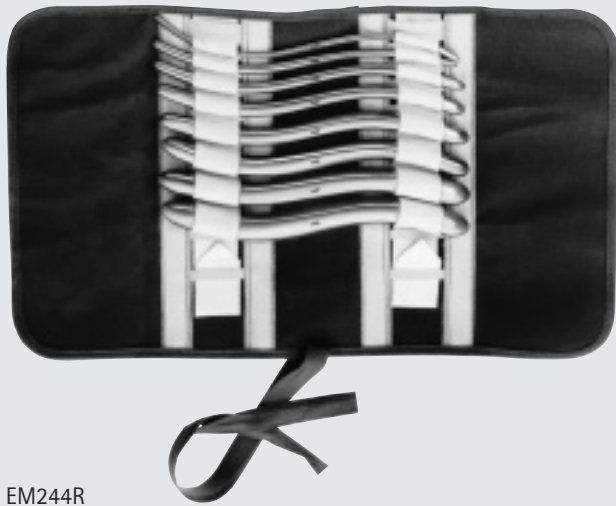

EM244R

### HEGAR Dilator Set, W/ Dilators, (EM232R-EM239R)

Catalog Number
EM244R

Includes Canvas Roll, EM245R

### PRATT Uterine Dilator

Catalog Number	Tip Size (FR)	Length (in.)
EM270R	COMPLETE SET	
EM271R	13/15	11 1/2
EM272R	17/19	11 1/2
EM273R	21/23	11 1/2
EM274R	25/27	11 1/2
EM275R	29/31	11 1/2
EM276R	33/35	11 1/2
EM277R	37/39	11 1/2
EM278R	41/43	11 1/2



EM270R-EM278R

### HANK Dilator

Catalog Number	Tip Size (FR)	Length (in.)
MD579R	9/10	10
MD593R	COMPLETE SET	10
MD594	11/12	10
MD595	13/14	10
MD596	15/16	10
MD597	17/18	10
MD598	19/20	10



MD579R-MD598

OB/GYN

HANK Dilator, American Scale

Catalog Number	Tip Size (FR)	Length (in.)
MD064R	9/10	10 3/4
MD065R	11/12	10 3/4
MD066R	13/14	10 3/4
MD067R	15/16	10 3/4
MD068R	17/18	10 3/4
MD069R	19/20	10 3/4
MD070R	COMPLETE SET	10 3/4



MD064R-MD070R

SIMS Uterine Probe, Graduated

Catalog Number	Tip	Tip Size (mm)	Blade	Length (in.)
E0010R	RGD	4	CVD	13
E0012R	MALL	4	CVD	13

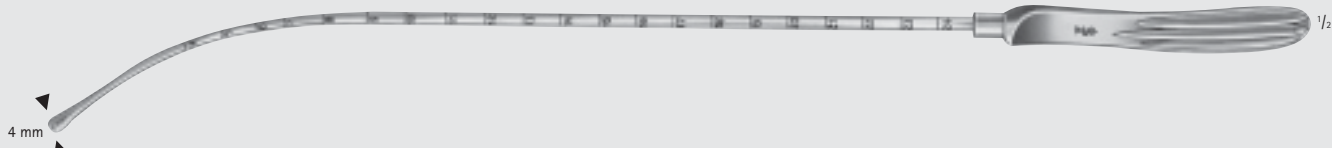

E0010R-E0012R

MARTIN Uterine Probe, Graduated

Catalog Number	Tip Size (mm)	Blade	Length (in.)
E0015R	3	CVD	12



E0015R



# Obstetrics/Gynecology

## Dilators & Probes



OB/GYN

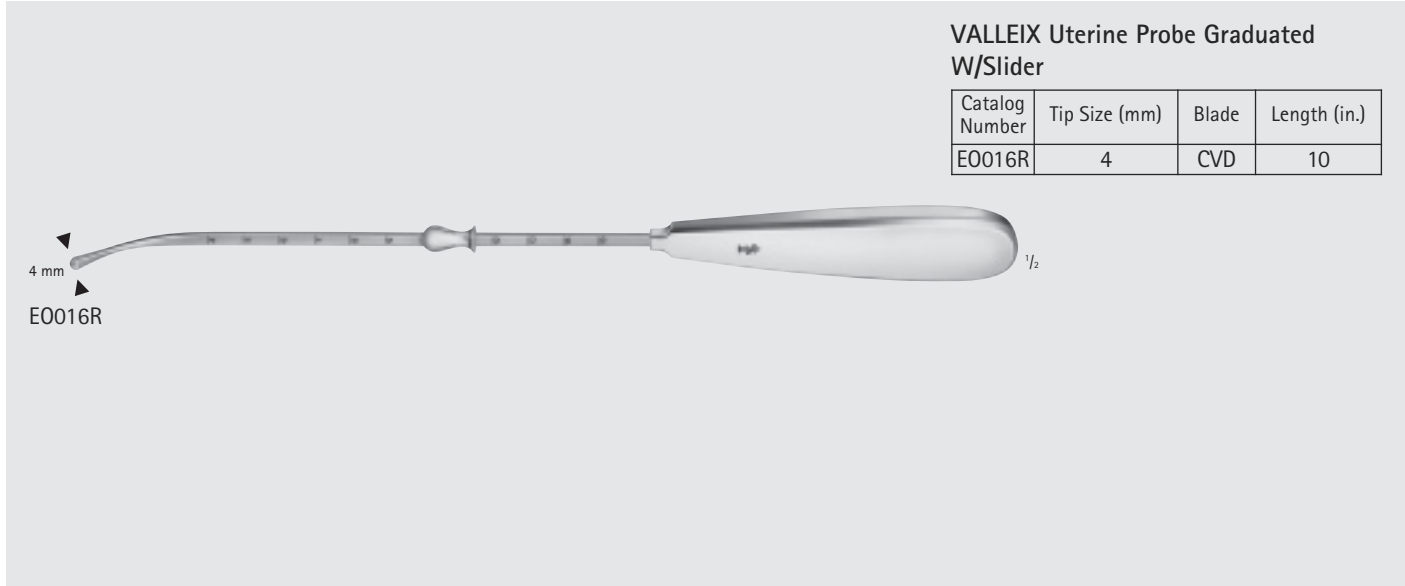

**VALLEIX Uterine Probe Graduated W/Slider**

Catalog Number	Tip Size (mm)	Blade	Length (in.)
EO016R	4	CVD	10

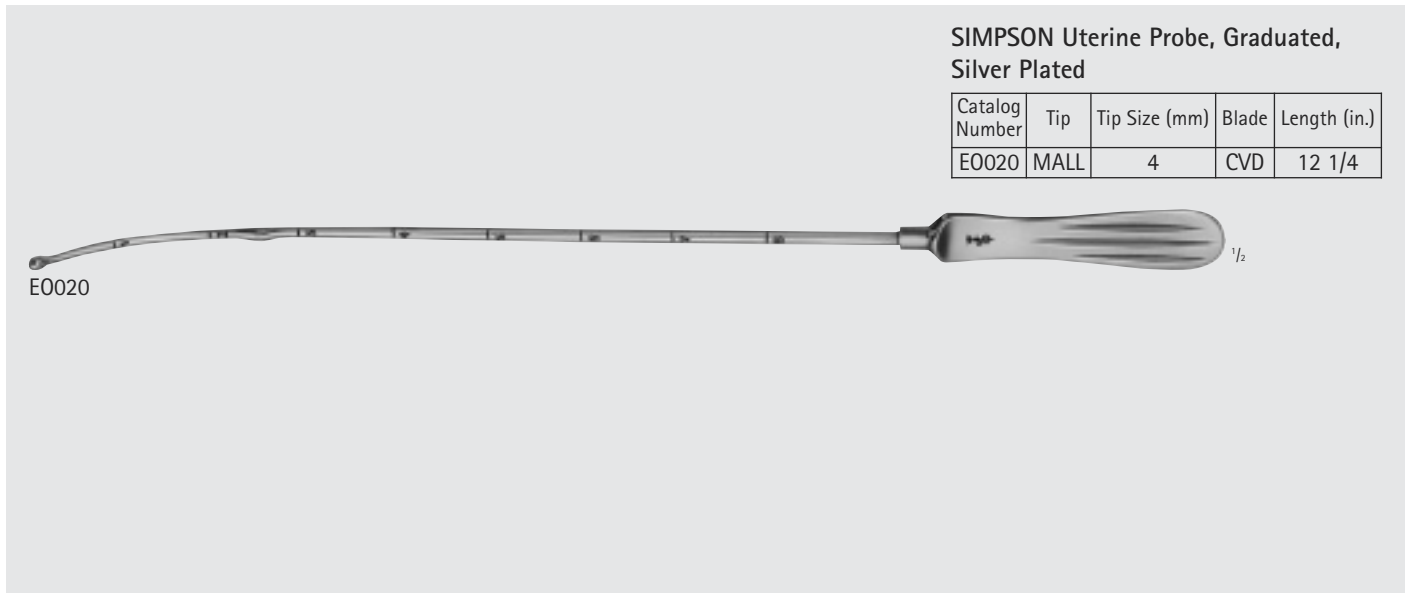

**SIMPSON Uterine Probe, Graduated, Silver Plated**

Catalog Number	Tip	Tip Size (mm)	Blade	Length (in.)
EO020	MALL	4	CVD	12 1/4

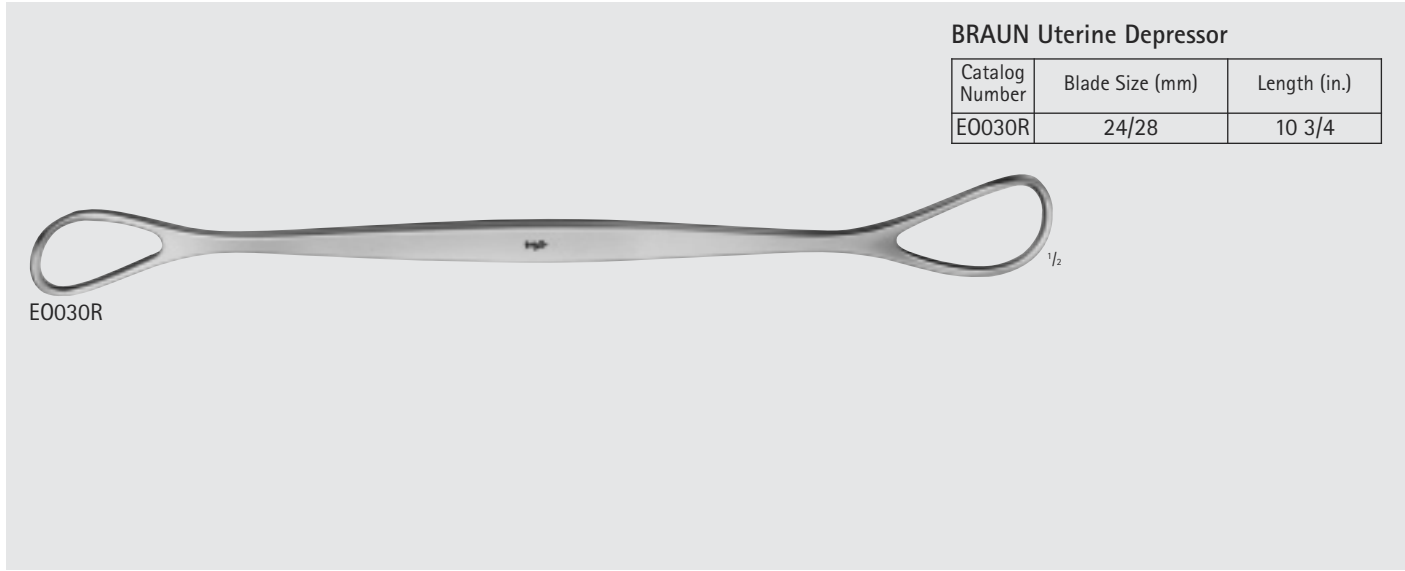

**BRAUN Uterine Depressor**

Catalog Number	Blade Size (mm)	Length (in.)
EO030R	24/28	10 3/4



ASCH Uterine Secretion Scoop,  
Malleable

Catalog Number	Length (in.)
ER005R	8

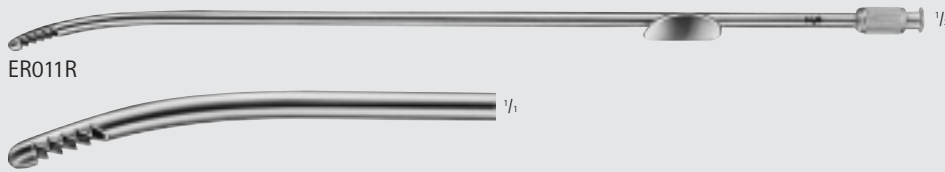

NOVAK-SCHOECKAERT Endometrial  
Biopsy Curette

Catalog Number	Length (in.)
ER011R	9 1/2

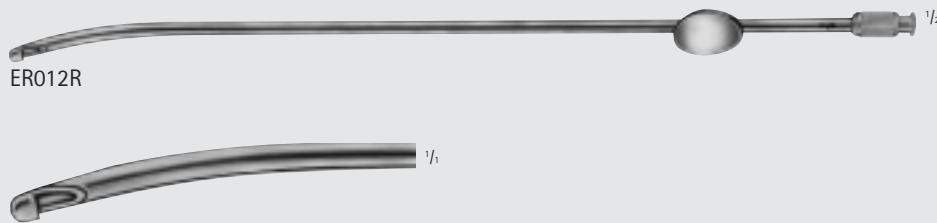

RANDALL Endometrial Curette

Catalog Number	Length (in.)
ER012R	9 1/2



BERLIN Endometrial Biopsy Curette

Catalog Number	Tip Size (mm)	Length (in.)
ER015R	3.5	10 3/4



OB/GYN

# Obstetrics/Gynecology

## Curettes



ER219R-ER330R

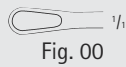

Fig. 00



Fig. 0



1



2



3



4



5



6

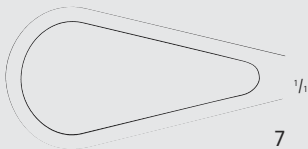

7

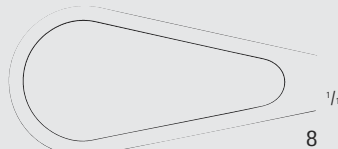

8



9

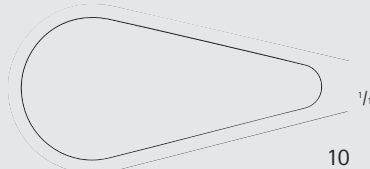

10



ER611R-ER612R

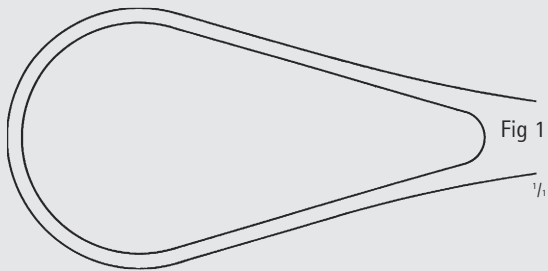

Fig 1

ER611R

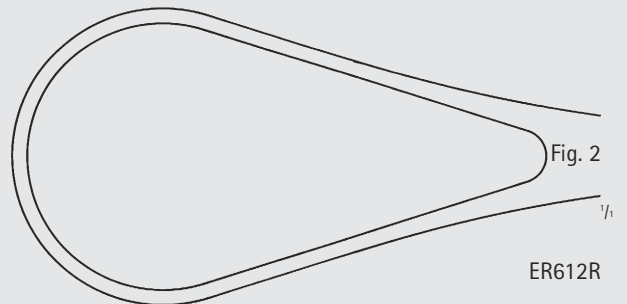

Fig. 2

ER612R

### RECAMIER Uterine Curette

Catalog number	Size	Tip Size (mm)	Tip	Length (in.)
ER219R	#00	4.5	SHARP	12
ER220R	#0	7.5	SHARP	12
ER221R	#1	8.5	SHARP	12
ER222R	#2	10.5	SHARP	12
ER223R	#3	12.0	SHARP	12
ER224R	#4	14.0	SHARP	12
ER225R	#5	15.0	SHARP	12
ER226R	#6	16.5	SHARP	12
ER227R	#7	18.0	SHARP	12
ER228R	#8	19.5	SHARP	12
ER229R	#9	21.5	SHARP	12
ER230R	#10	23.5	SHARP	12
ER241R	#1	8.5	S/MALL	12
ER242R	#2	10.5	S/MALL	12
ER243R	#3	12.0	S/MALL	12
ER244R	#4	14.0	S/MALL	12
ER245R	#5	15.0	S/MALL	12
ER246R	#6	16.5	S/MALL	12
ER247R	#7	18.0	S/MALL	12
ER248R	#8	19.5	S/MALL	12
ER320R	#0	7.5	BLUNT	12
ER321R	#1	8.5	BLUNT	12
ER322R	#2	10.5	BLUNT	12
ER323R	#3	12.0	BLUNT	12
ER324R	#4	14.0	BLUNT	12
ER325R	#5	15.0	BLUNT	12
ER326R	#6	16.5	BLUNT	12
ER327R	#7	18.0	BLUNT	12
ER328R	#8	19.5	BLUNT	12
ER329R	#9	21.5	BLUNT	12
ER330R	#10	23.5	BLUNT	12
ER611R	#1	34.5	BLUNT	14 3/8
ER612R	#2	39.5	BLUNT	14 3/8

OB/GYN



SIMS Uterine Curette

Catalog Number	Size	Tip Size (mm)	Tip	Length (in.)
ER401R	#1	7.5	SHARP	10
ER402R	#2	8.5	SHARP	10
ER403R	#3	10.5	SHARP	10
ER404R	#4	12.0	SHARP	10
ER405R	#5	14.0	SHARP	10
ER406R	#6	15.0	SHARP	10
ER411R	#1	7.5	S/MALL	10
ER412R	#2	8.5	S/MALL	10
ER413R	#3	10.5	S/MALL	10
ER414R	#4	12.0	S/MALL	10
ER415R	#5	14.0	S/MALL	10
ER416R	#6	15.0	S/MALL	10
ER421R	#1	7.5	BLUNT	10
ER422R	#2	8.5	BLUNT	10
ER423R	#3	10.5	BLUNT	10
ER424R	#4	12.0	BLUNT	10
ER425R	#5	14.0	BLUNT	10
ER426R	#6	15.0	BLUNT	10



ER401R-ER426R



Fig. 1



Fig. 2



3



4



5

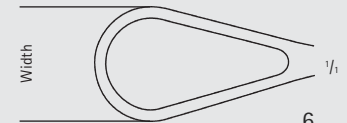

6



# Obstetrics/Gynecology

## Curettes

### BUMM Uterine Curette

Catalog Number	Size	Tip Size (mm)	Tip	Length (in.)
ER520R	#0	16.0	B/MALL	11 1/2
ER521R	#1	18.0	B/MALL	11 1/2
ER522R	#2	19.5	B/MALL	11 1/2
ER523R	#3	21.5	B/MALL	11 1/2
ER524R	#4	23.5	B/MALL	11 1/2
ER525R	#5	26.0	B/MALL	11 1/2
ER526R	#6	28.5	B/MALL	11 1/2



ER520R-ER526R



Fig. 0

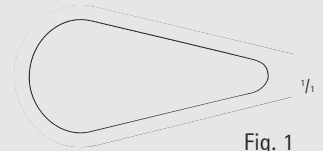
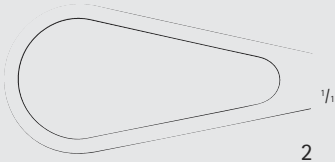
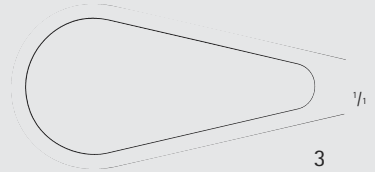

Fig. 1



2



3

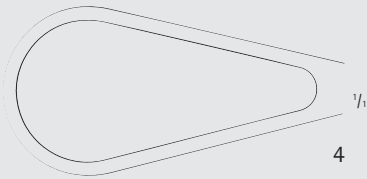

4

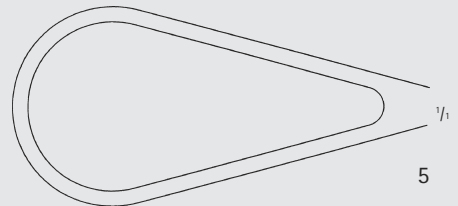

5

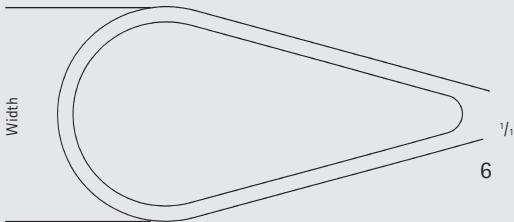

6

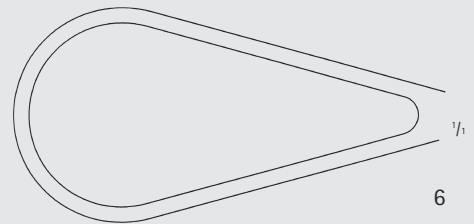

6

OB/GYN

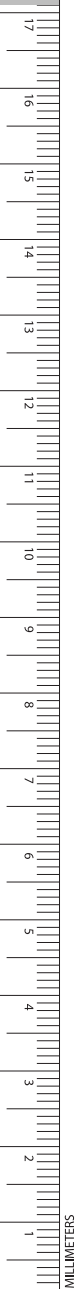

**THOMAS Uterine Curette**

Catalog Number	Size	Tip Size (mm)	Length (in.)
ER211R	#1	8.5	11
ER212R	#2	10.5	11
ER213R	#3	12.0	11
ER214R	#4	14.0	11
ER215R	#5	15.0	11
ER216R	#6	16.5	11



ER211R-ER216R

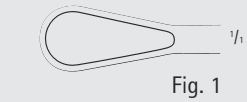
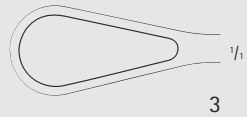
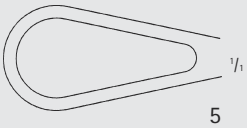

Fig. 1



3



5



Fig. 2



4



6

**KELLY-GRAY Uterine Curette**

Catalog Number	Size	Length (in.)
MB375R	1	9 1/2
MB376R	2	9 1/2
MB377R	3	9 1/2
MB378R	4	9 1/2



MB375R-MB378R



MB375R



MB377R



MB376R



MB378R



OB/GYN

INCHES

# Obstetrics/Gynecology

## Curettes



### HEANEY Uterine Curette

Catalog Number	Tip	Length (in.)
ER025R	TOOTHED	9 5/8



ER025R



### COLLIN Uterine Curette

Catalog Number	Tip	Length (in.)
ER580R	TOOTHED	12



ER580R



### BLAKE Uterine Curette

Catalog Number	Tip	Length (in.)
ER585R	S/B	10 3/4



ER585R

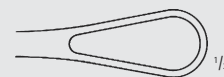

**BUMM Uterine Curette**

Catalog Number	Size	Tip Size (mm)	Tip	Length (in.)
ER621R	#1	23.5	S/MALL	12 3/8
ER623R	#3	28.5	S/MALL	12 3/8
ER626R	#1	23.5	B/MALL	12 3/8
ER627R	#2	26.0	B/MALL	12 3/8
ER628R	#3	28.5	B/MALL	12 3/8



ER621R-ER628R

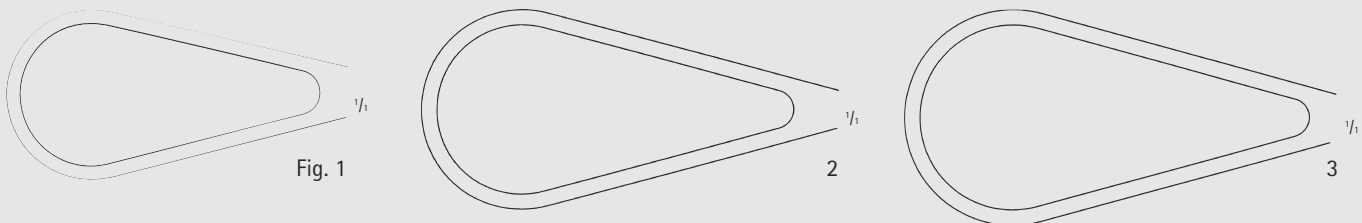

**KEVORKIAN-YOUNGE Biopsy Curette**

Catalog Number	Tip	Length (in.)
MD472	SLT-CVD	13

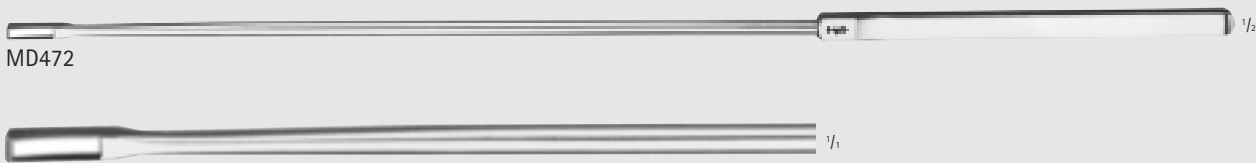

MD472

**WALLICH Placenta/Ovum Scoop**

Catalog Number	Tip	Length (in.)
ER602R	CVD	16 3/4



ER602R

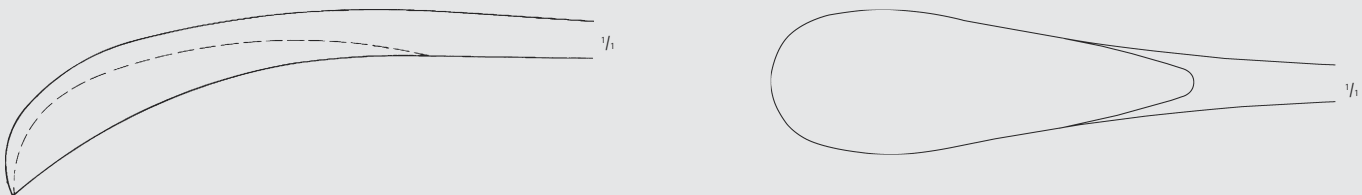

OB/GYN

INCHES

# Obstetrics/Gynecology

## Accessories



### Guide Sheath, IOWA Trumpet

Catalog number	Tip Size (mm)	Item	Length (in.)
ET096R	-	-	7
SR580R	1 x 185	INJECTION NEEDLE, LUER-LOCK HUB	

### Uterine Cannula W/2 Cones

Catalog Number	Length (in.)
ER876	13

#### Cones:

- 1 ER876201 (small)
- 1 ER876202 (large)

