



General Surgery

Scissors	2-58
Needle Holders & Cases	59-82
Ligature Needles	83-86
Forceps & Clamps	87-185
Skin Hooks	186-188
Retractors	189-273
Universal Ring Retractor System	250-260
Rectal Specula Instruments	274-280
Probes, Dilators & Scoops	281-287
Scalpel Blades & Handles	288-294
Amputation & Autopsy Instruments	295-297
Suction Instruments	298-307
Vessel Instruments	308-310
Rulers, Calipers & Accessories	311-312
Tongue Forceps	313-314
Metal Bowls & Cups	315

General Surgery

Scissors



BC374R-BC474R

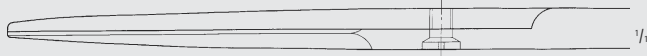

BC374R

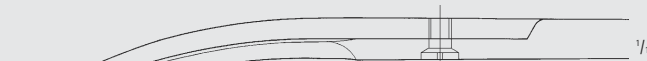

BC474R

DEAVER Suture Scissors

Catalog Number	Tip	Blade	Length (in.)
BC374R	S/B	STR	5 3/4
BC464R	B/B	CVD	5 3/4
BC474R	S/B	CVD	5 3/4



BC464R

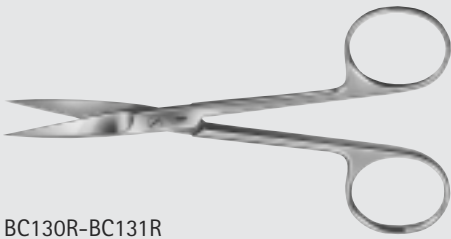

BC130R-BC131R

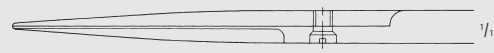

BC130R

Suture Scissors

Catalog Number	Tip	Blade	Length (in.)
BC130R	S/S	STR	4 3/4
BC131R	S/S	CVD	4 3/4
BC341R	S/S	STR	4 1/2
BC343R	S/S	STR	5 1/8
BC344R	S/S	STR	5 3/4
BC345R	S/S	STR	6
BC346R	S/S	STR	6 1/2

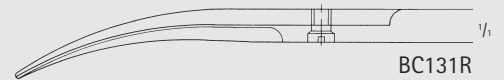

BC131R



BC341R-BC346R

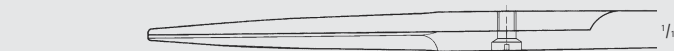

BC341R

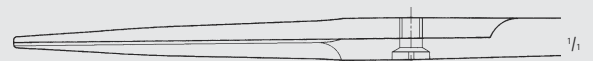

BC343R

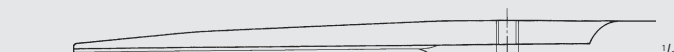

BC344R

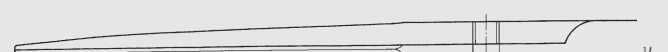

BC345R

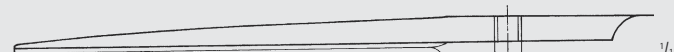

BC346R



BC441R-BC445R

Suture Scissors

Catalog Number	Tip	Blade	Length (in.)
BC441R	S/S	CVD	4 1/2
BC443R	S/S	CVD	5 1/8
BC444R	S/S	CVD	5 3/4
BC445R	S/S	CVD	6



BC441R



BC443R



BC444R

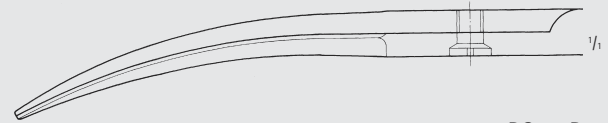

BC445R

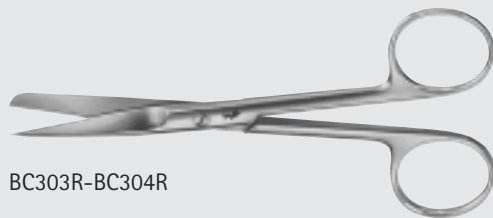

BC303R-BC304R

Suture Scissors

Catalog Number	Tip	Blade	Length (in.)
BC303R	S/B	DEL, STR	5 1/8
BC304R	S/B	DEL, STR	5 3/4

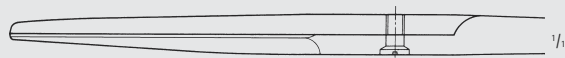

BC303R

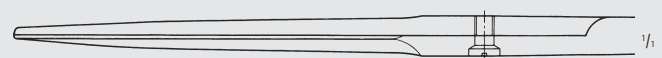

BC304R



BC496R

Scissors

Catalog Number	Tip	Blade	Length (in.)
BC496R	S/B	STR/1SERR	5 1/8

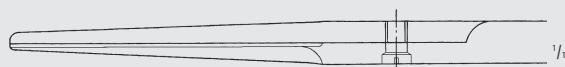

General Surgery

Scissors



BC320R-BC330R

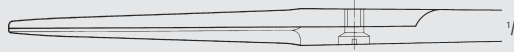

BC320R

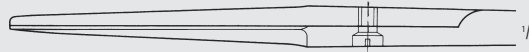

BC321R

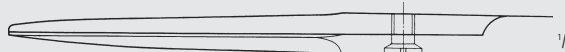

BC323R

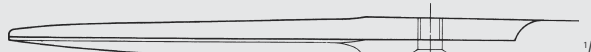

BC324R

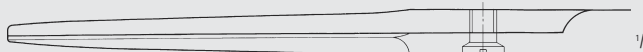

BC325R

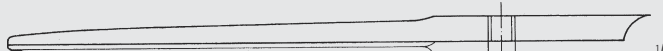

BC326R

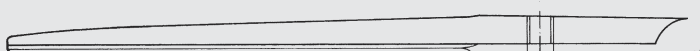

BC327R

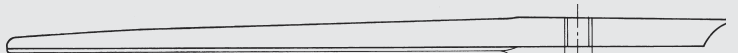

BC328R

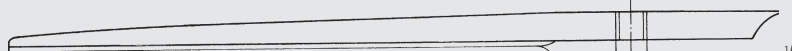

BC330R

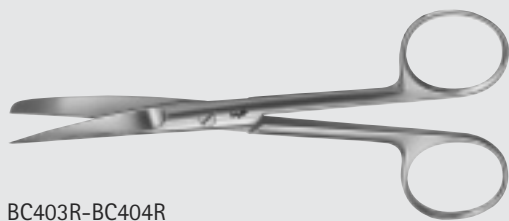

BC403R-BC404R

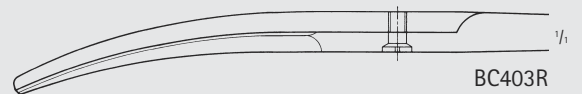

BC403R

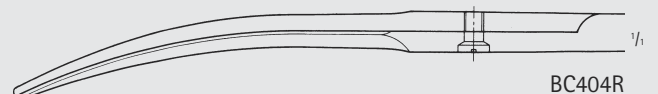

BC404R

Suture Scissors

Catalog Number	Tip	Blade	Length (in.)
BC320R	S/B	STR	4 1/8
BC321R	S/B	STR	4 1/2
BC323R	S/B	STR	5 1/8
BC324R	S/B	STR	5 3/4
BC325R	S/B	STR	6
BC326R	S/B	STR	6 1/2
BC327R	S/B	STR	7
BC328R	S/B	STR	7 1/4
BC330R	S/B	STR	8
BC403R	S/B	CVD	5 1/8
BC404R	S/B	CVD	5 3/4

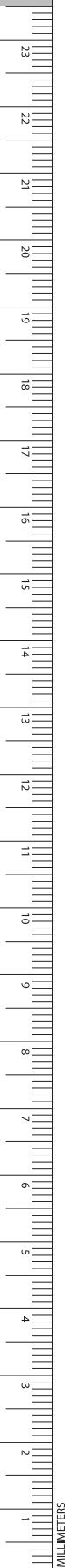

Suture Scissors

Catalog Number	Tip	Blade	Length (in.)
BC421R	S/B	CVD	4 1/2
BC423R	S/B	CVD	5 1/8
BC424R	S/B	CVD	5 3/4
BC425R	S/B	CVD	6
BC426R	S/B	CVD	6 1/2
BC428R	S/B	CVD	7 1/4



BC421R-BC428R



BC421R

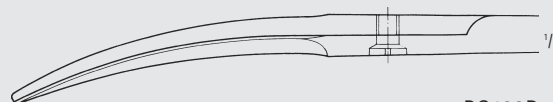

BC423R

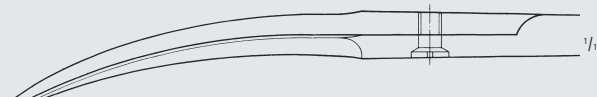

BC424R

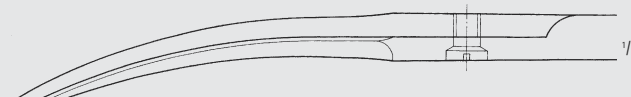

BC425R

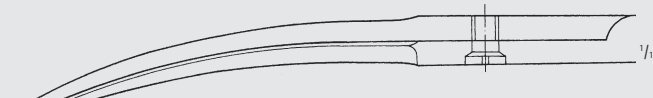

BC426R

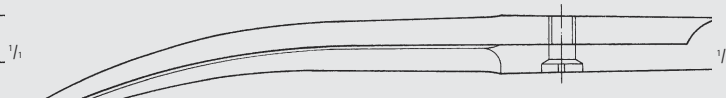

BC428R

COOPER Suture Scissors

Catalog Number	Tip	Blade	Length (in.)
BC313R	B/B	STR	5 1/8
BC314R	B/B	STR	5 3/4
BC315R	B/B	STR	6
BC316R	B/B	STR	6 1/2
BC317R	B/B	STR	7



BC313R-BC317R

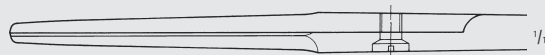

BC313R

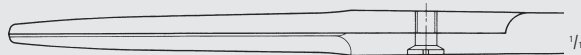

BC314R

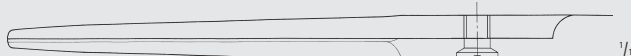

BC315R

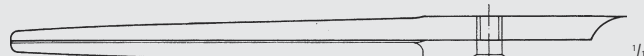

BC316R

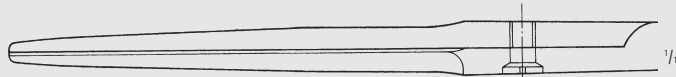

BC317R

General Surgery

Scissors



BC135R

1/2

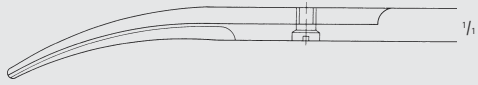

1/1

Suture Scissors

Catalog Number	Tip	Blade	Length (in.)
BC135R	B/B	DEL, CVD	4 3/4



BC411R-BC417R

COOPER Suture Scissors

Catalog Number	Tip	Blade	Length (in.)
BC411R	B/B	CVD	4 1/2
BC413R	B/B	CVD	5 1/8
BC414R	B/B	CVD	5 3/4
BC415R	B/B	CVD	6
BC416R	B/B	CVD	6 1/2
BC417R	B/B	CVD	7



BC411R

1/1



BC413R

1/1



BC414R

1/1

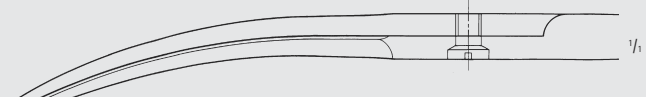

BC415R

1/1

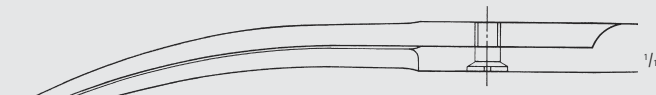

BC416R

1/1

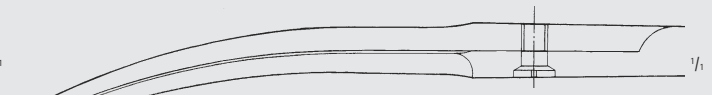

BC417R

1/1

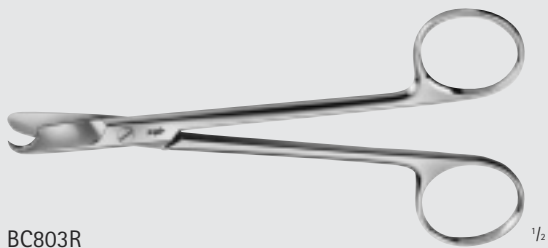

BC803R

1/2



1/1

LITTAUER Ligature Scissors

Catalog Number	Blade	Length (in.)
BC803R	STR	5 1/4

NORTHBENT Ligature Scissors

Catalog Number	Tip	Blade	Length (in.)
BC805R	B/B	LAT-CVD	4 3/4

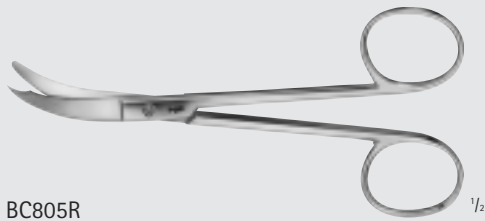

BC805R

1/2

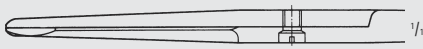

1/1

SPENCER Suture Scissors

Catalog Number	Blade	Length (in.)
BC801R	STR	3 1/2
BC802R	STR	4 1/2



BC801R-BC802R

1/2

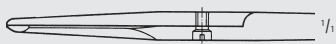

BC801R

1/1



BC802R

1/1

KNOWLES Bandage Scissors

Catalog Number	Blade	Length (in.)
BC846R	STR	5 3/4
BC847R	LAT-ANG	5 1/2



BC846R

1/2

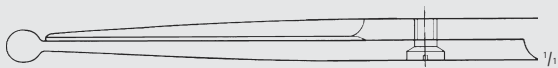

1/1



BC847R

1/2

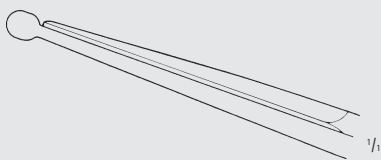

1/1



General Surgery

Scissors



BC848R-BC863R

LISTER Bandage Scissors

Catalog Number	Blade	Length (in.)
BC848R	LONG	6
BC849R	LONG	7
BC860R	STR	4 1/2
BC861R	STR	5 1/2
BC862R	STR	7
BC863R	STR	8

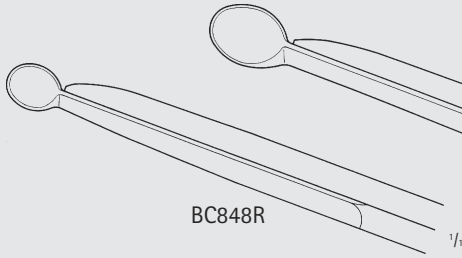

BC848R

1/1

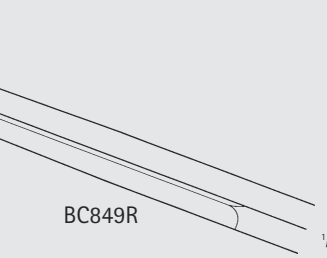

BC849R

1/1

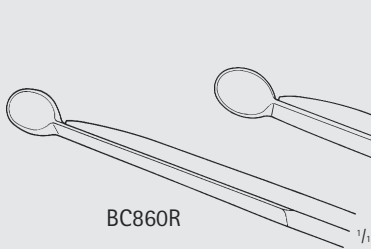

BC860R

1/1

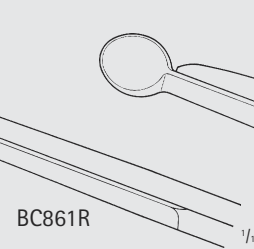

BC861R

1/1

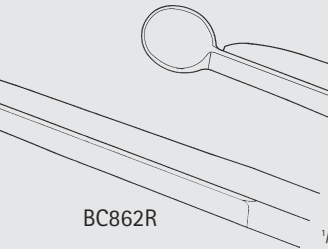

BC862R

1/1

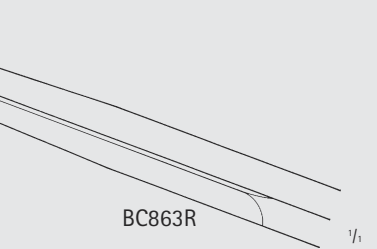

BC863R

1/1



MB223

1/2

LISTER Bandage Scissors W/One Large Ring

Catalog Number	Length (in.)
MB223	8





BC876R

1/2

LISTER Serrated Bandage Scissors

Catalog Number	Length (in.)
BC876R	6 1/4

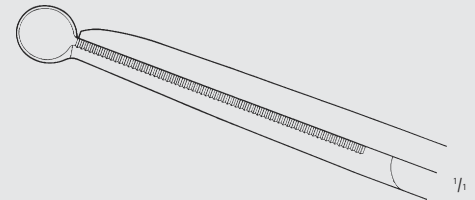

1/4



MB146R

1/4

LISTER Bandage Scissors

Catalog Number	Length (in.)
MB146R	3 1/2



1/4



BC890R

1/2

Nurse's Bandage Scissors

Catalog Number	Handle Color	Length (in.)
BC890R	RED	5 3/4

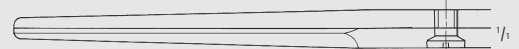

1/4

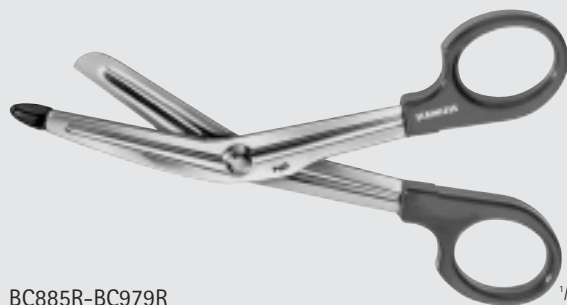

BC885R-BC979R

1/2

LISTER Universal Bandage Scissors

Catalog Number	Handle Color	Length (in.)
BC885R	BLACK	5 3/4
BC970R	RED	5 3/4
BC971R	BLUE	5 3/4
BC973R	YELLOW	5 3/4
BC975R	ORANGE	5 3/4
BC977R	PINK	5 3/4
BC978R	LIGHT GREEN	5 3/4
BC979R	VIOLET	5 3/4

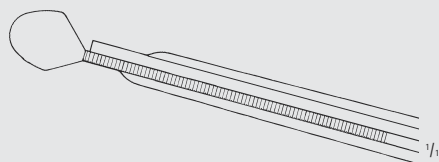

1/4



INCHES

General Surgery

Scissors

GENL

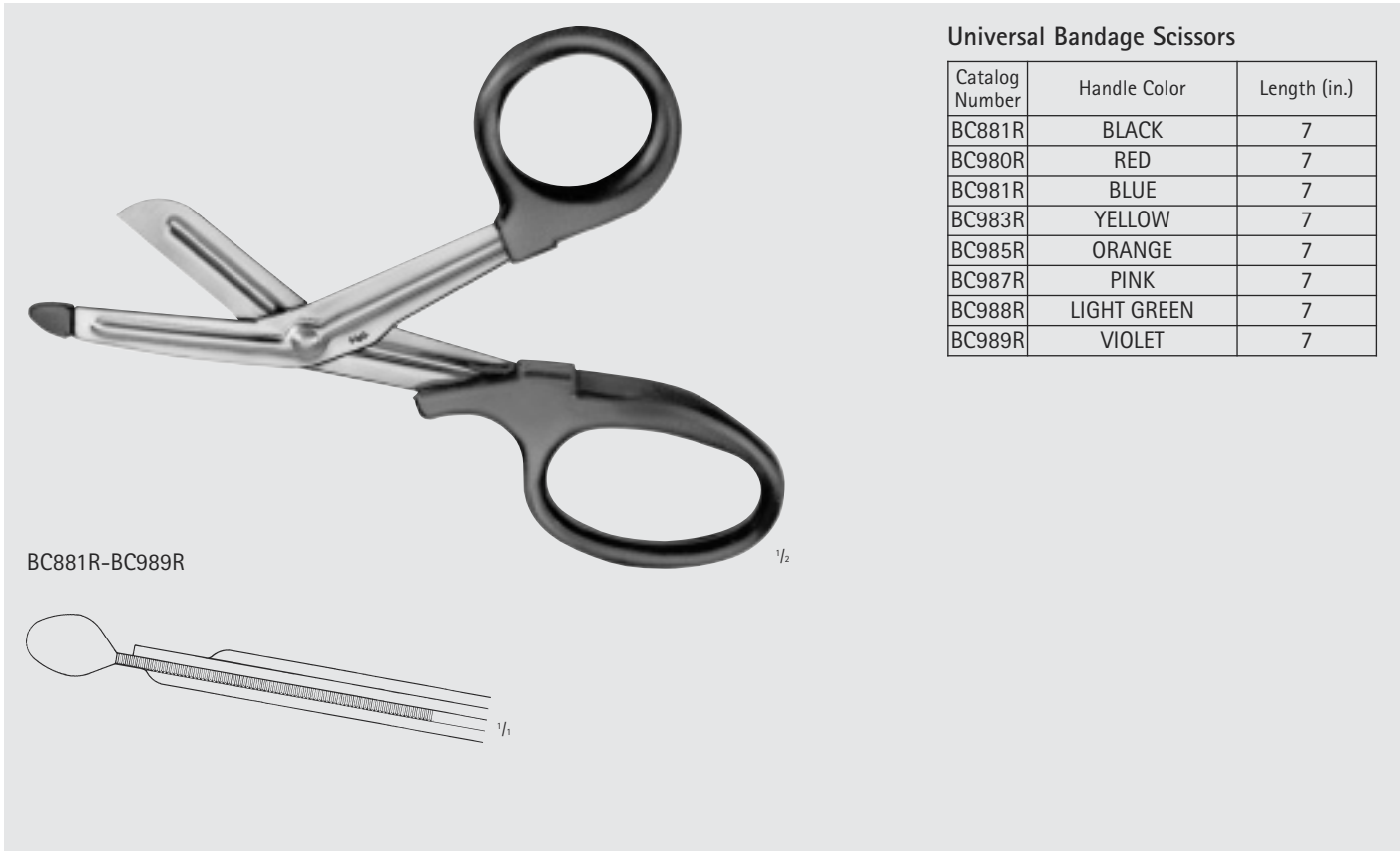
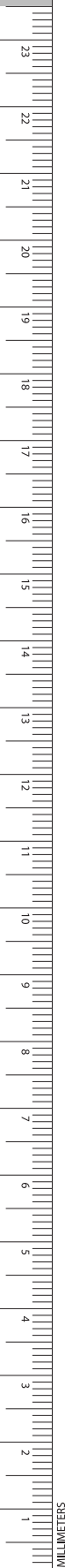

Universal Bandage Scissors

Catalog Number	Handle Color	Length (in.)
BC881R	BLACK	7
BC980R	RED	7
BC981R	BLUE	7
BC983R	YELLOW	7
BC985R	ORANGE	7
BC987R	PINK	7
BC988R	LIGHT GREEN	7
BC989R	VIOLET	7

BC881R-BC989R

1/2

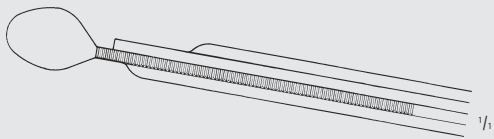

1/4

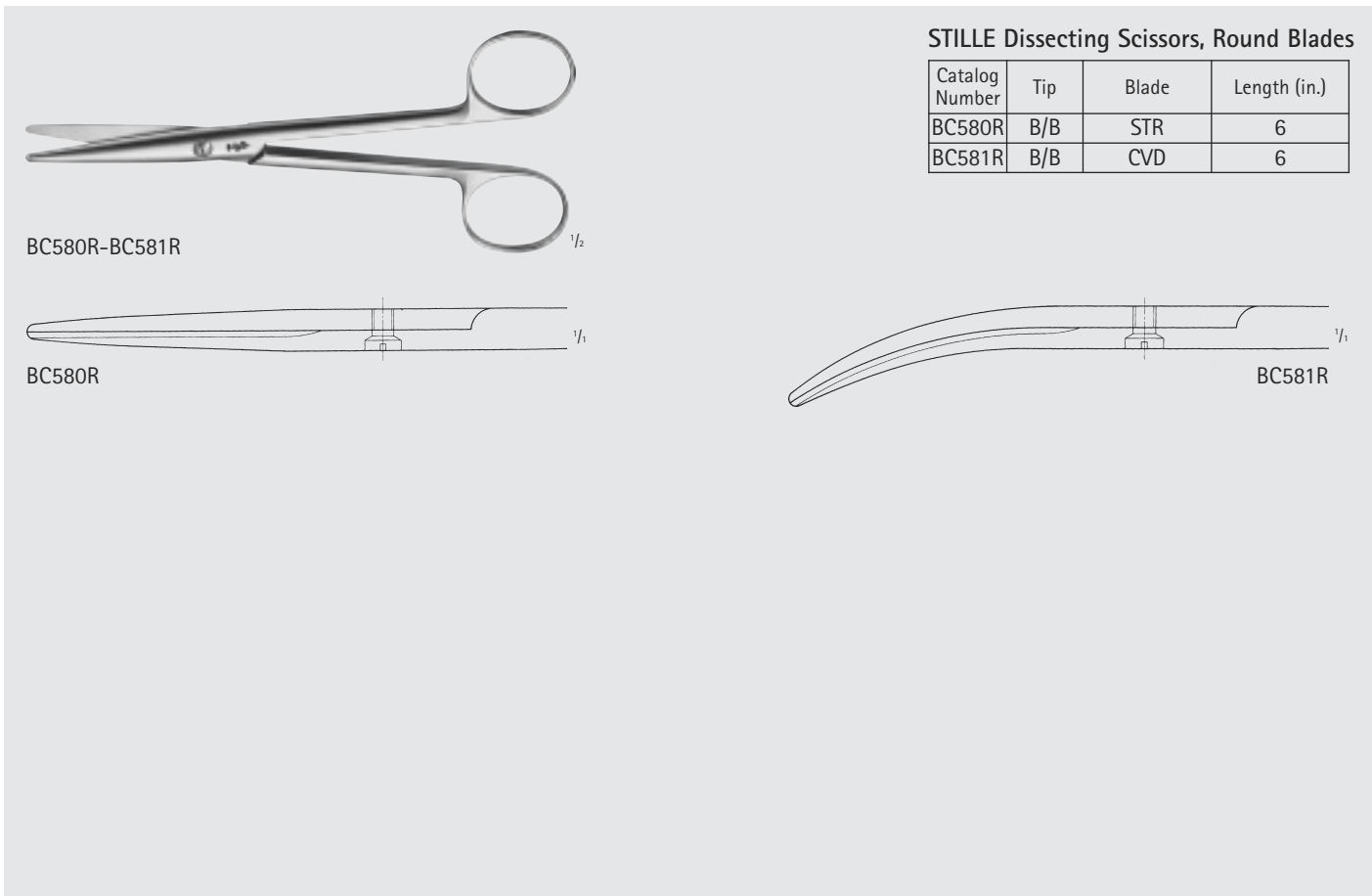

STILLE Dissecting Scissors, Round Blades

Catalog Number	Tip	Blade	Length (in.)
BC580R	B/B	STR	6
BC581R	B/B	CVD	6

BC580R-BC581R

1/2

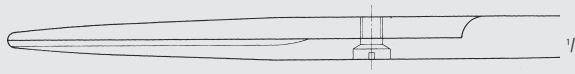

BC580R

1/4

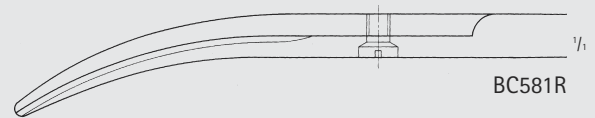

BC581R

1/4

MAYO Dissecting Scissors

Catalog Number	Tip	Blade	Length (in.)
BC584R	B/B	STR	6 1/2
BC585R	B/B	STR	8
BC587R	B/B	CVD	6 1/2
BC588R	B/B	CVD	8
BC589R	B/B	CVD	8 1/4



BC584R-BC589R

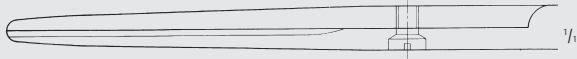

BC584R

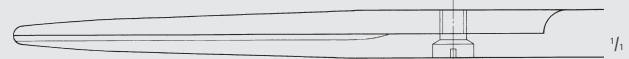

BC585R

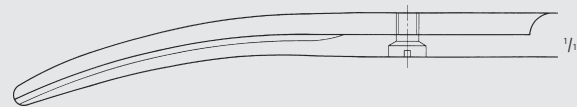

BC587R

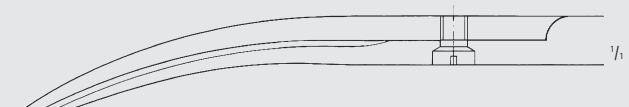

BC588R

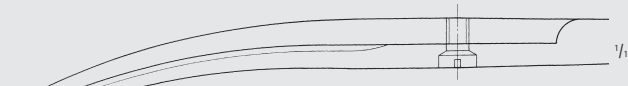

BC589R

MAYO-HARRINGTON Dissecting Scissors

Catalog Number	Tip	Blade	Length (in.)
BC560R	B/B	STR	9
BC561R	B/B	CVD	9

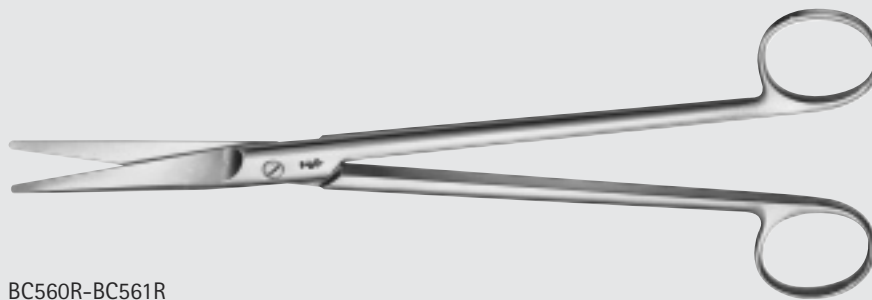

BC560R-BC561R

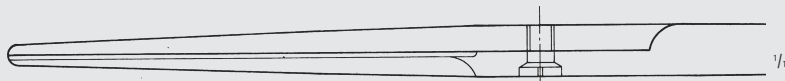

BC560R

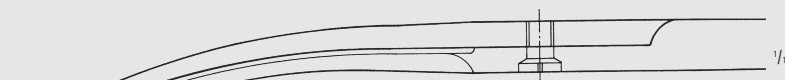

BC561R



INCHES

General Surgery

Scissors

MAYO-HARRINGTON Dissecting Scissors

Catalog Number	Tip	Blade	Length (in.)
BC567R	B/B	CVD	11
BC568R	B/B	STR	11

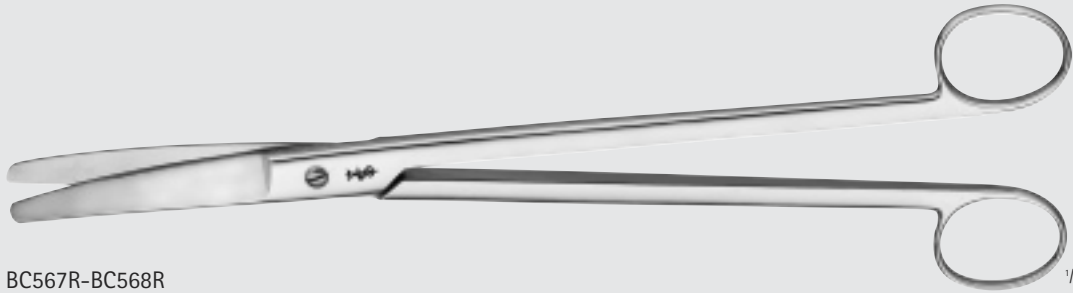

BC567R-BC568R



BC567R



BC568R

GENL

23
22
21
20
19
18
17
16
15
14
13
12
11
10
9
8
7
6
5
4
3
2
1
MILLIMETERS

MAYO Dissecting Scissors

Catalog Number	Tip	Blade	Length (in.)
BC544R	B/B	STR	5 1/2
BC545R	B/B	STR	6
BC547R	B/B	STR	6 3/4
BC554R	B/B	CVD	5 1/2
BC555R	B/B	CVD	6
BC557R	B/B	CVD	6 3/4
BC562R	B/B	STR	7 1/2
BC563R	B/B	CVD	7 1/2
BC564R	B/B	STR	8 1/2
BC565R	B/B	CVD	8 1/2



BC544R-BC557R

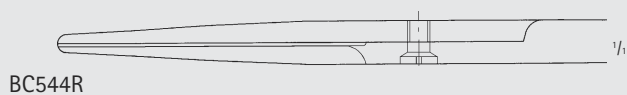

BC544R

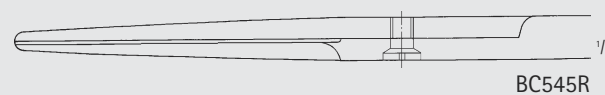

BC545R

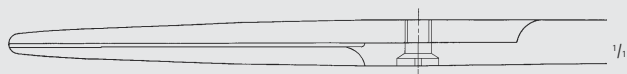

BC547R

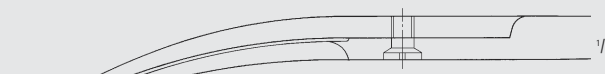

BC554R



BC555R



BC557R



BC562R-BC565R

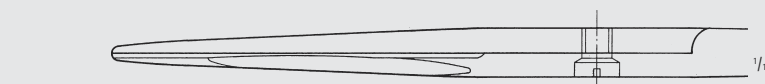

BC562R

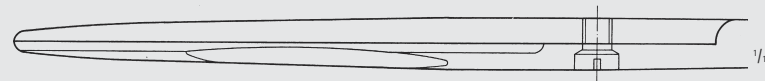

BC564R

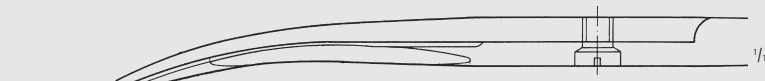

BC563R

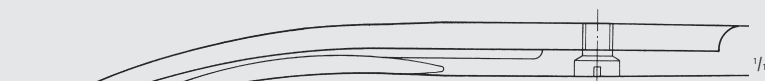

BC565R



INCHES

General Surgery

Scissors

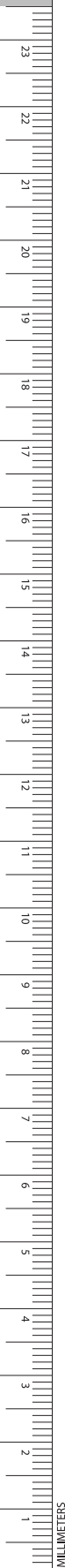

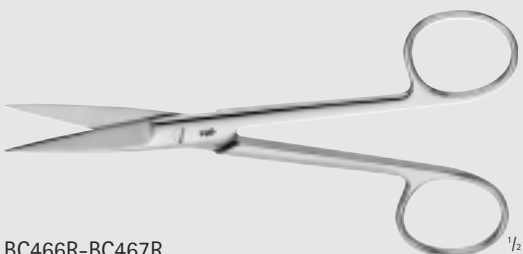

BC466R-BC467R 1/2

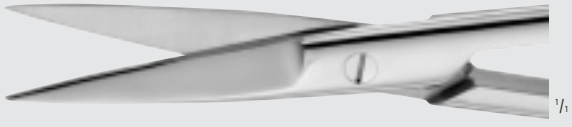

BC466R 1/4

MAYO Operating Scissors

Catalog Number	Tip	Blade	Length (in.)
BC466R	S/S	STR	5 1/2
BC467R	S/S	CVD	5 1/2



BC467R 1/4

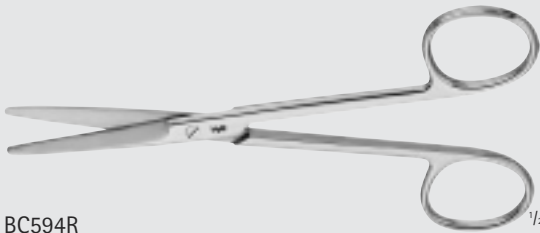

BC594R 1/2



1/4

MAYO Dissecting Scissors

Catalog Number	Tip	Blade	Length (in.)
BC594R	B/B	STR	5 1/2

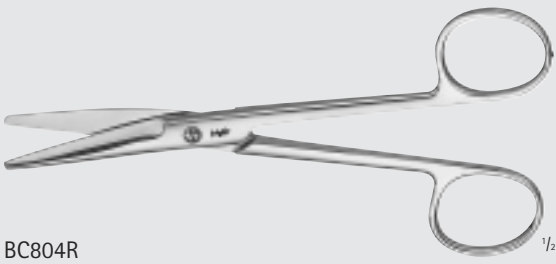

BC804R 1/2



1/4

NEW'S Suture Scissors

Catalog Number	Tip	Blade	Length (in.)
BC804R	B/B	ANG CVD	5 1/2

Suture Scissors

Catalog Number	Tip	Blade	Length (in.)
BC806R	B/B	STR	4 1/2



BC806R



LEXER Dissecting Scissors, Delicate

Catalog Number	Tip	Blade	Length (in.)
BC590R	B/B	STR	6 1/2
BC591R	B/B	CVD	6 1/2



BC590R-BC591R

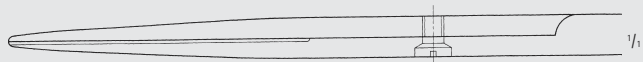

BC590R

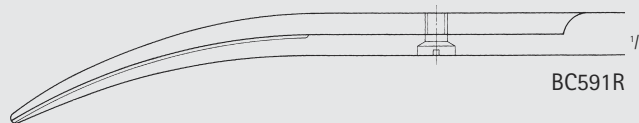

BC591R

MAYO-LEXER Dissecting Scissors

Catalog Number	Tip	Blade	Length (in.)
BC592R	B/B	CVD	6 1/2

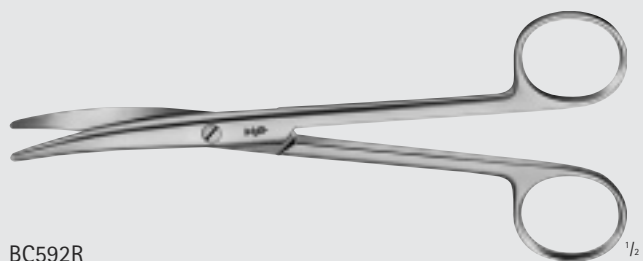

BC592R

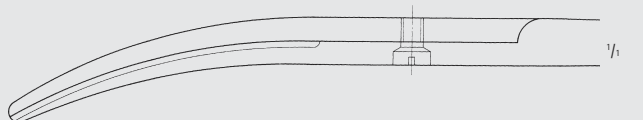

General Surgery

Scissors

GENL

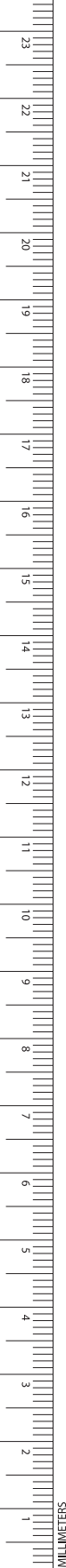
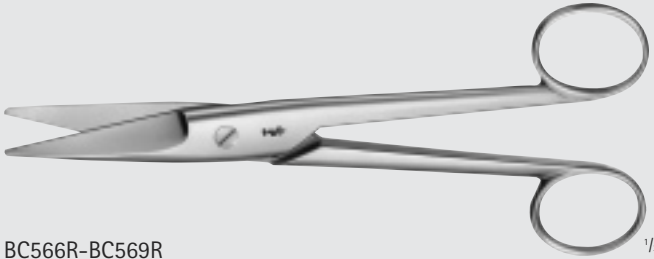

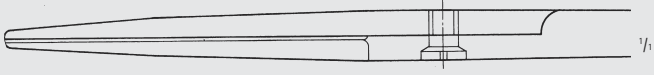

BC566R-BC569R $\frac{1}{2}$

Catalog Number	Tip	Blade	Length (in.)
BC566R	B/B	STR	6 3/4
BC569R	B/B	CVD	6 3/4

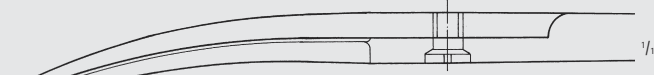

BC566R $\frac{1}{4}$



BC569R $\frac{1}{4}$



BC576R-BC579R $\frac{1}{2}$

Catalog Number	Tip	Blade	Length (in.)
BC576R	B/B	STR	5 1/2
BC577R	B/B	CVD	5 1/2
BC578R	B/B	STR	6 3/4
BC579R	B/B	CVD	6 3/4

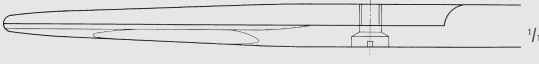

BC576R $\frac{1}{4}$

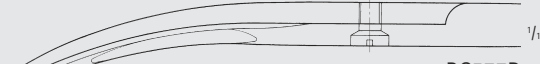

BC577R $\frac{1}{4}$

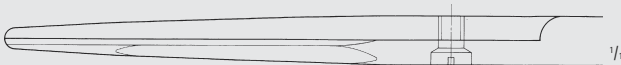

BC578R $\frac{1}{4}$

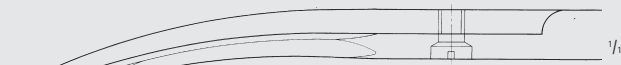

BC579R $\frac{1}{4}$



BC570R-BC575R $\frac{1}{2}$

Catalog Number	Tip	Blade	Length (in.)
BC570R	B/B	STR	5 1/2
BC572R	B/B	STR	6 3/4
BC573R	B/B	CVD	5 1/2
BC575R	B/B	CVD	6 3/4

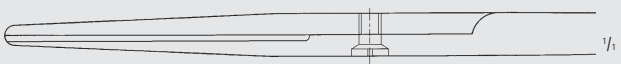

BC570R $\frac{1}{4}$

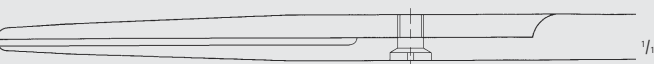

BC572R $\frac{1}{4}$

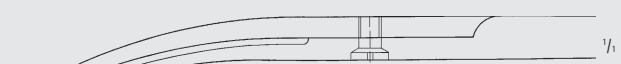

BC573R $\frac{1}{4}$

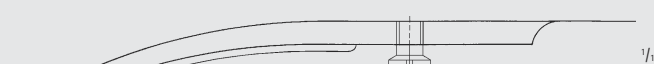

BC575R $\frac{1}{4}$

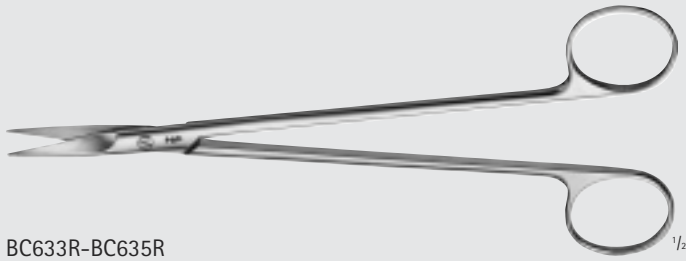

BC633R-BC635R

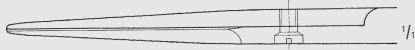

BC633R

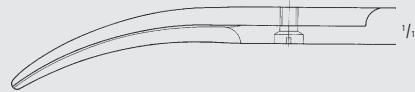

BC635R

TOENNIS Dissecting Scissors

Catalog Number	Tip	Blade	Length (in.)
BC633R	B/B	X-DEL, STR	7
BC634R	B/B	DEL, STR	7
BC635R	B/B	DEL, CVD	7

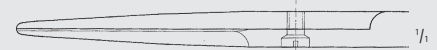

BC634R

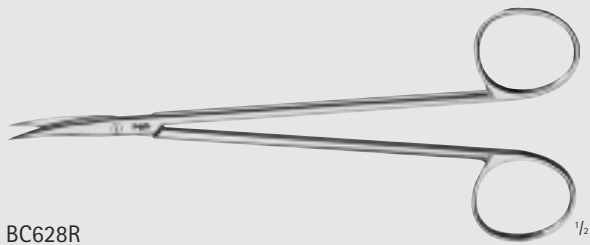

BC628R

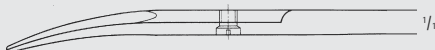

Nerve Dissecting Scissors

Catalog Number	Tip	Blade	Length (in.)
BC628R	S/S	CVD	6

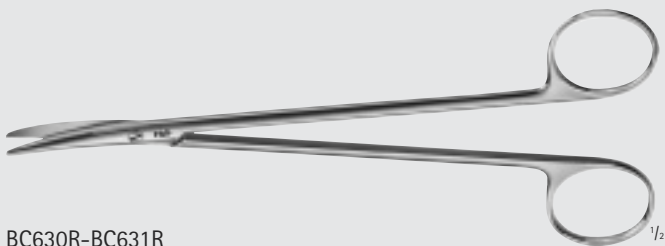

BC630R-BC631R

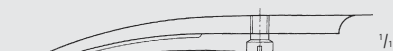

BC630R

TOENNIS-ADSON Dissecting Scissors

Catalog Number	Tip	Blade	Length (in.)
BC630R	X-DEL	CVD	7
BC631R	DEL	CVD	7

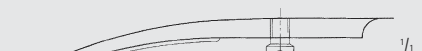

BC631R



General Surgery

Scissors

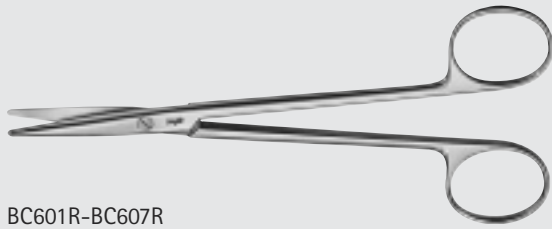

BC601R-BC607R

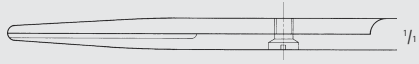

BC601R

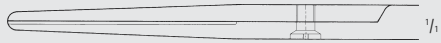

BC602R

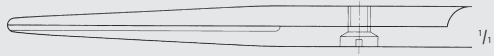

BC604R

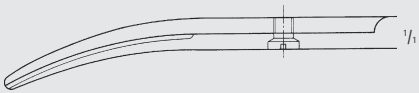

BC605R

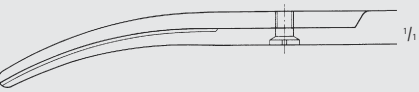

BC606R

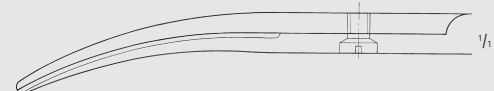

BC607R

METZENBAUM Dissecting Scissors

Catalog Number	Tip	Blade	Length (in.)
BC601R	B/B	STR	5 3/4
BC602R	B/B	STR	7
BC604R	B/B	STR	8
BC605R	B/B	CVD	5 3/4
BC606R	B/B	CVD	7
BC607R	B/B	CVD	8

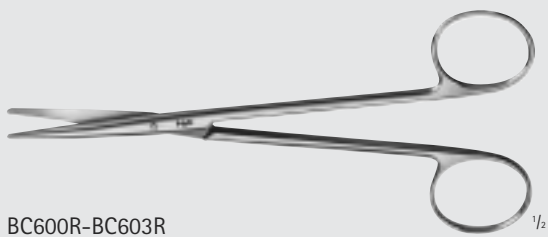

BC600R-BC603R

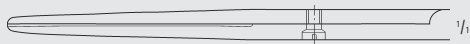

BC600R

BABY-METZENBAUM Dissecting Scissors, Delicate

Catalog Number	Tip	Blade	Length (in.)
BC600R	B/B	STR	5 3/4
BC603R	B/B	CVD	5 3/4

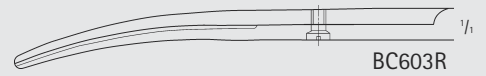

BC603R

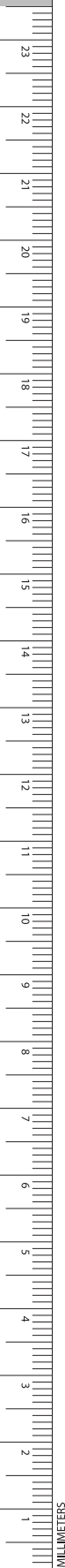

NELSON-METZENBAUM Dissecting Scissors

Catalog Number	Tip	Blade	Length (in.)
BC611R	B/B	STR	9
BC612R	B/B	STR	10
BC613R	B/B	STR	11
BC614R	B/B	STR	12
BC615R	B/B	CVD	9
BC616R	B/B	CVD	10
BC618R	B/B	CVD	11
BC619R	B/B	CVD	12

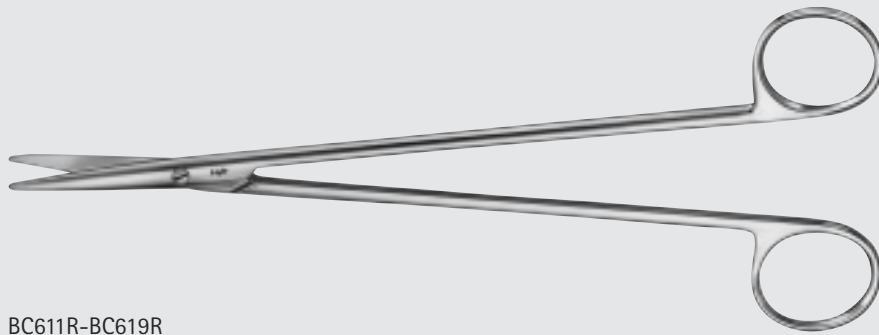

BC611R-BC619R

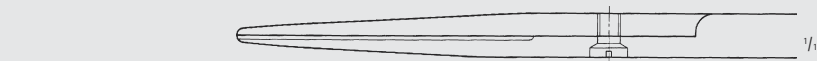

BC611R

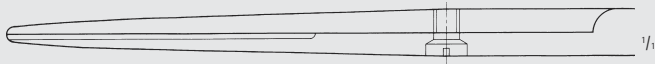

BC612R

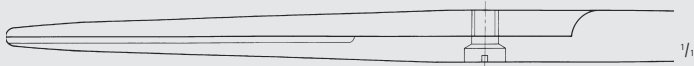

BC613R

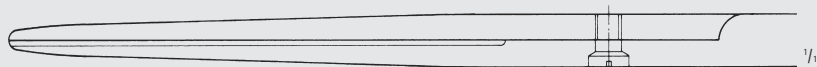

BC614R

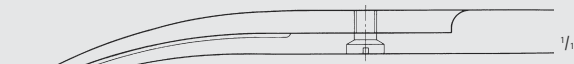

BC615R

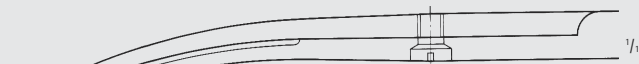

BC616R

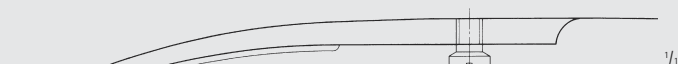

BC618R

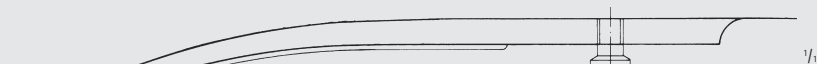

BC619R



INCHES

General Surgery

Scissors

GENL

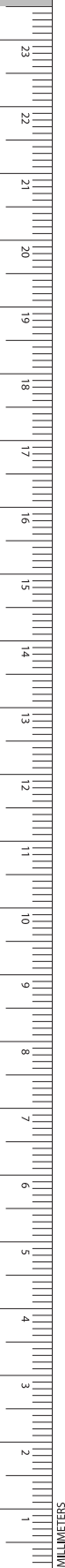

NELSON-METZENBAUM Dissecting Scissors, Delicate

Catalog Number	Tip	Blade	Length (in.)
BC625R	B/B	CVD	14

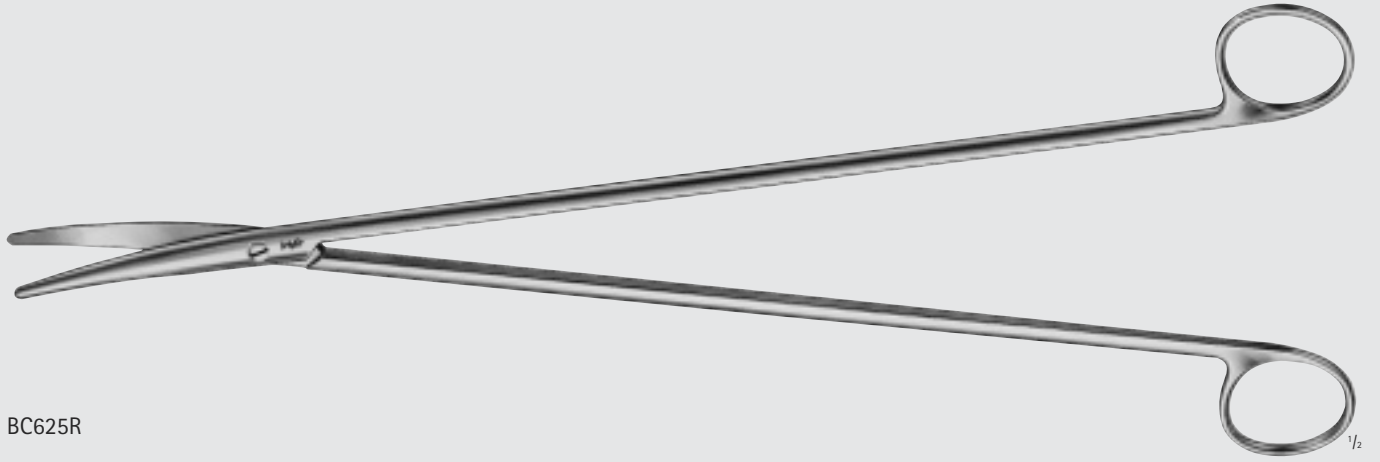

BC625R



WELLER Dissecting Scissors

Catalog Number	Tip	Blade	Length (in.)
BC620R	B/B	HVY-CVD	11

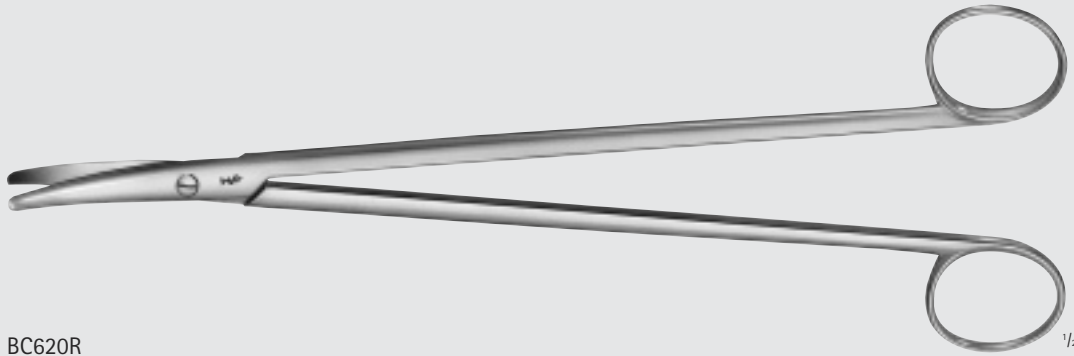

BC620R

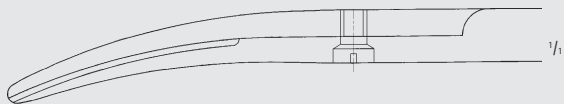

Abdominal Scissors

Catalog Number	Tip	Blade	Length (in.)
BC774R	B/B	STR	7



BC774R

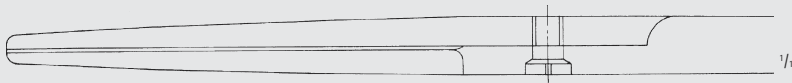

Rectal Scissors

Catalog Number	Tip	Blade	Length (in.)
BC617R	B/B	HVY-CVD	13

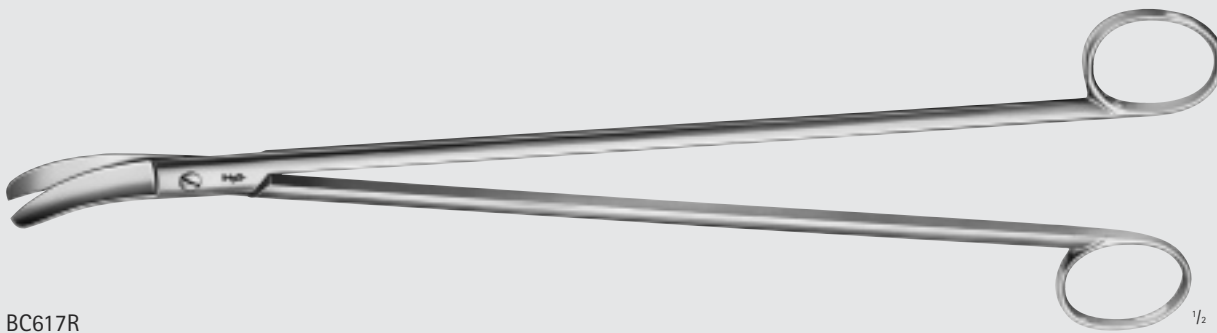

BC617R

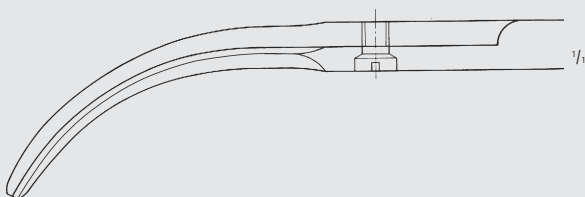

INCHES

General Surgery

Scissors

GENL

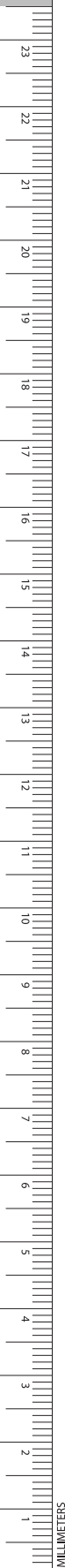

LLOYD-DAVIES Rectal Scissors

Catalog Number	Tip	Blade	Length (in.)
BC621R	B/B	CVD	10 3/4

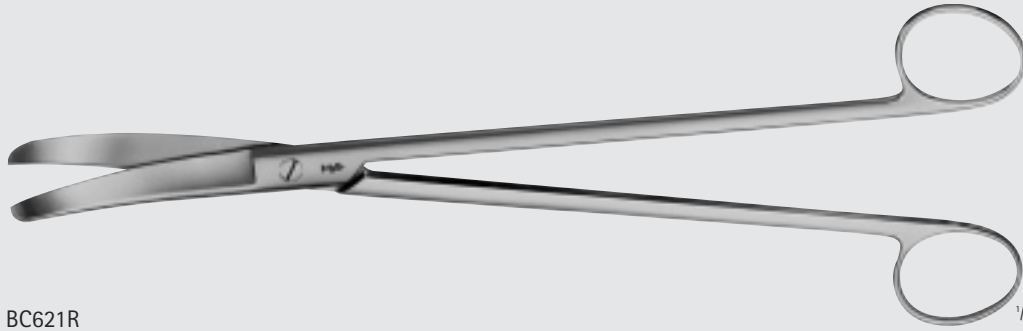

BC621R

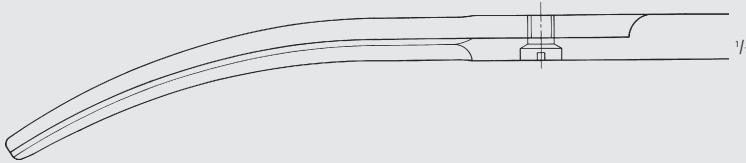

STELZNER Rectal Scissors

Catalog Number	Tip	Blade	Length (in.)
BC622R	B/B	STR	12 3/8
BC623R	B/B	CVD	12 3/8

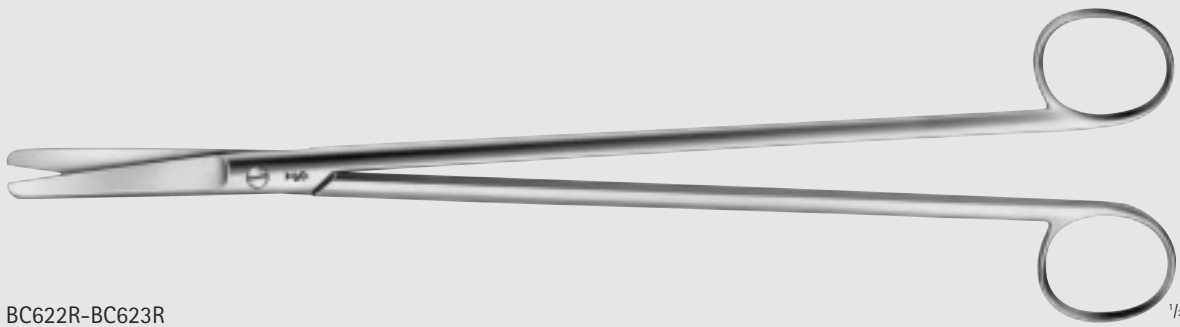

BC622R-BC623R

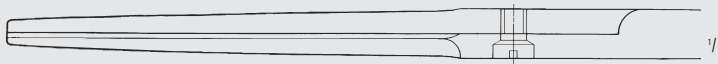

BC622R

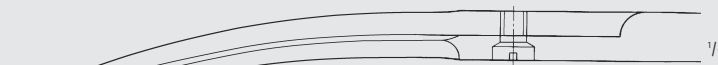

BC623R

MUELLER Rectal Scissors

Catalog Number	Tip	Blade	Length (in.)
BC627R	B/B	CVD	13

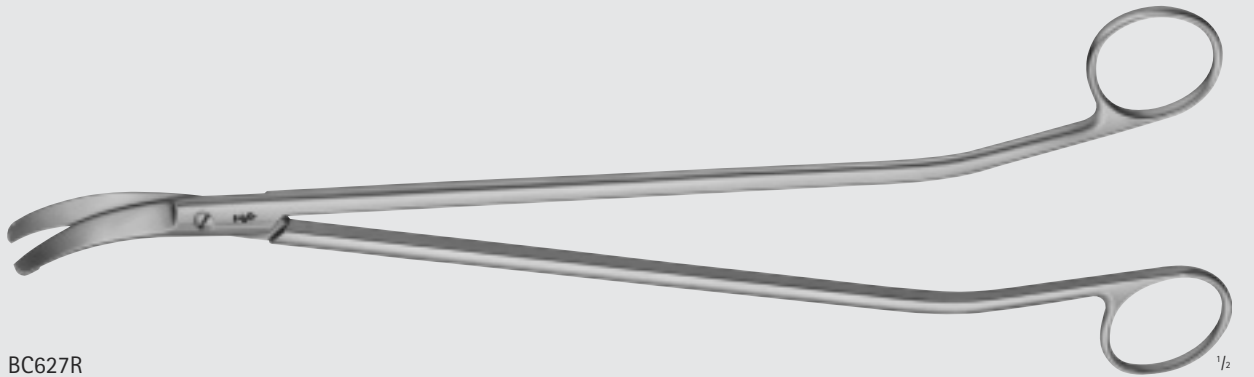

BC627R

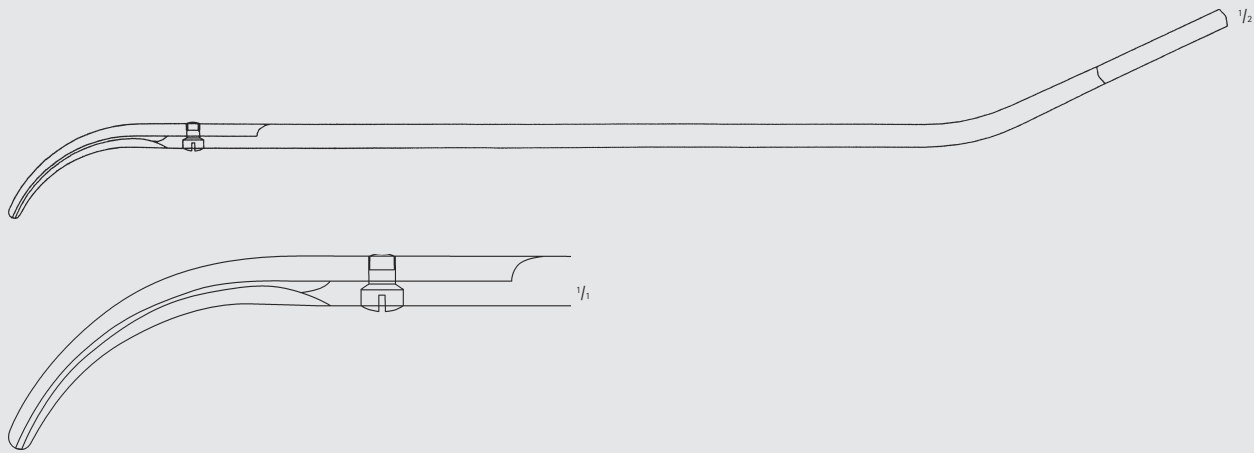

HARVEY Wire Scissors

Catalog Number	Tip	Blade	Length (in.)
BC815R	B/B	SERR	5

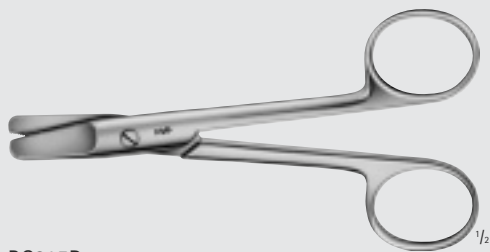

BC815R

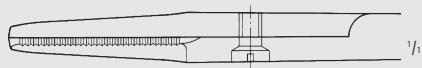

General Surgery

Scissors

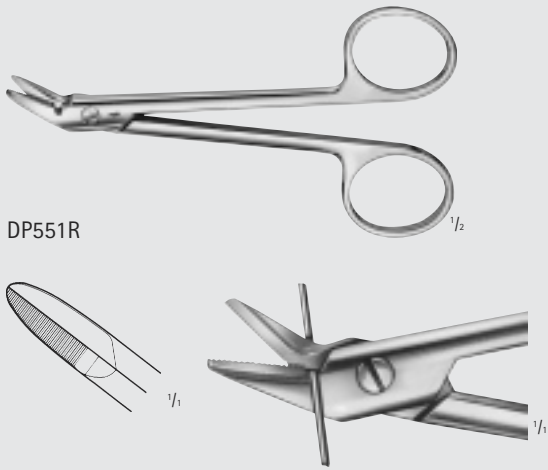

DP551R

Wire Cutting Scissors

Catalog Number	For Wire Size	Length (in.)
DP551R	SOFT, UP TO 1.2MM AND HARD, UP TO 0.6 MM	4 3/4

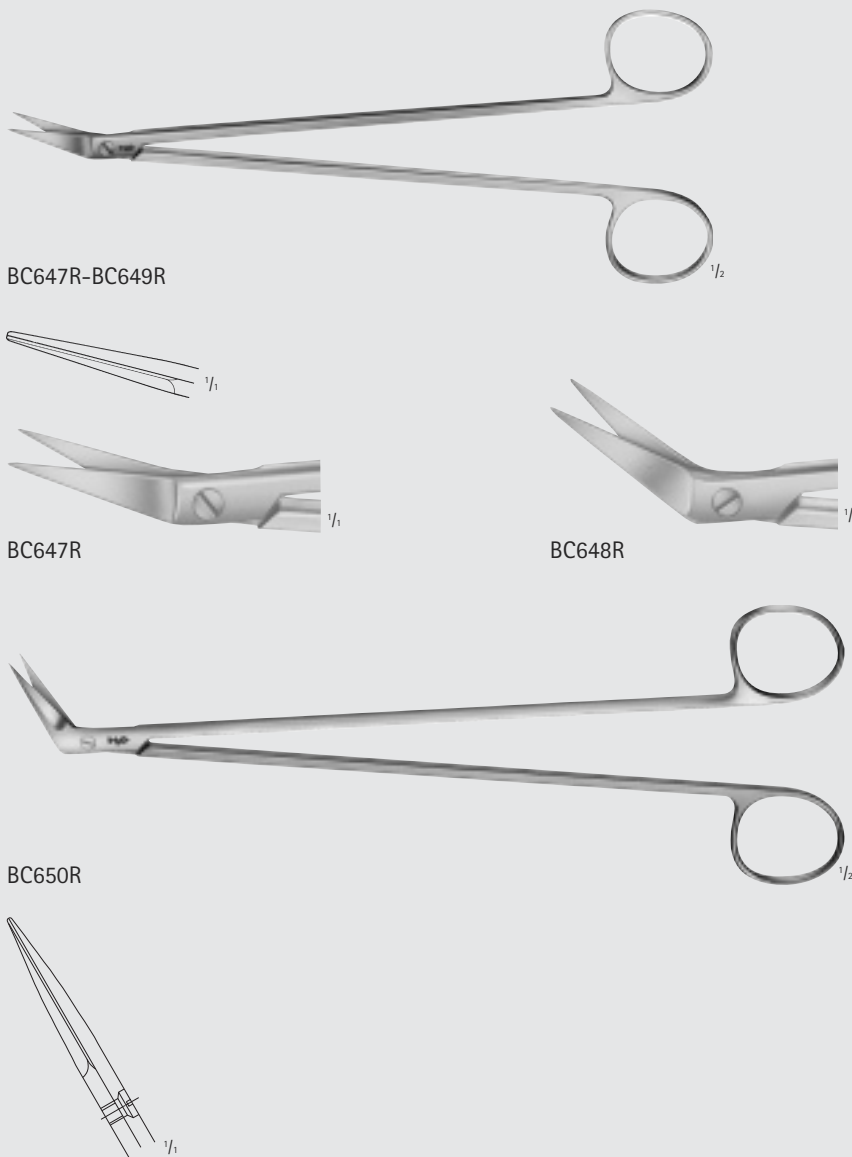

BC647R-BC649R

BC647R

BC648R

BC649R

BC650R

POTTS-DE MARTEL Scissors

Catalog Number	Tip	Blade	Length (in.)
BC647R	S/S	30°	7 1/4
BC648R	S/S	45°	7 1/4
BC649R	S/S	60°	7 1/4
BC650R	S/S	60°	8 3/4

MILLIMETERS

MILLS Scissors

Catalog Number	Tip	Blade	Length (in.)
BC651R	1 BALL-PT	60°	8 3/4

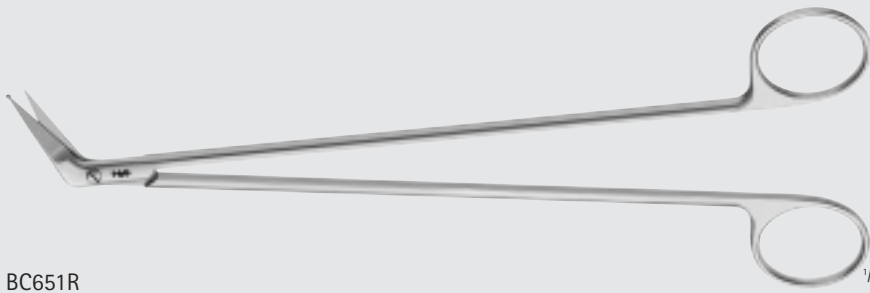

BC651R

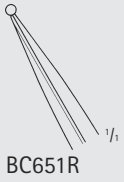

BC651R

Iris Scissors, Delicate

Catalog Number	Tip	Blade	Length (in.)
BC004R	S/S	STR	4 1/2
BC005R	S/S	CVD	4 1/2

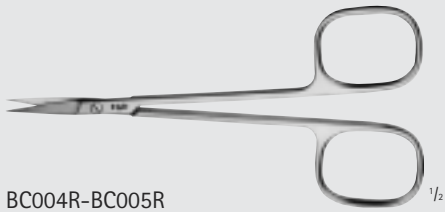

BC004R-BC005R

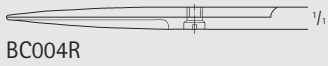

BC004R

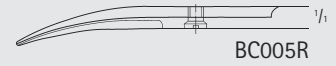

BC005R



General Surgery

Delicate Scissors

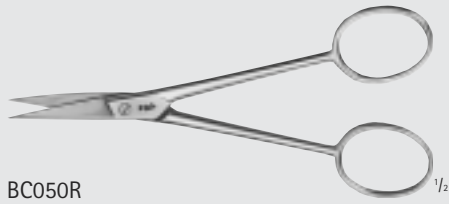

BC050R

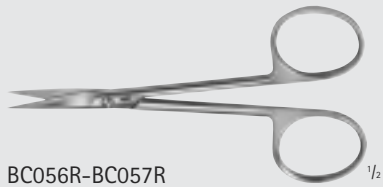
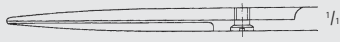

BC056R-BC057R

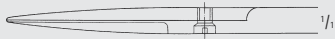

BC056R



BC060R-BC061R

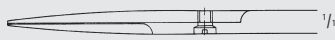

BC060R

Iris Scissors

Catalog Number	Tip	Blade	Length (in.)
BC050R	S/S	STR	4 3/8
BC056R	S/S	STR	3 3/4
BC057R	S/S	CVD	3 3/4
BC060R	S/S	STR	4 1/8
BC061R	S/S	CVD	4 1/8

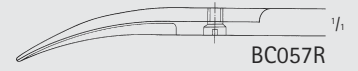

BC057R

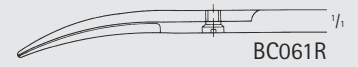

BC061R

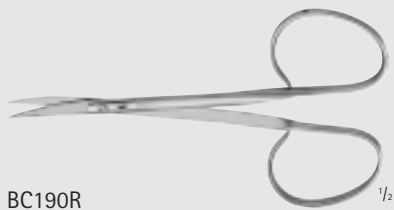

BC190R

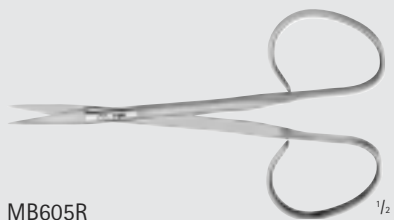

MB605R



Iris Scissors

Catalog Number	Tip	Blade	Length (in.)
BC190R	S/S	CVD	4
MB605R	S/S	STR	4

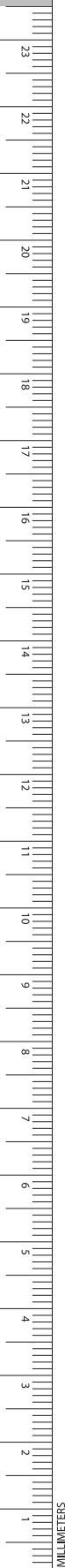

Iris Scissors

Catalog Number	Tip	Blade	Length (in.)
BC064R	S/S	STR	4 3/4
BC065R	S/S	CVD	4 3/4
BC100R	S/S	STR	3 1/2
BC101R	S/S	CVD	3 1/2
BC110R	S/S	STR	4 3/8
BC111R	S/S	CVD	4 3/8
BC112R	S/B	STR	4 3/8
BC113R	S/B	CVD	4 3/8
BC117R	S/S	LAT-ANG	4 3/8



BC064R-BC065R



BC064R

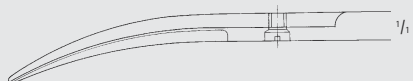

BC065R



BC100R-BC101R

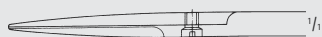

BC100R

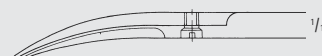

BC101R

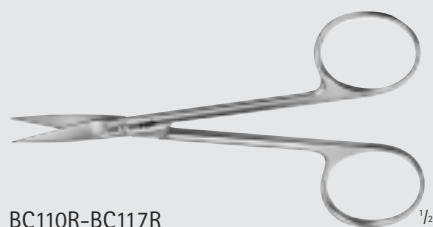

BC110R-BC117R

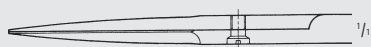

BC110R



BC111R

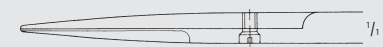

BC117R

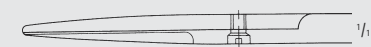

BC112R



BC113R



BC117R



General Surgery

Delicate Scissors

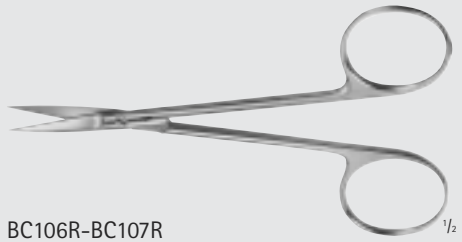

BC106R-BC107R

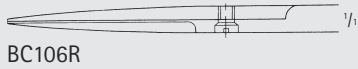

BC106R

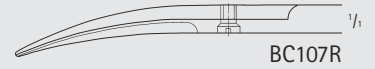

BC107R

Iris Scissors

Catalog Number	Tip	Blade	Length (in.)
BC106R	S/S	STR	4 1/2
BC107R	S/S	CVD	4 1/2



BC006R-BC007R

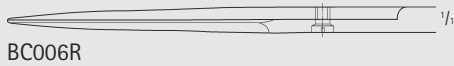

BC006R

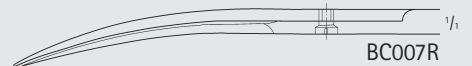

BC007R

JOSEPH Scissors

Catalog Number	Tip	Blade	Handle	Length (in.)
BC006R	S/S	STR	SQUARE	6
BC007R	S/S	CVD	SQUARE	6
BC156R	S/S	STR	ROUND	6
BC157R	S/S	CVD	ROUND	6
MB174R	S/S	STR, SERR	ROUND	5 1/2
MB175R	S/S	CVD, SERR	ROUND	5 1/2



BC156R-BC157R

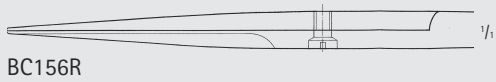

BC156R

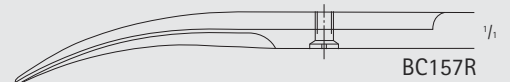

BC157R



MB174R-MB175R



MB174R



MB175R

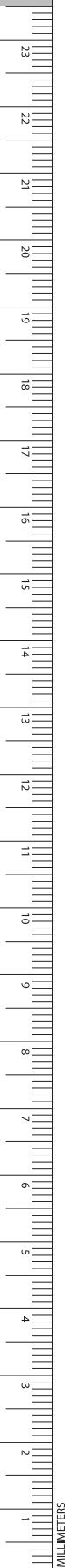



JAMESON Tenotomy Scissors

Catalog Number	Tip	Blade	Length (in.)
BC177R	B/B	CVD	6

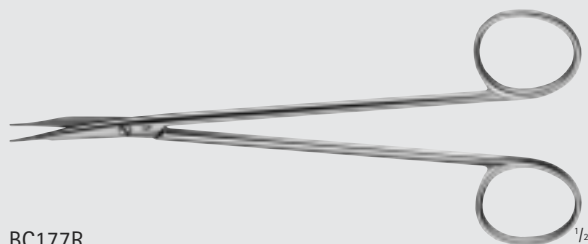

BC177R



REYNOLDS-JAMESON Tenotomy Scissors

Catalog Number	Tip	Blade	Length (in.)
BC015R	B/B	CVD	5 1/2

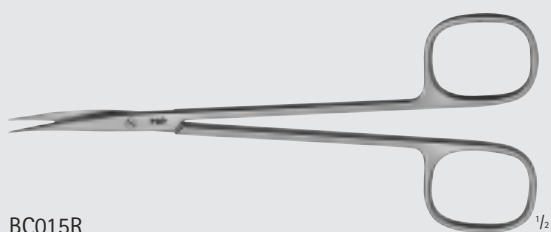

BC015R

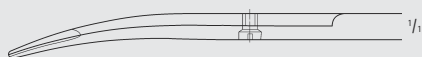

REYNOLDS Tenotomy Scissors

Catalog Number	Tip	Blade	Length (in.)
BC180R	B/B	CVD	5 3/4
BC181R	B/B	CVD	7

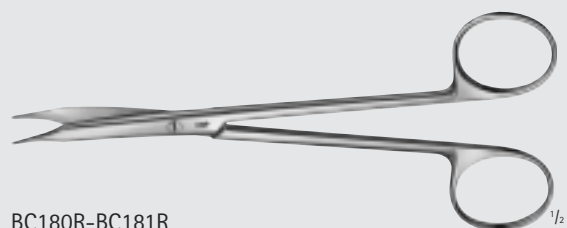

BC180R-BC181R

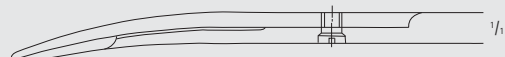

BC180R



BC181R

STEVENS Tenotomy Scissors, Fine

Catalog Number	Tip	Blade	Length (in.)
BC194R	B/B	STR	5
BC195R	B/B	CVD	5



BC194R-BC195R

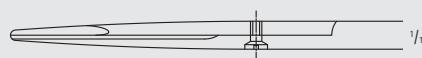

BC194R

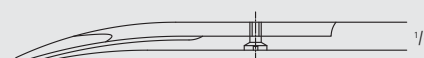

BC195R

General Surgery

Delicate Scissors

GENL

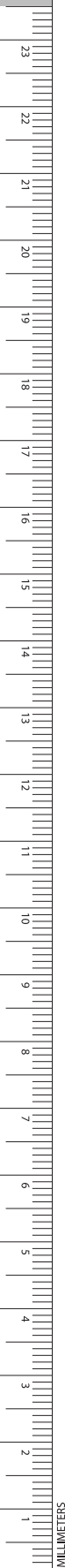

BC660R

SCHMIEDEN-TAYLOR Dura Scissors, Fine

Catalog Number	Tip	Blade	Length (in.)
BC660R	1 BALL-PT	ANG	6

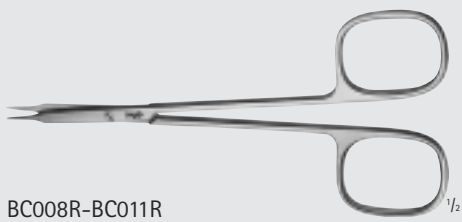
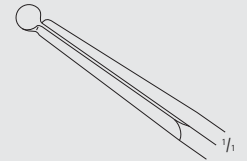

BC008R-BC011R

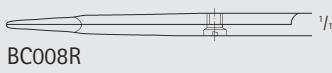

BC008R

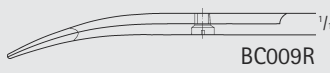

BC009R

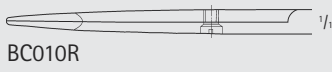

BC010R

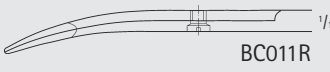

BC011R

STEVENS Tenotomy Scissors

Catalog Number	Tip	Blade	Handle	Length (in.)
BC008R	S/S	STR	SQUARE	4 1/2
BC009R	S/S	CVD	SQUARE	4 1/2
BC010R	B/B	STR	SQUARE	4 1/2
BC011R	B/B	CVD	SQUARE	4 1/2
BC170R	S/S	STR	ROUND	4 3/8
BC171R	S/S	CVD	ROUND	4 3/8
BC172R	B/B	STR	ROUND	4 3/8
BC173R	B/B	CVD	ROUND	4 3/8



BC170R-BC173R

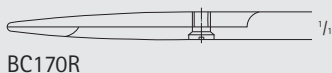

BC170R

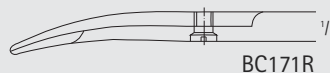

BC171R

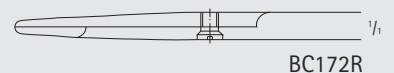

BC172R

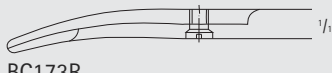

BC173R

Strabismus Scissors

Catalog Number	Tip	Blade	Length (in.)
BC020R	B/B	STR	4 1/2
BC021R	B/B	CVD	4 1/2

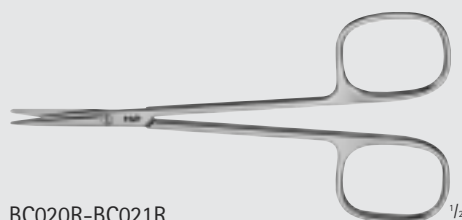

BC020R-BC021R

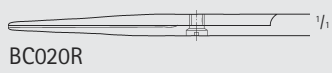

BC020R

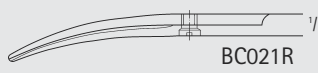

BC021R



BC164R-BC165R



BC164R

Strabismus Scissors

Catalog Number	Tip	Blade	Length (in.)
BC164R	B/B	STR	4 1/2
BC165R	B/B	CVD	4 1/2

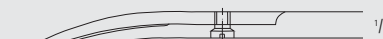

BC165R

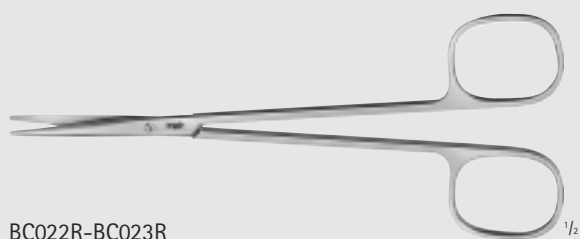

BC022R-BC023R



BC022R

METZENBAUM Dissecting Scissors

Catalog Number	Tip	Blade	Length (in.)
BC022R	B/B	STR	5 3/4
BC023R	B/B	CVD	5 3/4

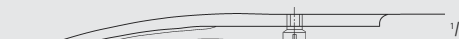

BC023R

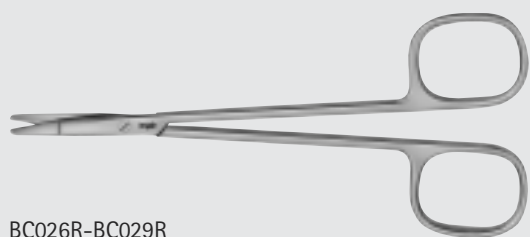

BC026R-BC029R

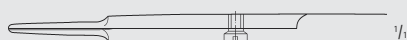

BC026R

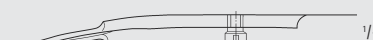

BC027R

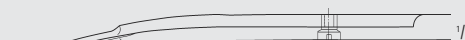

BC029R

RAGNELL Dissecting Scissors

Catalog Number	Tip	Blade	Length (in.)
BC026R	B/B	STR	5 1/4
BC027R	B/B	CVD	5 1/4
BC029R	B/B	CVD	6



General Surgery

Delicate Scissors

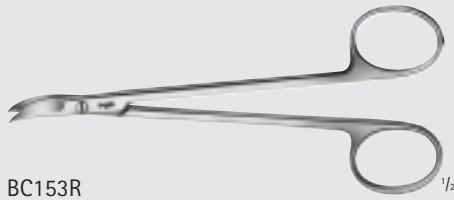

BC153R

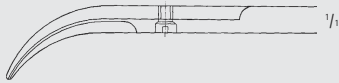

CHADWICK Delicate Scissors

Catalog Number	Tip	Blade	Length (in.)
BC153R	S/S	CVD	4 1/2



BC154R

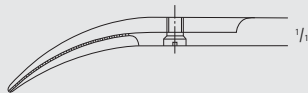

LA GRANGE Scissors

Catalog Number	Tip	Blade	Length (in.)
BC154R	S/S	1-SERR	4 3/8

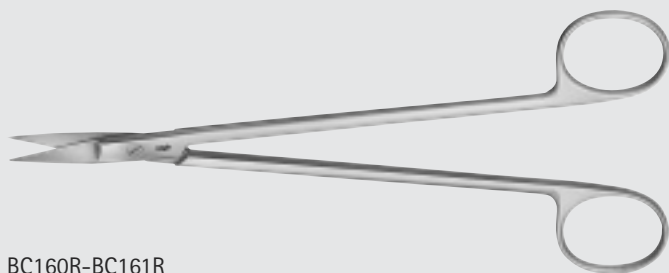

BC160R-BC161R

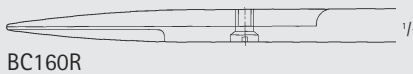

BC160R

KELLY Scissors

Catalog Number	Tip	Blade	Length (in.)
BC160R	S/S	STR	7
BC161R	S/S	CVD	7

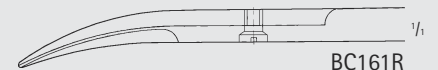

BC161R

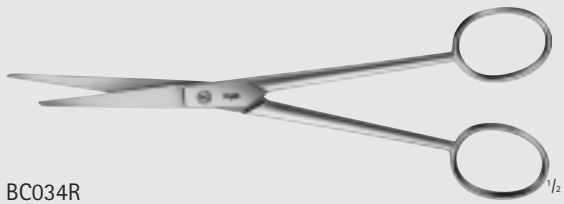

BC034R

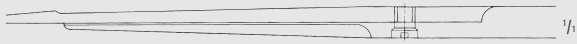

Delicate Scissors

Catalog Number	Tip	Blade	Length (in.)
BC034R	B/B	1-PROBE-PT	5 3/4

MAYO Dissecting Scissors
W/One Large Ring

Catalog Number	Tip	Blade	Length (in.)
MB148R	B/B	HVY	14

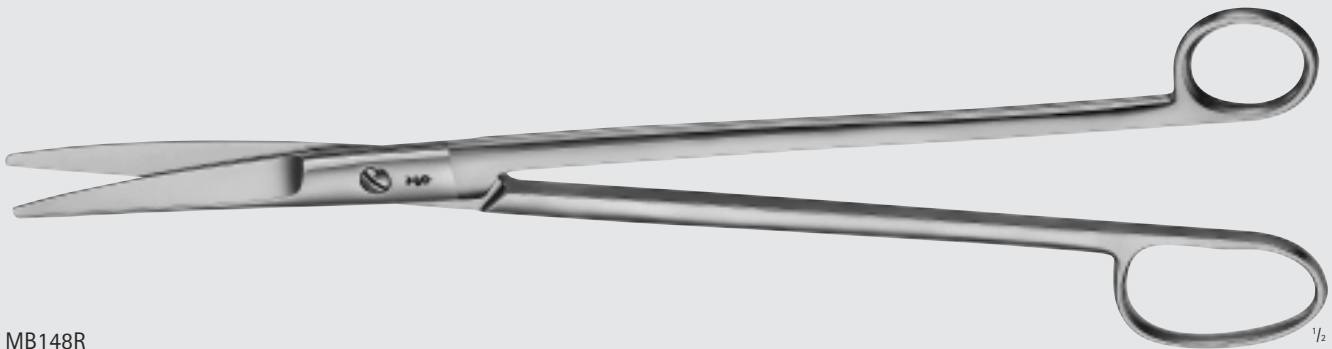

MB148R



MAYO-SIMS Dissecting Scissors

Catalog Number	Tip	Blade	Length (in.)
MB149R	B/B	STR	7 3/4

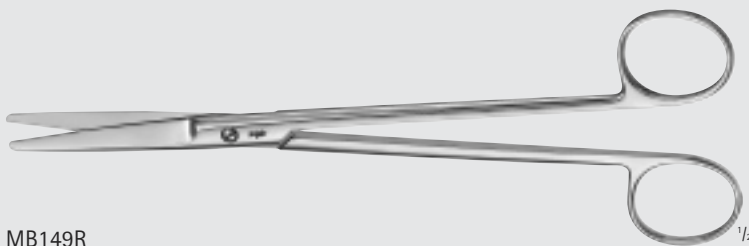

MB149R



INCHES

General Surgery

DUROTIP® TC Scissors

DUROTIP Tungsten Carbide Scissors

- Excellent cutting accuracy
- Long working life
- Gold-plated rings

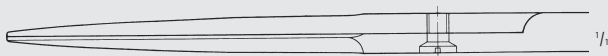
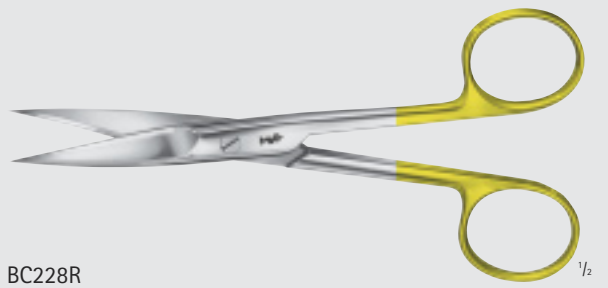
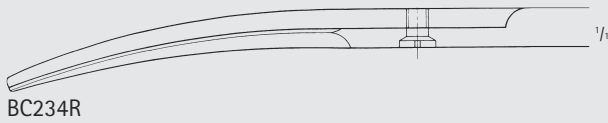
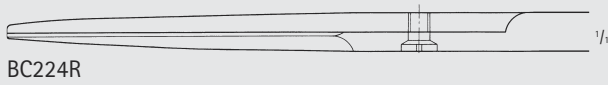
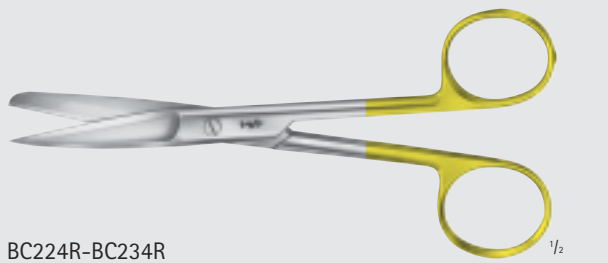

DUROTIP TC Suture Scissors

Catalog Number	Tip	Blade	Length (in.)
BC224R	S/B	STR	5 3/4
BC234R	S/B	CVD	5 3/4
BC228R	S/S	STR	5 3/4

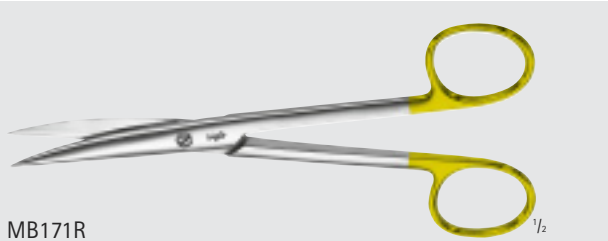

DUROTIP TC Operating Scissors

Catalog Number	Tip	Blade	Length (in.)
MB171R	S/S	CVD	5 3/4

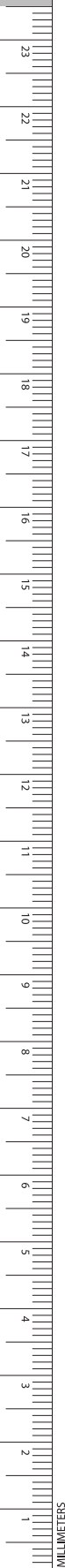

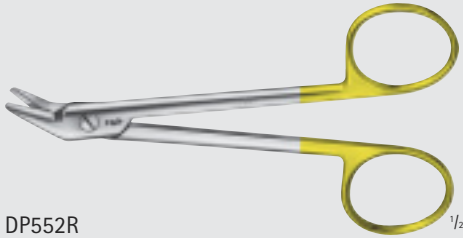

DP552R 1/2

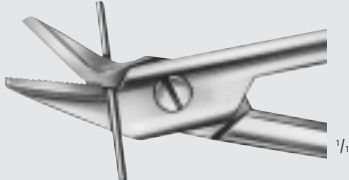

1/4

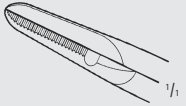

1/4

DUROTIP TC Wire Cutting Scissors

Catalog Number	Blade	For Wire Size	Length (in.)
DP552R	1-SERR	SOFT, UP TO 1.2MM AND HARD, UP TO 0.8 MM	4 3/4

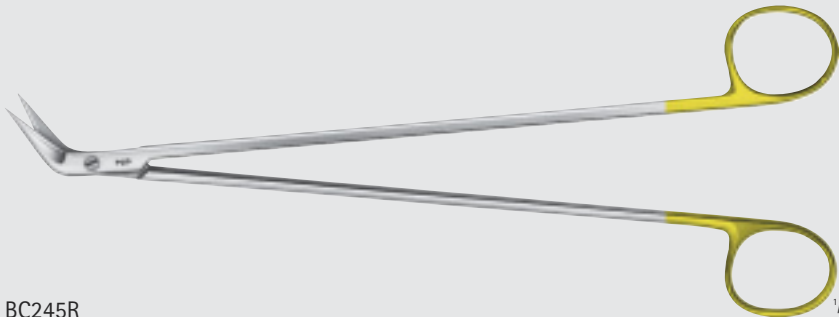

BC245R 1/2

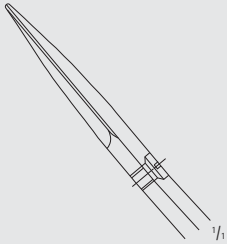

1/4

DUROTIP TC DE BAKY Vascular Scissors

Catalog Number	Tip	Blade	Length (in.)
BC245R	S/S	60°	8 3/4



BC284R 1/2

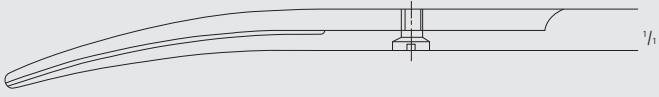

1/4

DUROTIP TC MAYO-LEXER Dissecting Scissors

Catalog Number	Tip	Blade	Length (in.)
BC284R	B/B	CVD	6 1/2



General Surgery
DUROTIP® TC Scissors

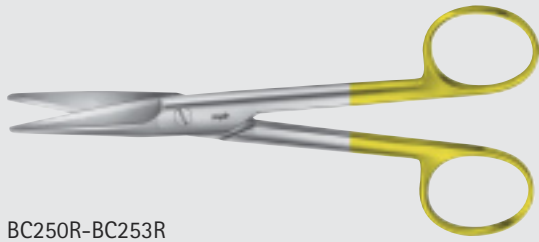

BC250R-BC253R

DUROTIP TC MAYO Dissecting Scissors

Catalog Number	Tip	Blade	Length (in.)
BC250R	B/B	STR	5 1/2
BC251R	B/B	CVD	5 1/2
BC252R	B/B	STR	6 3/4
BC253R	B/B	CVD	6 3/4

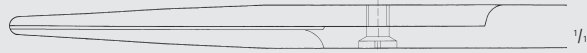

BC250R

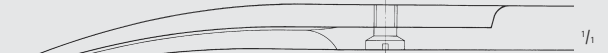

BC251R

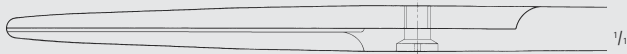

BC252R

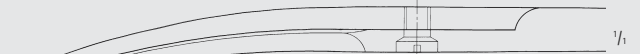

BC253R

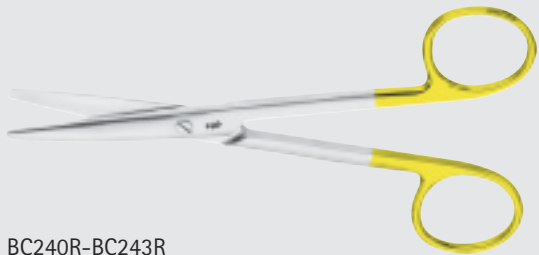

BC240R-BC243R

DUROTIP TC MAYO Dissecting Scissors

Catalog Number	Tip	Blade	Length (in.)
BC240R	B/B	STR	5 1/2
BC241R	B/B	CVD	5 1/2
BC242R	B/B	STR	6 3/4
BC243R	B/B	CVD	6 3/4

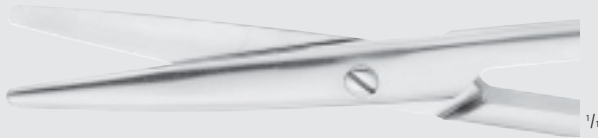

BC240R

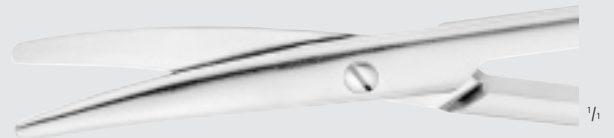

BC241R



BC242R



BC243R

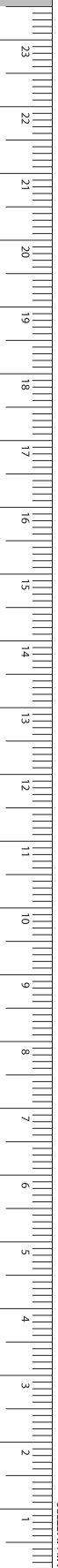

DUROTIP TC MAYO Dissecting Scissors

Catalog Number	Tip	Blade	Length (in.)
BC558R	B/B	STR	9
BC559R	B/B	CVD	9
MB726R	B/B	CVD	14

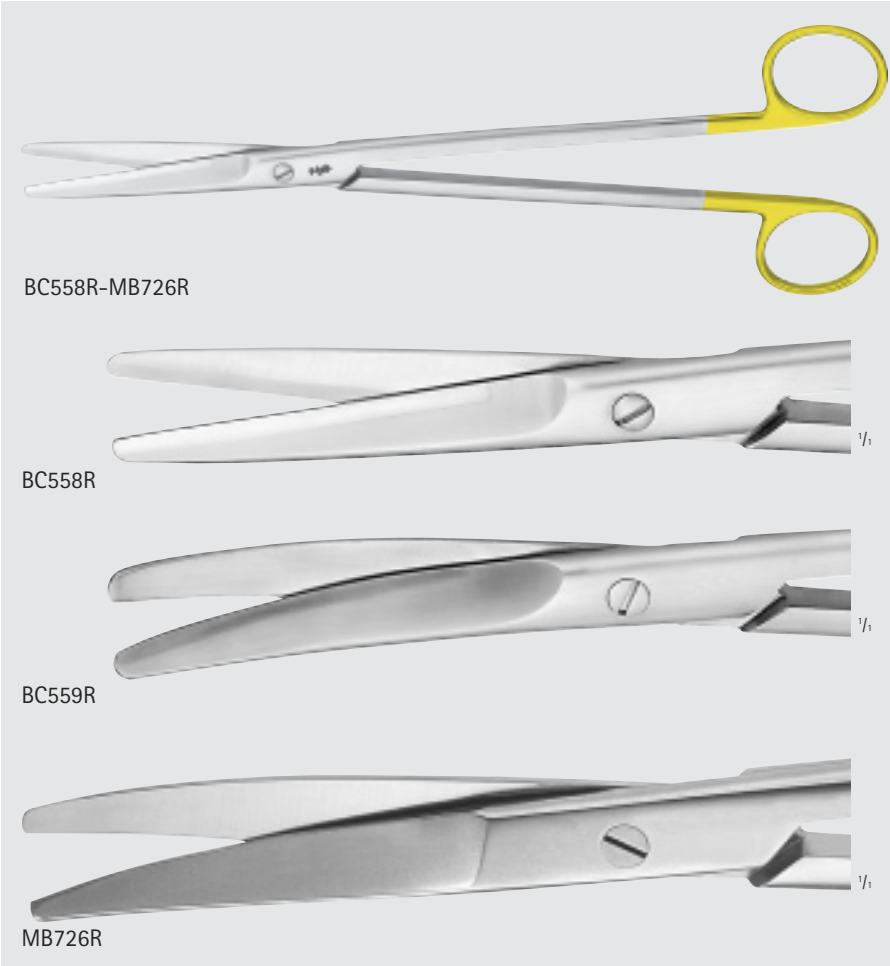

DUROTIP TC Strabismus Scissors

Catalog Number	Tip	Blade	Length (in.)
BC256R	B/B	STR	4 1/2
BC257R	B/B	CVD	4 1/2

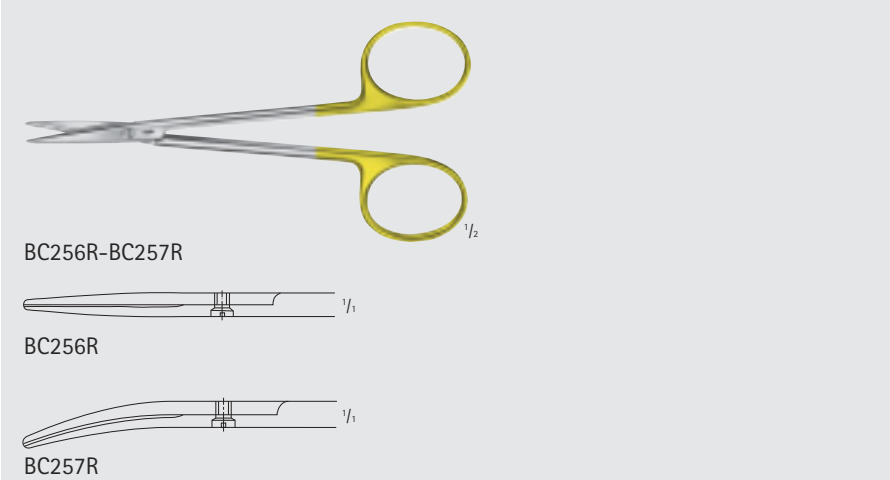

General Surgery
DUROTIP® TC Scissors

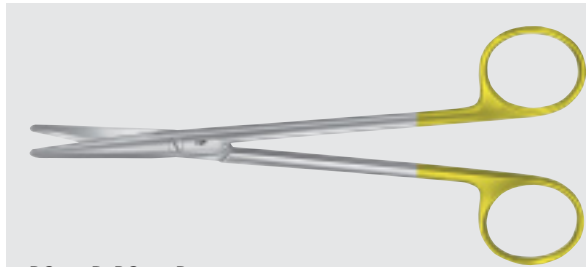
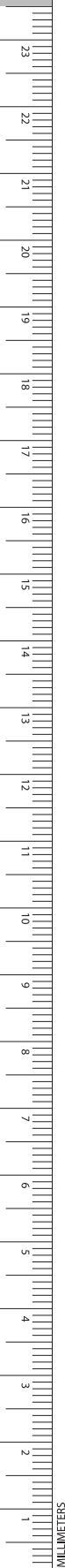

BC260R-BC265R

DUROTIP TC METZENBAUM Dissecting Scissors

Catalog Number	Tip	Blade	Length (in.)
BC260R	B/B	STR	5 3/4
BC261R	B/B	CVD	5 3/4
BC262R	B/B	STR	7
BC263R	B/B	CVD	7
BC265R	B/B	CVD	8

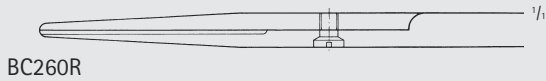

BC260R

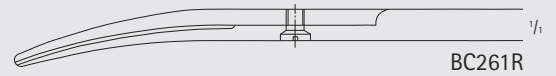

BC261R

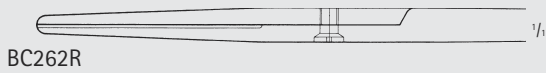

BC262R

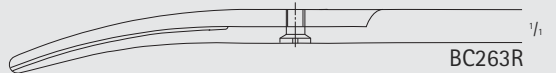

BC263R

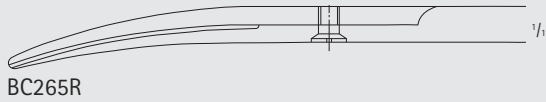

BC265R



MB205R-MB207R

DUROTIP TC METZENBAUM Dissecting Scissors

Catalog Number	Tip	Blade	Length (in.)
MB205R	S/S	STR	9 1/4
MB206R	S/S	CVD	9 1/4
MB207R	S/S	CVD	5 3/4



MB205R



MB206R



MB207R

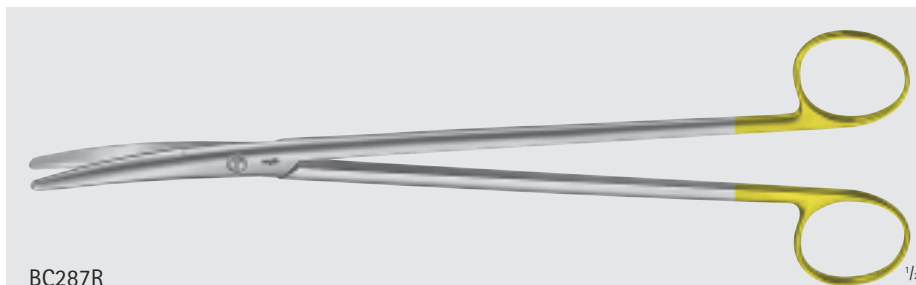

BC287R

DUROTIP TC METZENBAUM Dissecting Scissors

Catalog Number	Tip	Blade	Length (in.)
BC287R	BROAD	CVD	9

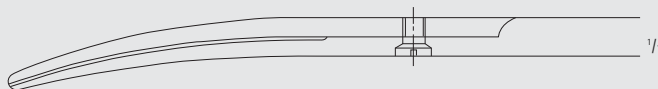

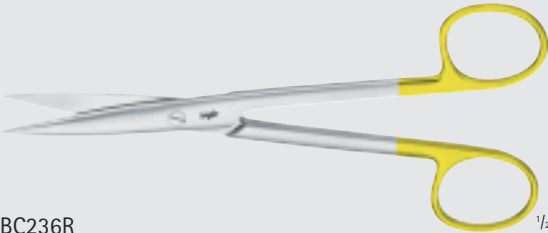

BC236R $\frac{1}{2}$



$\frac{1}{2}$

DUROTIP TC Operating Scissors

Catalog Number	Tip	Blade	Length (in.)
BC236R	S/S	STR	5 3/4

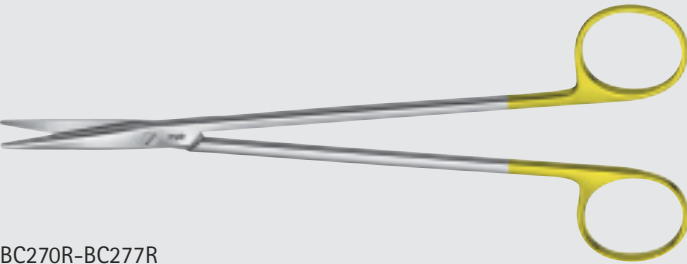

BC270R-BC277R

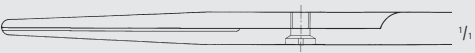

BC270R $\frac{1}{2}$

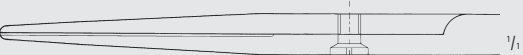

BC274R $\frac{1}{2}$

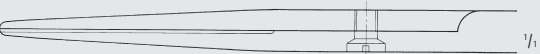

BC276R $\frac{1}{2}$

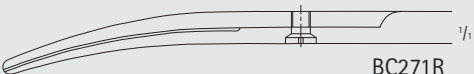

BC271R $\frac{1}{2}$

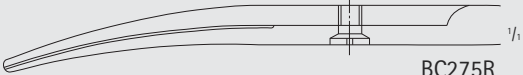

BC275R $\frac{1}{2}$

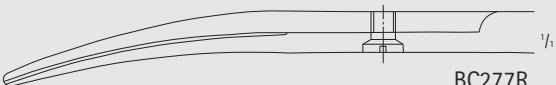

BC277R $\frac{1}{2}$

DUROTIP TC METZENBAUM Dissecting Scissors, Delicate

Catalog Number	Tip	Blade	Length (in.)
BC270R	B/B	CVD	7
BC271R	B/B	CVD	7
BC274R	B/B	STR	8
BC275R	B/B	CVD	8
BC276R	B/B	STR	9
BC277R	B/B	CVD	9

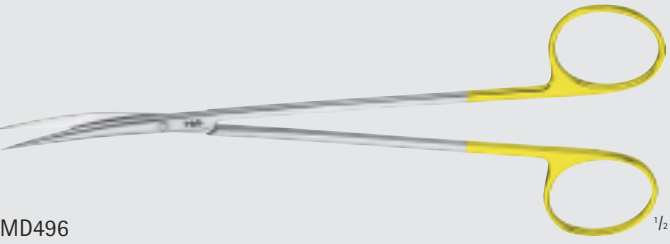

MD496 $\frac{1}{2}$



$\frac{1}{2}$

DUROTIP TC METZENBAUM Dissecting Scissors, Delicate

Catalog Number	Tip	Blade	Length (in.)
MD496	S/S	CVD	7



General Surgery

DUROTIP® TC Scissors

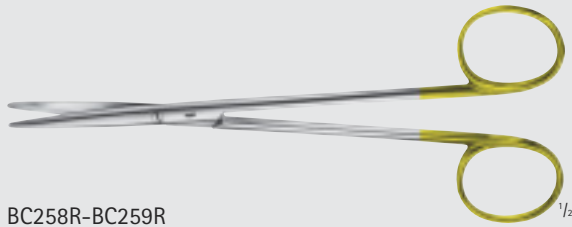
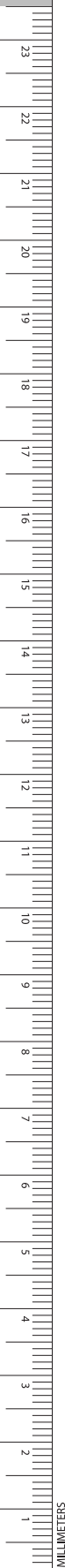

BC258R-BC259R

1/2

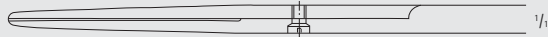

BC258R

1/1



BC259R

1/1

DUROTIP TC BABY-METZENBAUM Dissecting Scissors, Delicate

Catalog Number	Tip	Blade	Length (in.)
BC258R	B/B	STR	5 3/4
BC259R	B/B	CVD	5 3/4

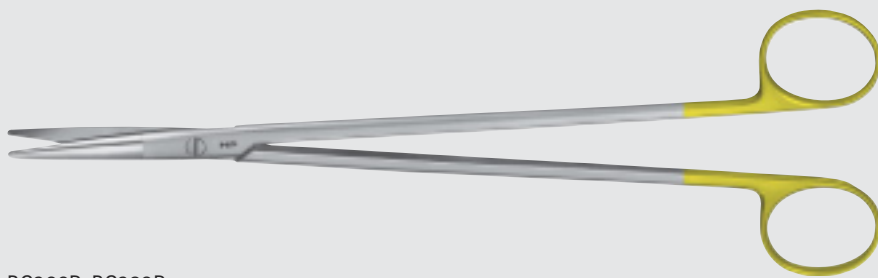

BC266R-BC289R

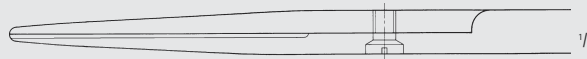

BC266R

1/1

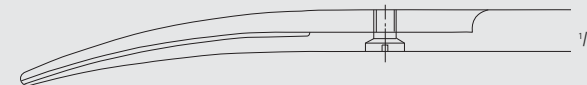

BC267R

1/1

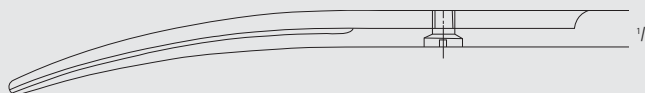

BC279R

1/1

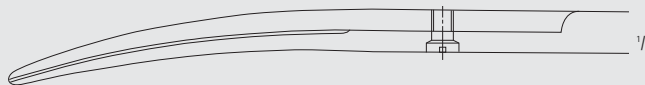

BC281R

1/1

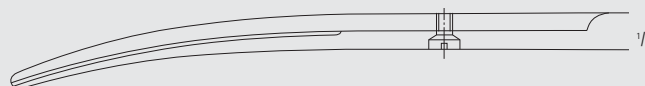

BC282R

1/1

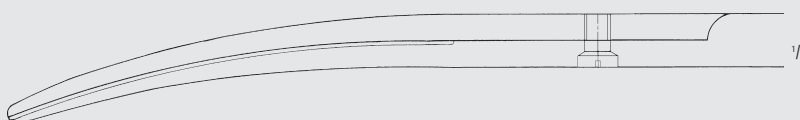

BC289R

1/1

DUROTIP TC NELSON-METZENBAUM Dissecting Scissors

Catalog Number	Tip	Blade	Length (in.)
BC266R	B/B	STR	9
BC267R	B/B	CVD	9
BC279R	B/B	CVD	10 1/4
BC281R	B/B	CVD	11
BC282R	B/B	CVD	11 1/4
BC289R	B/B	CVD	12

DUROTIP TC Dissecting Scissors

Catalog Number	Tip	Blade	Length (in.)
BC285R	B/B	CVD	14

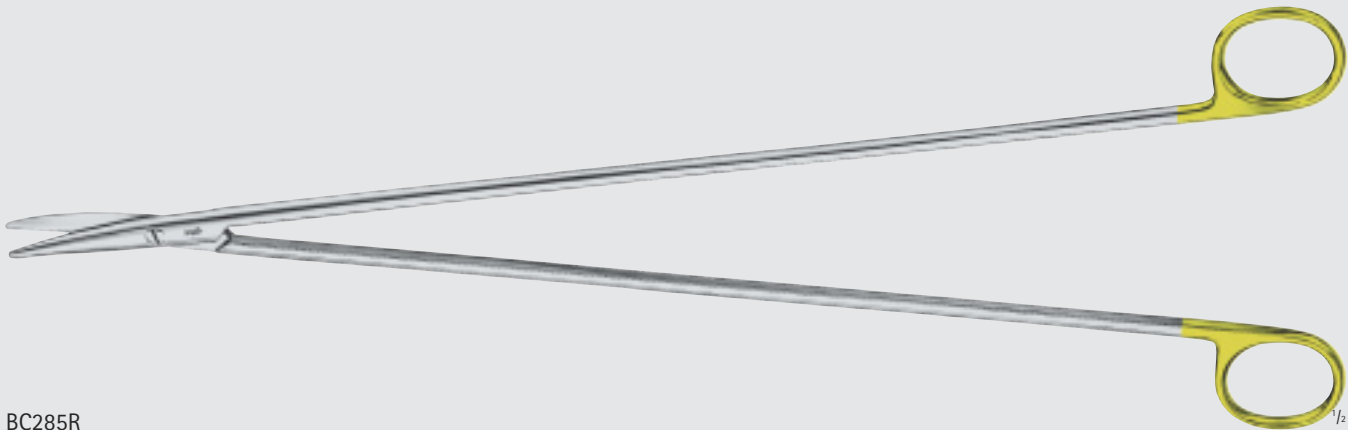

BC285R

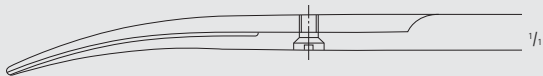

**DUROTIP TC TOENNIS-ADSON
 Dissecting Scissors, Delicate**

Catalog Number	Tip	Blade	Length (in.)
BC273R	B/B	CVD	7

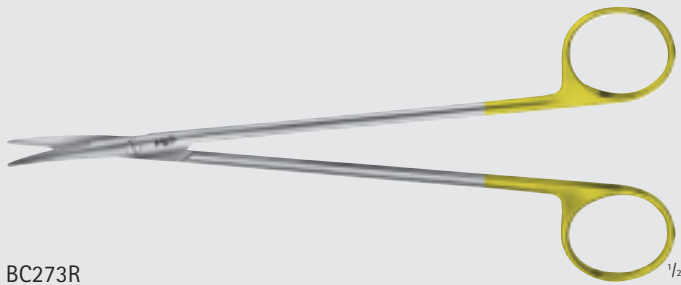

BC273R

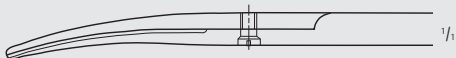

**DUROTIP TC LEXER Dissecting Scissors,
 Delicate**

Catalog Number	Tip	Blade	Length (in.)
BC283R	B/B	CVD	6 1/2

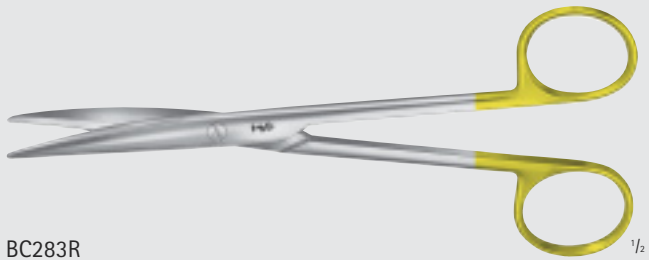

BC283R

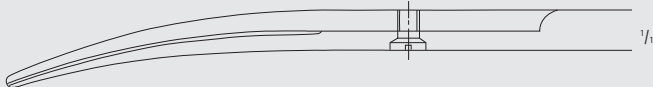

General Surgery

DUROTIP® TC Scissors



Wavecut

Wavecut scissors have one serrated cutting edge to help prevent tissue from slipping. The W after the item number indicates the scissors are the wavecut style, e.g. BC211W.



BC253W

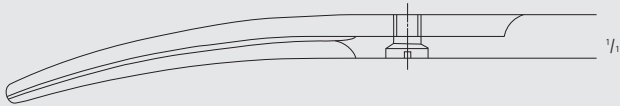

DUROTIP TC MAYO Wavecut Dissecting Scissors

Catalog Number	Tip	Blade	Length (in.)
BC253W	B/B	CVD	6 3/4

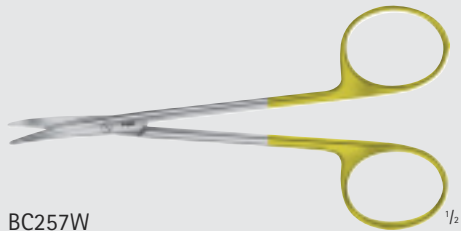

BC257W

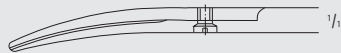

DUROTIP TC Strabismus Wavecut Scissors

Catalog Number	Tip	Blade	Length (in.)
BC257W	B/B	CVD	4 1/2

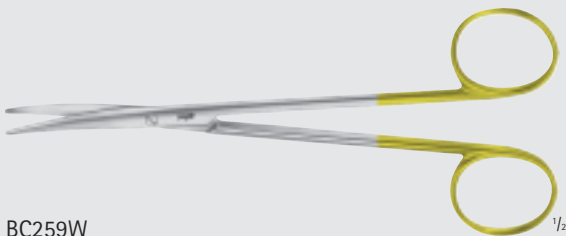

BC259W

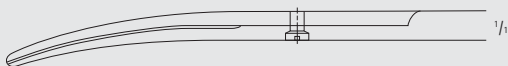

DUROTIP TC BABY-METZENBAUM Wavecut Dissecting Scissors, Delicate

Catalog Number	Tip	Blade	Length (in.)
BC259W	B/B	CVD	5 3/4



DUROTIP TC METZENBAUM Wavecut Dissecting Scissors

Catalog Number	Tip	Blade	Length (in.)
BC261W	B/B	CVD	5 3/4
BC263W	B/B	CVD	7
BC265W	B/B	CVD	8

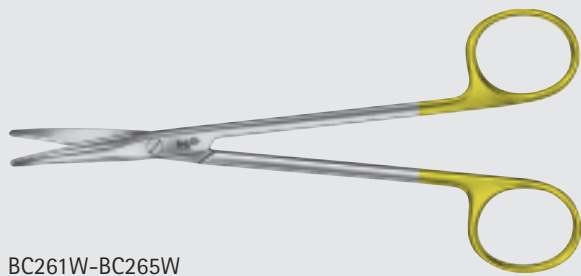

BC261W-BC265W

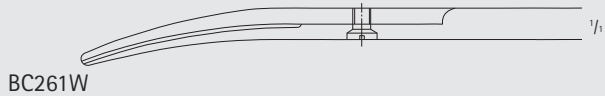

BC261W

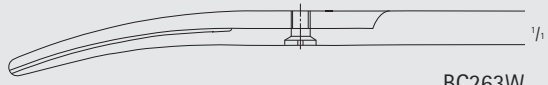

BC263W

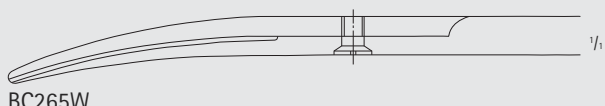

BC265W

DUROTIP TC METZENBAUM Wavecut Dissecting Scissors, Delicate

Catalog Number	Tip	Blade	Length (in.)
BC271W	B/B	CVD	7
BC275W	B/B	CVD	8
BC277W	B/B	CVD	9



BC271W-BC277W

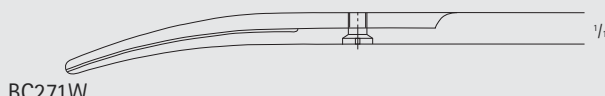

BC271W

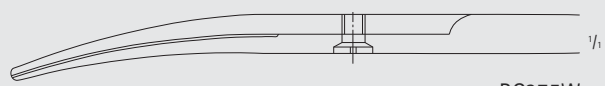

BC275W

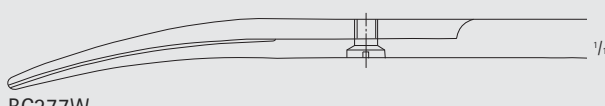

BC277W

DUROTIP TC METZENBAUM Wavecut Dissecting Scissors, Heavy

Catalog Number	Tip	Blade	Length (in.)
BC287W	B/B	CVD	9

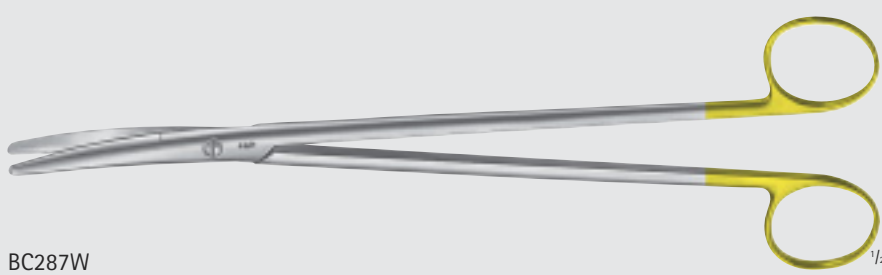

BC287W

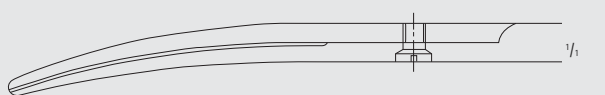

General Surgery
DUROTIP® TC Scissors

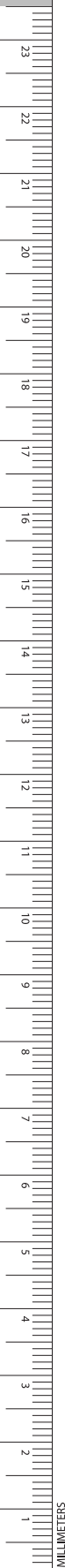

BC273W $\frac{1}{2}$

$\frac{1}{4}$

DUROTIP TC TOENNIS-ADSON Wavecut Dissecting Scissors

Catalog Number	Tip	Blade	Length (in.)
BC273W	B/B	CVD	7

BC267W $\frac{1}{2}$

$\frac{1}{4}$

BC279W-BC281W $\frac{1}{2}$

$\frac{1}{4}$ $\frac{1}{4}$

BC279W BC281W

DUROTIP TC NELSON-METZENBAUM Wavecut Dissecting Scissors

Catalog Number	Tip	Blade	Length (in.)
BC267W	B/B	CVD	9
BC279W	B/B	CVD	10 1/4
BC281W	B/B	CVD	11

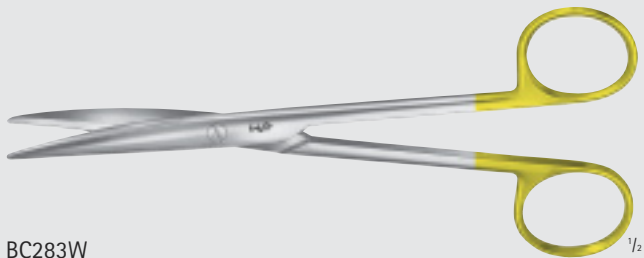

BC283W

1/2

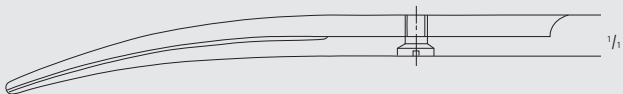

1/1

DUROTIP TC LEXER Dissecting Wavecut Scissors, Delicate

Catalog Number	Tip	Blade	Length (in.)
BC283W	B/B	CVD	6 1/2



BC284W

1/2

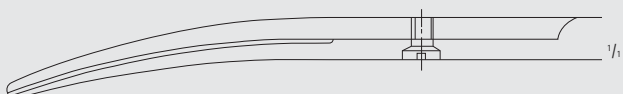

1/1

DUROTIP TC MAYO-LEXER Wavecut Scissors

Catalog Number	Tip	Blade	Length (in.)
BC284W	B/B	CVD	6 1/2



INCHES

General Surgery

DUROTIP® TC Scissors

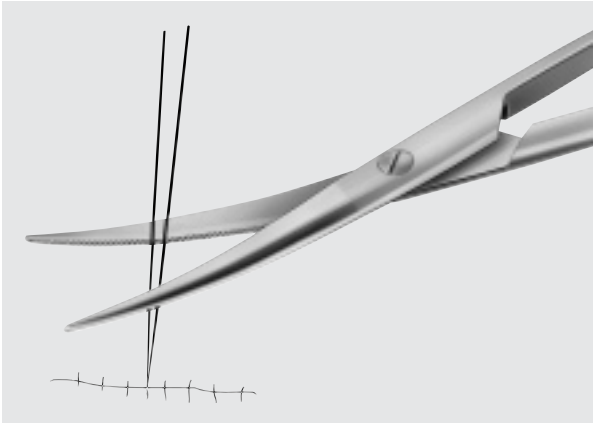

DUROTIP TC Ligature Scissors

- Carbide inserts guarantee permanent sharp cutting edge (also in the distal area of the blades).
- Wavecut prevents suture materials from slipping.
- Identified by 1 goldplated ring.



BC294W-BC298W

DUROTIP TC Ligature Wavecut Scissors

Catalog Number	Tip	Blade	Length (in.)
BC294W	B/B	CVD	5 3/4
BC295W	B/B	CVD	7
BC296W	B/B	CVD	9
BC297W	B/B	CVD	10 1/4
BC298W	B/B	CVD	13 3/4

BC294W

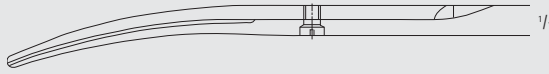

BC295W

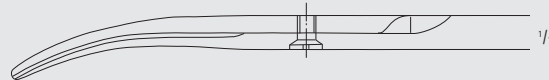

BC296W

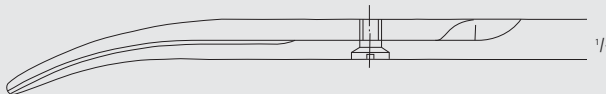

BC297W

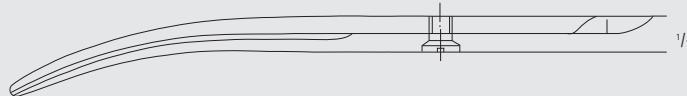

BC298W

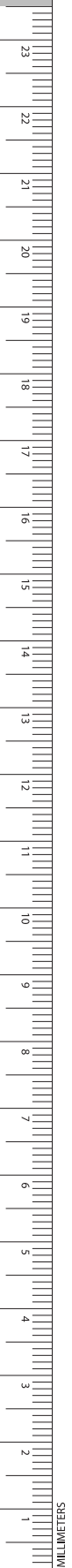
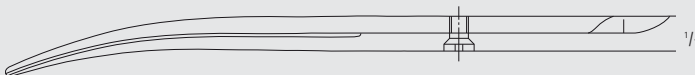

SuperCut Scissors

Your everyday black handle scissors

- Microtome Edge
 - Razor sharp cutting edge facilitates gentle cutting with minimal force
- Wavecut Blade
 - Prevents tissue from slipping out during the cutting process

For more information see our brochure number DOC821



BC900R-BC901R

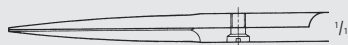

BC900R

SuperCut Iris Scissors, Delicate

Catalog Number	Tip	Blade	Length (in.)
BC900R	S/S	STR	4 3/8
BC901R	S/S	CVD	4 3/8



BC901R

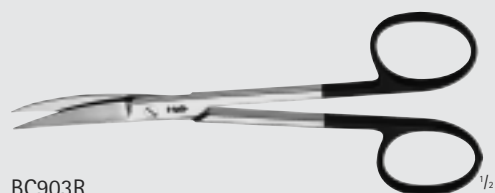

BC903R



SuperCut Scissors, Delicate

Catalog Number	Tip	Blade	Length (in.)
BC903R	S/S	CVD	5



BC904R-BC905R



BC904R

STEVENS SuperCut Scissors, Delicate

Catalog Number	Tip	Blade	Length (in.)
BC904R	B/B	STR	4 1/8
BC905R	B/B	CVD	4 1/8



BC905R

General Surgery

SuperCut Scissors

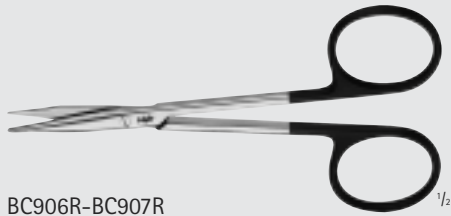
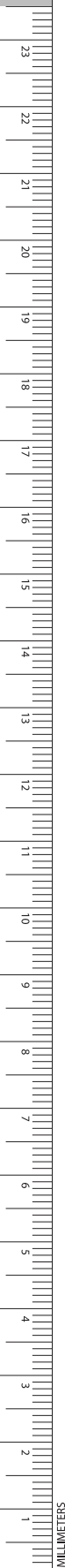

BC906R-BC907R



BC906R

STEVENS SuperCut Scissors, Delicate (continued)

Catalog Number	Tip	Blade	Length (in.)
BC906R	B/B	STR	4 3/8
BC907R	B/B	CVD	4 3/8



BC907R



BC909R



GOLDMAN-FOX SuperCut Scissors, Delicate

Catalog Number	Tip	Blade	Length (in.)
BC909R	S/S	CVD	5 1/8



BC939R



FOMON SuperCut Scissors, Delicate

Catalog Number	Tip	Blade	Length (in.)
BC939R	B/B	CVD	4 1/2

JAMESON SuperCut Scissors, Delicate

Catalog Number	Tip	Blade	Length (in.)
BC911R	B/B	CVD	5 1/8
BC915R	B/B	CVD	6
BC919R	B/B	CVD	7



BC911R

1/2



1/4

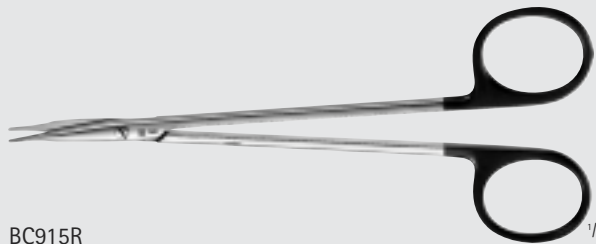

BC915R

1/2



1/4

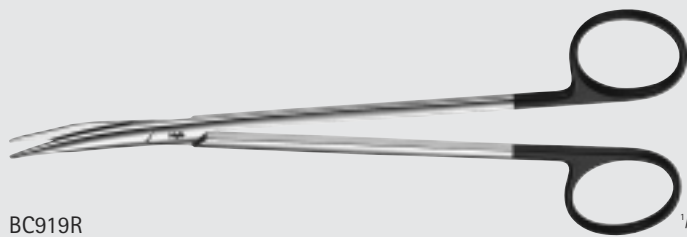

BC919R

1/2



1/4

JOSEPH SuperCut Scissors, Delicate

Catalog Number	Tip	Blade	Length (in.)
BC916R	S/S	STR	6
BC917R	S/S	CVD	6

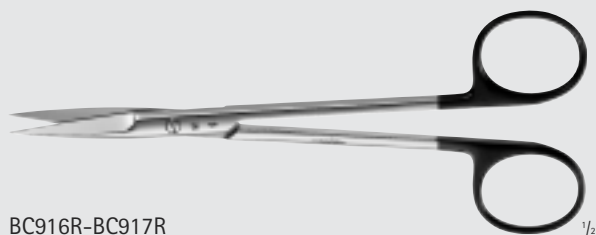

BC916R-BC917R

1/2



BC916R

1/4



BC917R

1/4



INCHES

General Surgery

SuperCut Scissors, Delicate

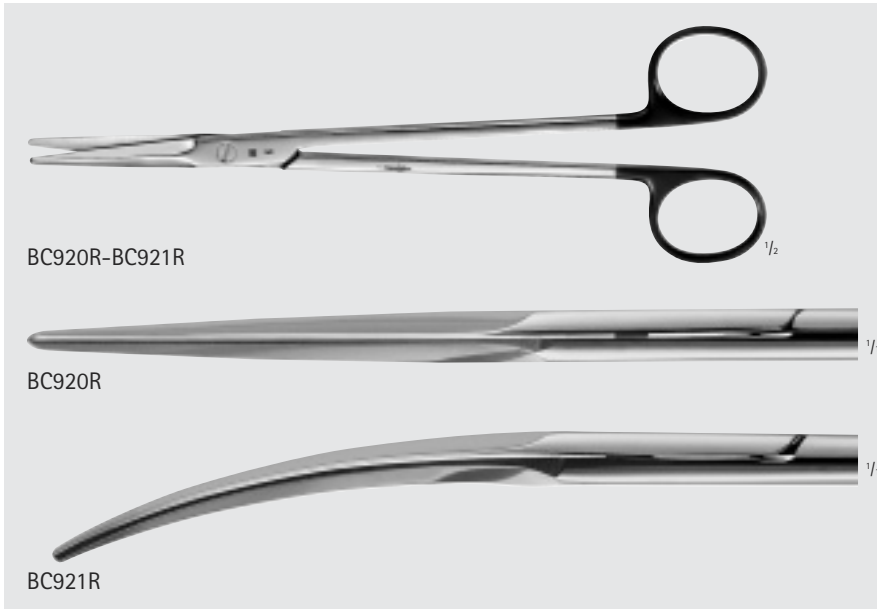
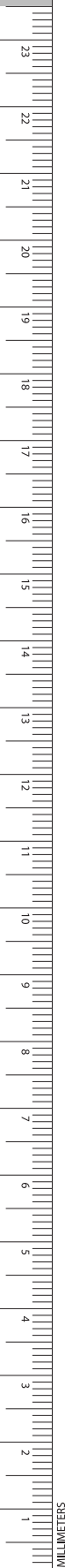

GORNEY SuperCut Scissors, Delicate

Catalog Number	Tip	Blade	Length (in.)
BC920R	B/B	STR	7 3/4
BC921R	B/B	CVD	7 3/4

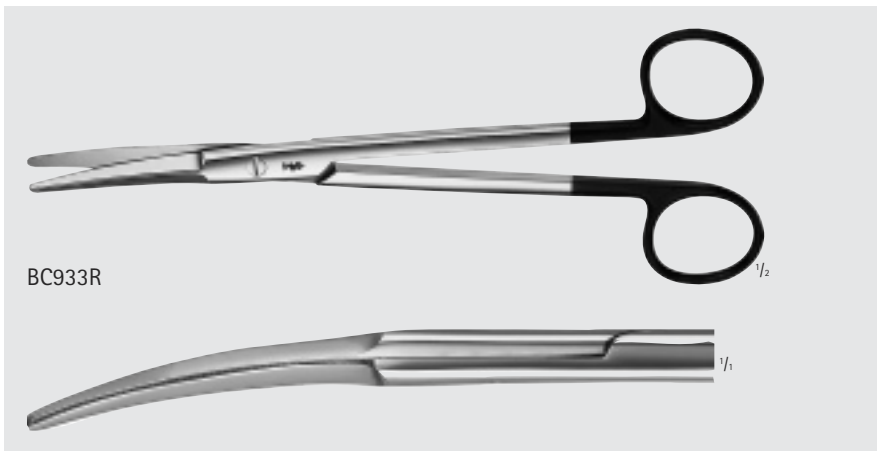

KAYE SuperCut Scissors, Delicate

Catalog Number	Tip	Blade	Length (in.)
BC933R	B/B	CVD	7 3/4

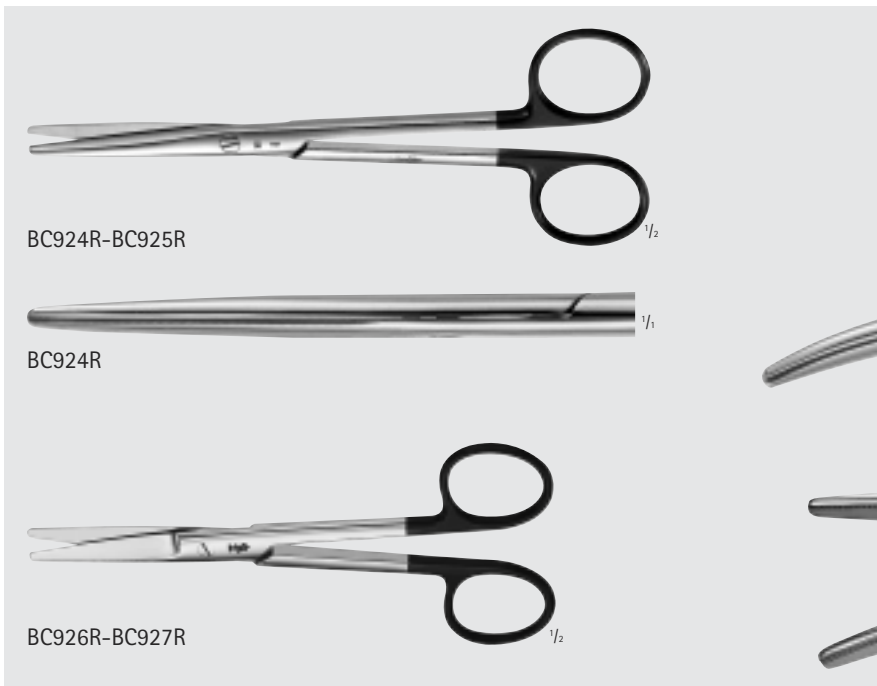

MAYO SuperCut Scissors, Delicate

Catalog Number	Tip	Blade	Length (in.)
BC924R	B/B	CVD	6 1/2
BC925R	B/B	CVD	6 1/2
BC926R	B/B	STR	5 3/4
BC927R	B/B	CVD	5 3/4

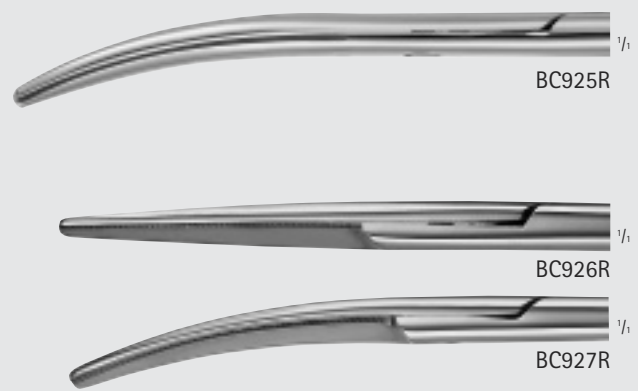



BABY-METZENBAUM SuperCut Scissors, Delicate

Catalog Number	Tip	Blade	Length (in.)
BC930R	B/B	STR	4 1/2
BC931R	B/B	CVD	4 1/2



BC930R-BC931R ^{1/2}



BC930R ^{1/1}



BC931R ^{1/1}

METZENBAUM SuperCut Scissors, Delicate

Catalog Number	Tip	Blade	Length (in.)
BC934R	B/B	STR	5 3/4
BC935R	B/B	CVD	5 3/4

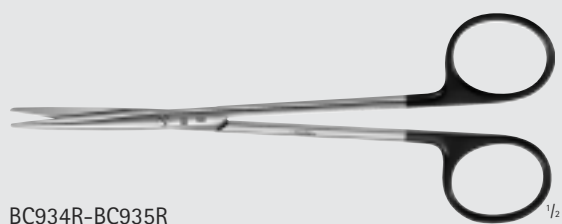

BC934R-BC935R ^{1/2}



BC934R ^{1/1}



BC935R ^{1/1}

METZENBAUM SuperCut Scissors, Delicate

Catalog Number	Tip	Blade	Length (in.)
BC936R	B/B	STR	7
BC937R	B/B	CVD	7

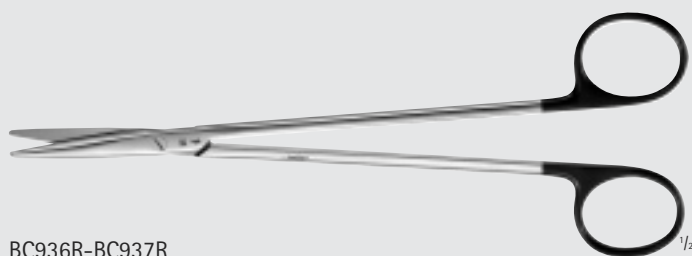

BC936R-BC937R ^{1/2}



BC936R ^{1/1}



BC937R ^{1/1}

General Surgery

SuperCut Scissors

MAYO SuperCut Scissors

Catalog Number	Tip	Blade	Length (in.)
BC922R	B/B	STR	10
BC929R	B/B	CVD	11
BC938R	B/B	STR	12

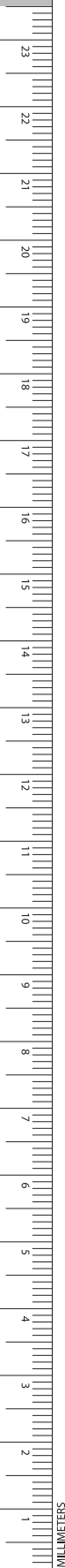
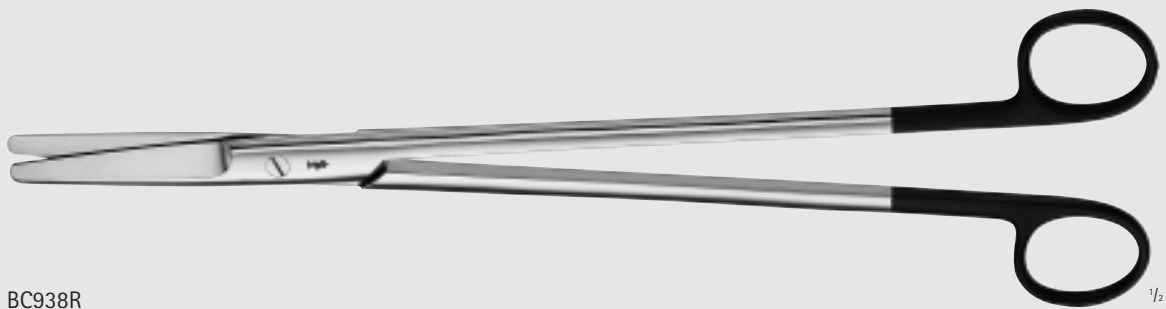
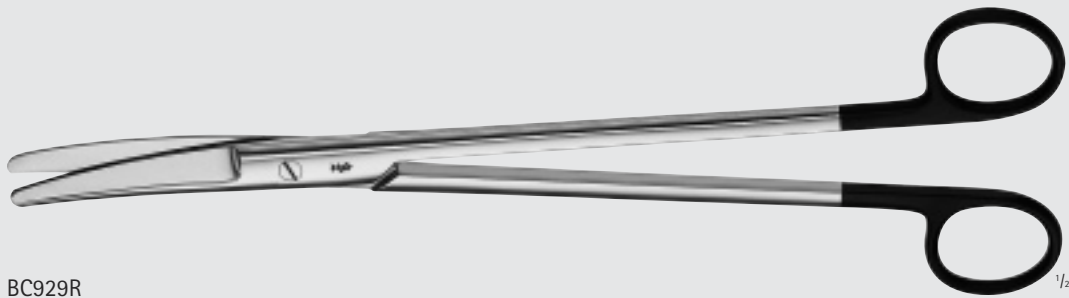
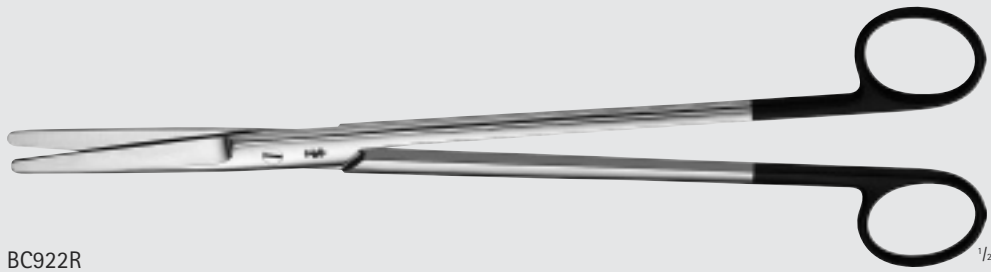



METZENBAUM SuperCut Scissors,
Delicate

Catalog Number	Tip	Blade	Length (in.)
BC945R	B/B	CVD	9
BC947R	B/B	CVD	10 1/4
BC949R	B/B	CVD	11 1/4
BC951R	B/B	CVD	12
BC953R	B/B	CVD	14

BC945R-BC953R



BC945R



BC947R



BC949R



BC951R



BC953R



General Surgery

SuperCut Scissors

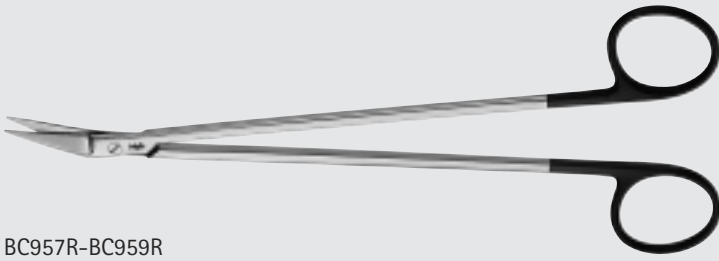

BC957R-BC959R



BC957R



BC958R



BC959R

POTTS-SMITH SuperCut Scissors, Delicate

Catalog Number	Tip	Blade	Length (in.)
BC957R	B/B	25°	7 1/2
BC958R	B/B	45°	7 1/4
BC959R	B/B	60°	7

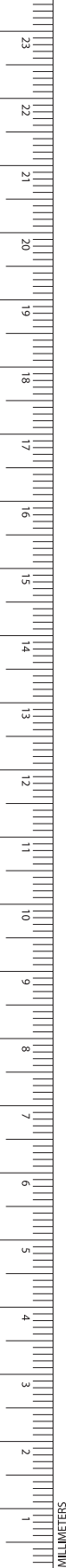

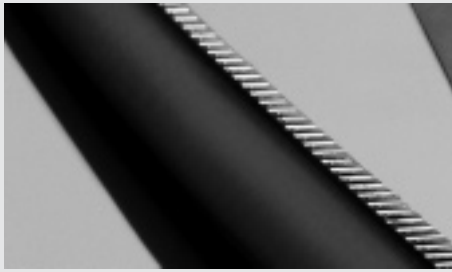

Noir Supreme Cut Scissors

- **Noir**
The combination of the renowned Aesculap tungsten carbide technology with the Aesculap Noir coating results in an extremely high surface hardness and therefore high wear resistance in daily hospital use.
- **Microtome edge**
The extremely sharp cutting edge of the scissors blade facilitates gentle cutting of tissue with minimal use of force.
- **Wavecut** helps prevent tissue from slipping out during the cutting process.
- The WB after the item number indicates the Noir scissors are the wavecut style, e.g. BC211WB.

For more information see our brochure number DOC637.



BC210B-BC211WB



BC210B

Noir Iris Dissecting Scissors

Catalog Number	Tip	Blade	Length (in.)
BC210B	S/S	STR	4 3/8
BC211B	S/S	CVD	4 3/8
BC211WB	S/S	CVD	4 3/8



BC211B, BC211WB



BC257B-BC257WB



BC257B

Noir Strabismus Dissecting Scissors

Catalog Number	Tip	Blade	Length (in.)
BC257B	B/B	CVD	4 1/2
BC257WB	B/B	CVD	4 1/2

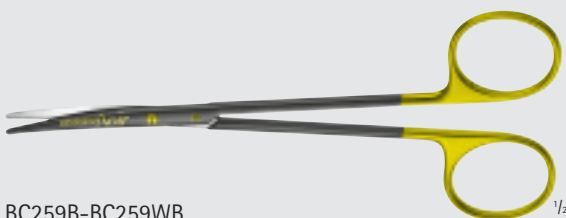

BC259B-BC259WB



BC259B

Noir BABY-METZENBAUM Dissecting Scissors

Catalog Number	Tip	Blade	Length (in.)
BC259B	B/B	CVD	5 3/4
BC259WB	B/B	CVD	5 3/4



General Surgery

Noir Supreme Cut Scissors

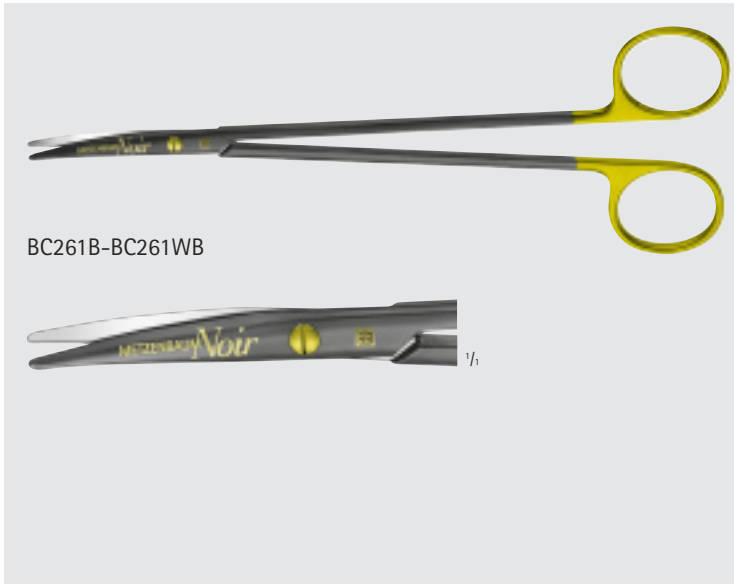
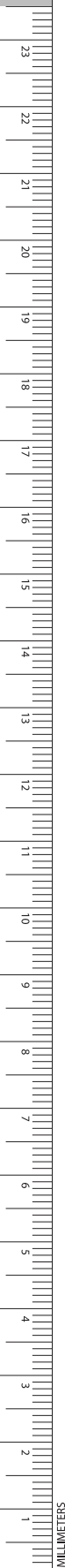

Noir METZENBAUM Dissecting Scissors

Catalog Number	Tip	Blade	Length (in.)
BC261B	B/B	CVD	5 3/4
BC261WB	B/B	CVD	5 3/4

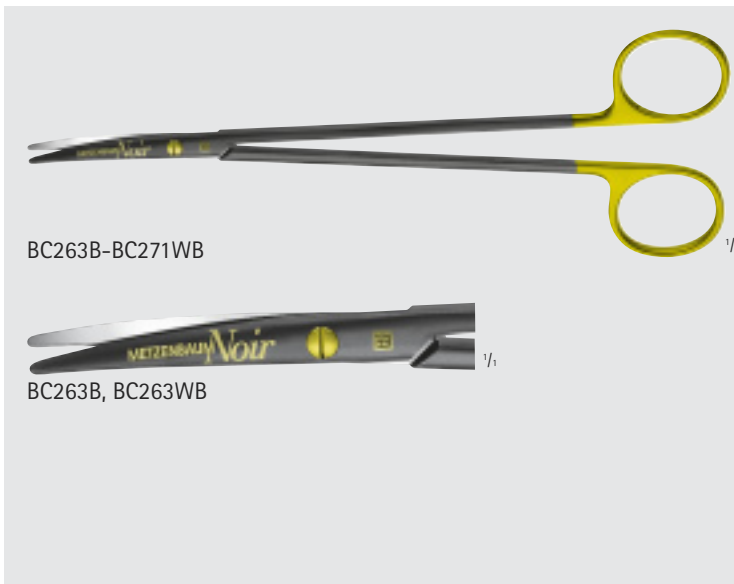

Noir METZENBAUM Dissecting Scissors

Catalog Number	Tip	Blade	Length (in.)
BC263B	B/B	CVD	7
BC263WB	B/B	CVD	7
BC271B	B/B	DEL, CVD	7
BC271WB	B/B	DEL, CVD	7

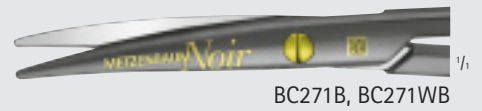

Noir TOENNIS-ADSON Dissecting Scissors

Catalog Number	Tip	Blade	Length (in.)
BC273B	B/B	DEL, CVD	7
BC273WB	B/B	DEL, CVD	7

General Surgery

Noir Supreme Cut Scissors

GENL



Noir METZENBAUM Dissecting Scissors

Catalog Number	Tip	Blade	Length (in.)
BC265B	B/B	CVD	8
BC265WB	B/B	CVD	8
BC275B	B/B	DEL, CVD	8
BC275WB	B/B	DEL, CVD	8

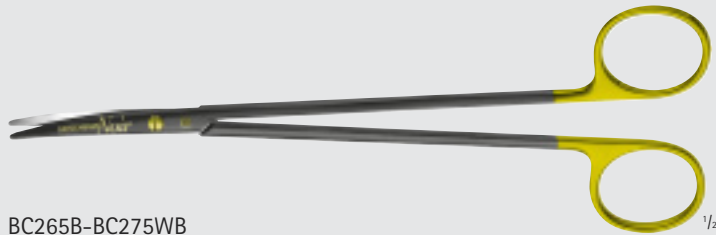

BC265B-BC275WB



BC265B, BC275WB



BC265WB, BC275B

Noir MAYO Dissecting Scissors

Catalog Number	Tip	Blade	Length (in.)
BC252B	B/B	STR	6 3/4
BC253B	B/B	CVD	6 3/4
BC253WB	B/B	CVD	6 3/4



BC252B-BC253WB



BC252B



BC253B, BC253WB

Noir MAYO-LEXER Dissecting Scissors

Catalog Number	Tip	Blade	Length (in.)
BC284B	B/B	CVD	6 1/2
BC284WB	B/B	CVD	6 1/2



BC284B-BC284WB



Noir LEXER Dissecting Scissors

Catalog Number	Tip	Blade	Length (in.)
BC283B	B/B	DEL, CVD	6 1/2
BC283WB	B/B	DEL, CVD	6 1/2

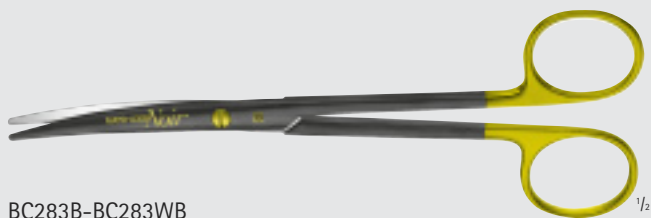

BC283B-BC283WB



General Surgery

Noir Supreme Cut Scissors



Noir METZENBAUM Dissecting Scissors

Catalog Number	Tip	Blade	Length (in.)
BC267B	B/B	CVD	9
BC267WB	B/B	CVD	9
BC277B	B/B	DEL, CVD	9
BC277WB	B/B	DEL, CVD	9

BC267B-BC277WB

BC267B, BC267WB

BC277B, BC277WB

Noir NELSON-METZENBAUM Dissecting Scissors

Catalog Number	Tip	Blade	Length (in.)
BC279B	B/B	DEL, CVD	10 1/4
BC279WB	B/B	DEL, CVD	10 1/4

BC279B-BC279WB

1/4

Noir NELSON-METZENBAUM Dissecting Scissors

Catalog Number	Tip	Blade	Length (in.)
BC281B	B/B	DEL, CVD	11
BC281WB	B/B	DEL, CVD	11

BC281B-BC281WB

1/4

CONVERSE Needle Holders

Catalog Number	Jaw	Length (in.)
BM200R	LONG GROOVES	5 1/8"



BM200R



HALSEY Needle Holder

Catalog Number	Tip	Jaw	Length (in.)
BM201R	DEL	SMOOTH	5 1/8
BM205R	DEL	SERR	5 1/8



BM201R-BM205R

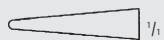

BM201R



BM205R

WEBSTER Needle Holder

Catalog Number	Jaw	Length (in.)
BM202R	SMOOTH	5

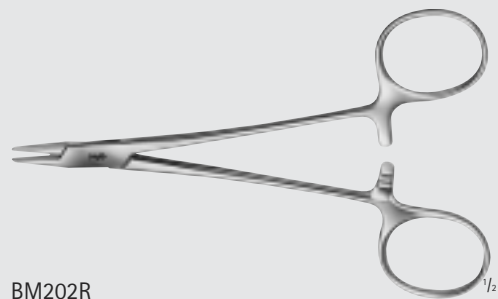

BM202R

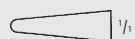

DERF Needle Holder

Catalog Number	Jaw	Length (in.)
BM204R	SERR	5

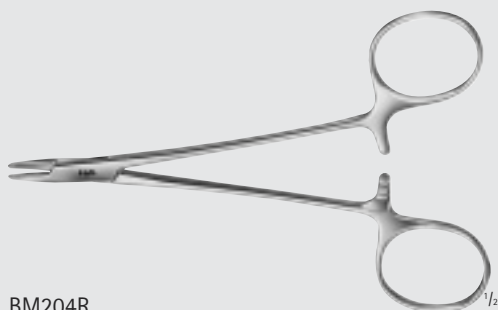

BM204R



INCHES

General Surgery

Needle Holders

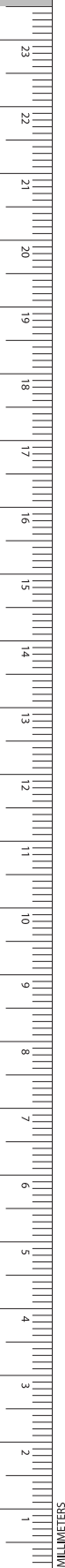

BM210R



DOYEN Needle Holder

Catalog Number	Jaw	Length (in.)
BM210R	SERR	5



BM215R



BAUMGARTNER Needle Holder

Catalog Number	Jaw	Length (in.)
BM215R	SERR	5 3/4

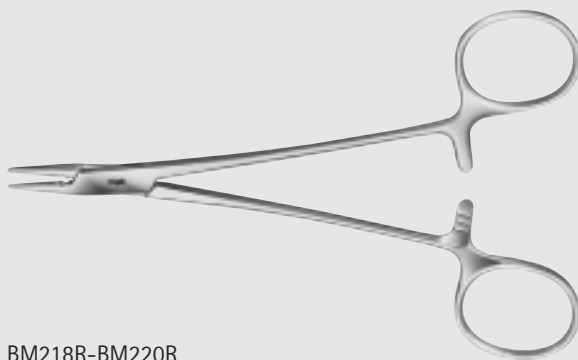

BM218R-BM220R



BM218R



BM220R

CRILE-WOOD Needle Holder

Catalog Number	Jaw	Length (in.)
BM218R	SERR	6
BM220R	SERR	6 1/4

CRILE-MURRAY Needle Holder

Catalog Number	Jaw	Length (in.)
BM219R	SERR	6

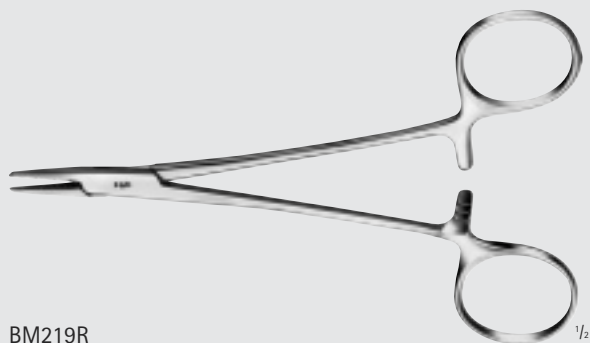

BM219R



ADSON Needle Holder

Catalog Number	Jaw	Length (in.)
BM224R	FEN-SERR	7

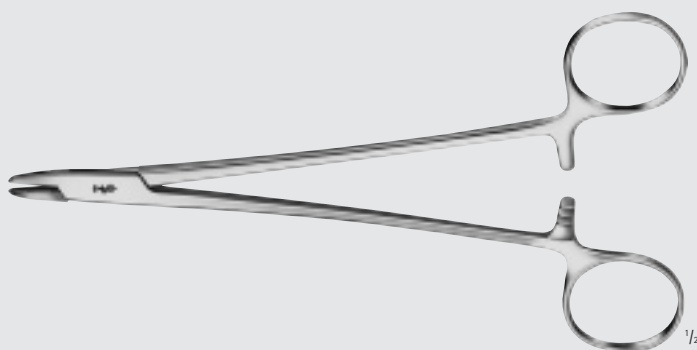

MAYO-HEGAR Needle Holder

Catalog Number	Jaw	Length (in.)
BM235R	SERR	6
BM236R	SERR	7 1/4
BM237R	SERR	8

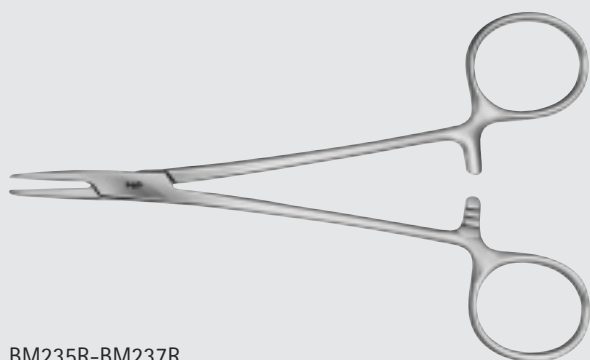

BM235R-BM237R



BM235R



BM236R



BM237R

General Surgery

Needle Holders



BM245R-BM255R



BM245R



BM247R



BM249R



BM255R

HEGAR Needle Holder

Catalog Number	Tip	Jaw	Length (in.)
BM245R	HVY	SERR	6
BM247R	HVY	SERR	7
BM249R	HVY	SERR	8
BM255R	HVY	SERR	8

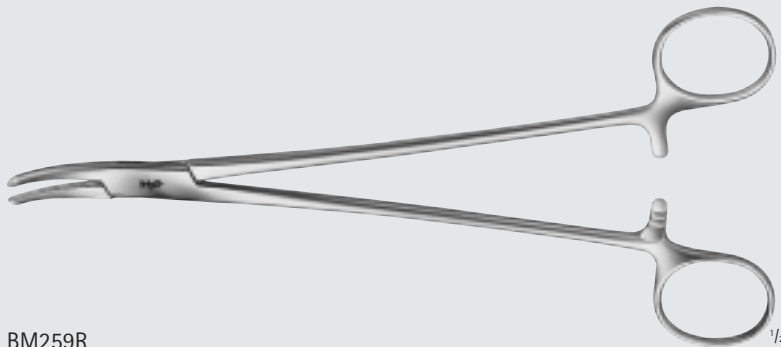

BM259R

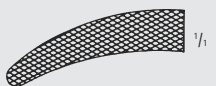

HEANEY Needle Holder

Catalog Number	Jaw	Length (in.)
BM259R	SERR	8

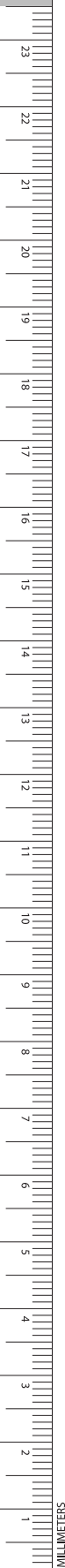

JAMESON Needle Holder

Catalog Number	Tip	Jaw	Length (in.)
BM270R	DEL	SERR	9

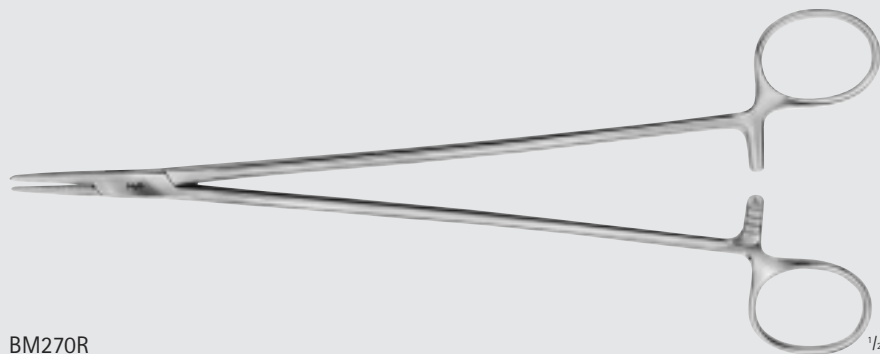

BM270R



WANGENSTEEN Needle Holder

Catalog Number	Jaw	Length (in.)
BM272R	SERR	10 3/4

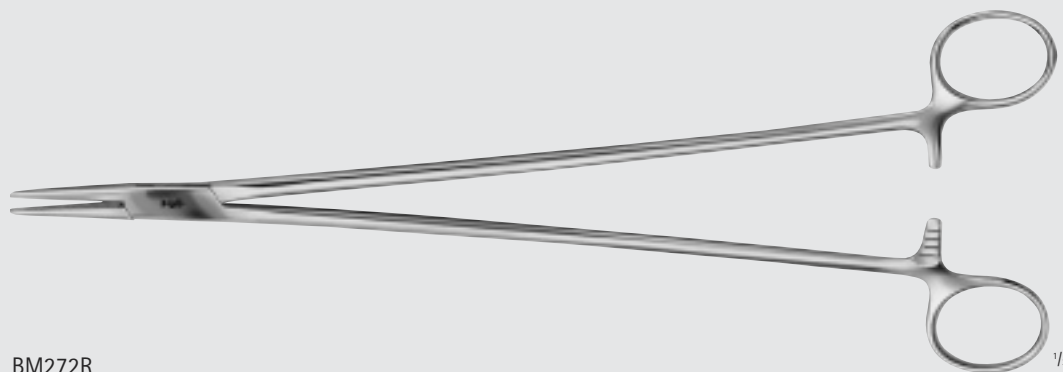

BM272R



MASSON Needle Holder

Catalog Number	Jaw	Length (in.)
BM275R	SERR	10 1/2

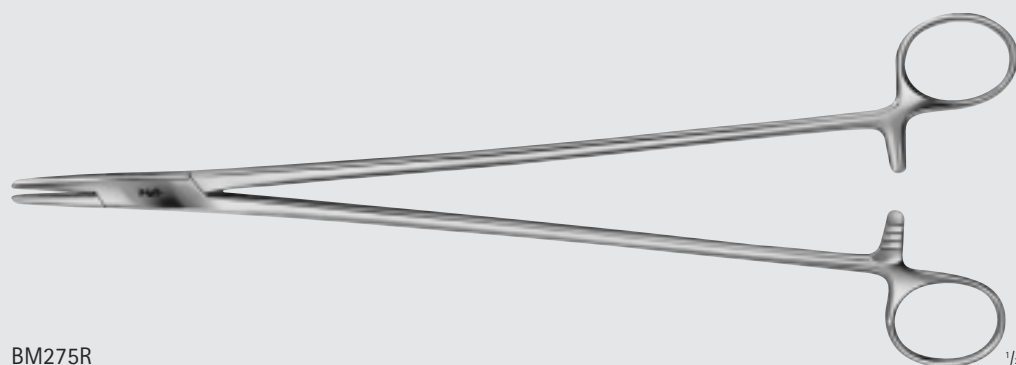

BM275R



General Surgery

Needle Holders

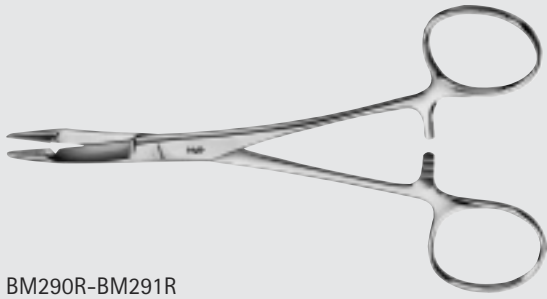

BM290R-BM291R

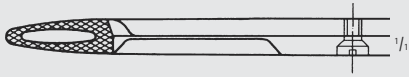
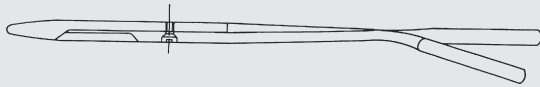

BM290R

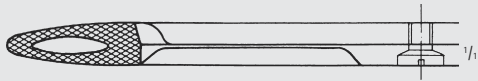

BM291R

HEGAR-OLSEN Needle Holder/Scissors

Catalog Number	Jaw	Length (in.)
BM290R	SERR	5 1/2
BM291R	SERR	7 1/4



BM299R

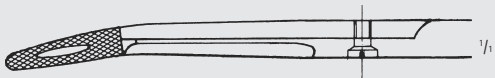
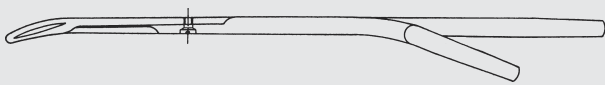

GILLIES Needle Holder/Scissors

Catalog Number	Jaw	Length (in.)
BM299R	SERR	6 1/4

General Surgery

DUROGRIP® TC Needle Holders

GENL

Aesculap features Needle Holders with Tungsten Carbide (TC) inserts. A smooth jaw and three different serration patterns are available, depending on the size of the suture needle.

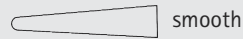
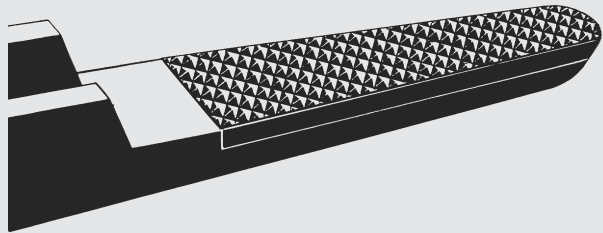

We recommend carbide inserts

with smooth jaw surface for suture material

9/0 - 11/0

with 0.2 mm pitch of serration for suture material

6/0 - 10/0

0.4 mm

4/0 - 6/0

0.5 mm

up to 3/0



DUROGRIP TC CASTROVIEJO Micro Needle Holder

Catalog Number	Jaw	Length (in.)
BM001R	SMOOTH	5 3/4
BM002R	SERR	5 3/4
BM004R	SERR	7
BM005R	SERR	8 1/2



INCHES

General Surgery

DUROGRIP® TC Needle Holder

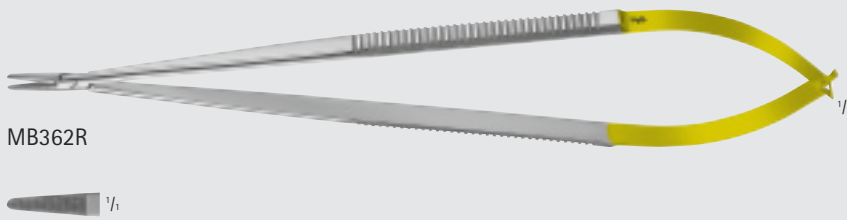

DUROGRIP TC JACOBSON Micro Needle Holder

Catalog Number	Jaw	Length (in.)
MB362R	STR	8 3/4

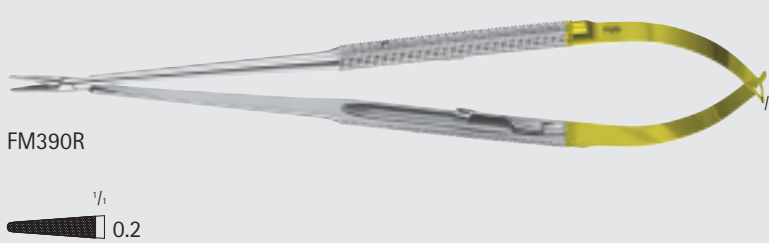

DUROGRIP TC Micro Needle Holder, Round Handle W/Catch

Catalog Number	Tip	Length (in.)
FM390R	STR	8

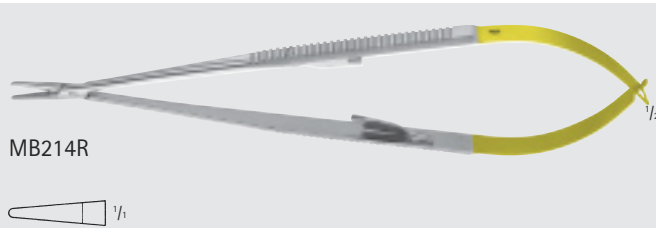

DUROGRIP TC Micro Needle Holder

Catalog Number	Jaw	Length (in.)
MB214R	SMOOTH	7 1/4

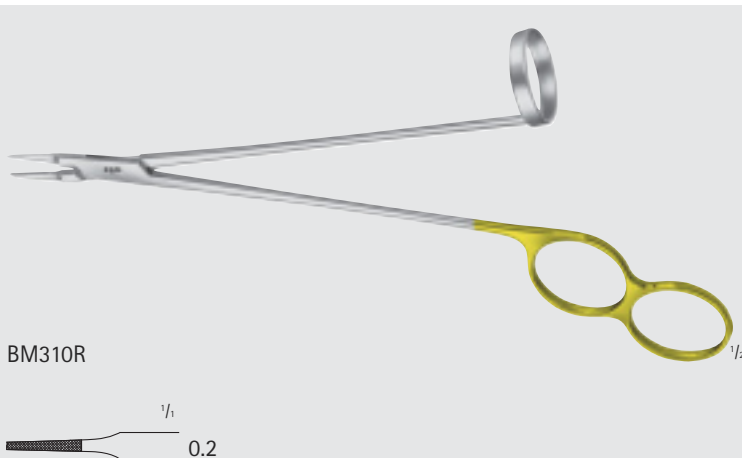

DUROGRIP TC REIN-KUPKA Needle Holder W/Ergonomic Handle

Catalog Number	Tip	Jaw	Length (in.)
BM310R	DEL	SERR	7 1/2

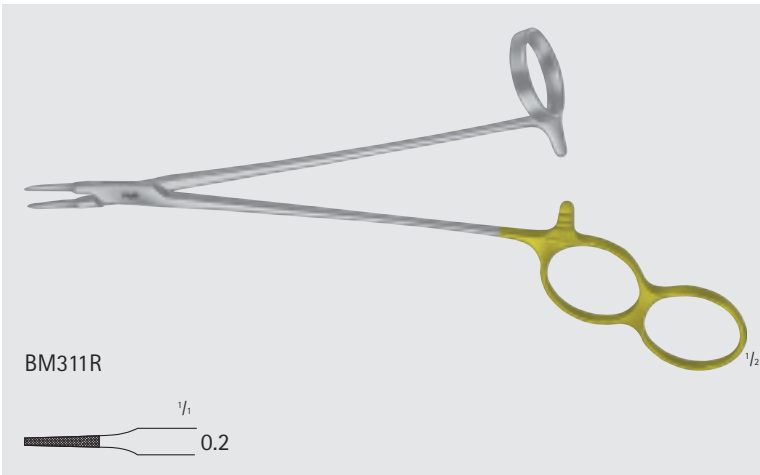

DUROGRIP TC REIN-KUPKA Needle Holder W/Ergonomic Handle (Ratchet)

Catalog Number	Tip	Jaw	Length (in.)
BM311R	DEL	SERR	7 1/2

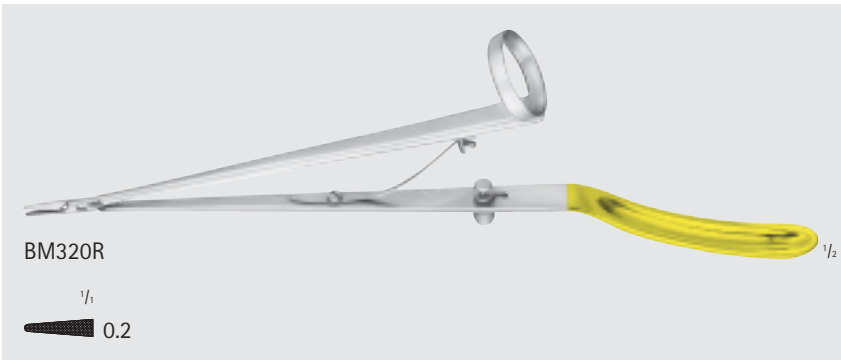

DUROGRIP TC HELLBERG-KUPKA Needle Holder W/Ergonomic Handle

Catalog Number	Jaw	Length (in.)
BM320R	SERR	8 1/4



DUROGRIP TC DERF Needle Holder

Catalog Number	Jaw	Length (in.)
BM008R	SERR	4 1/2

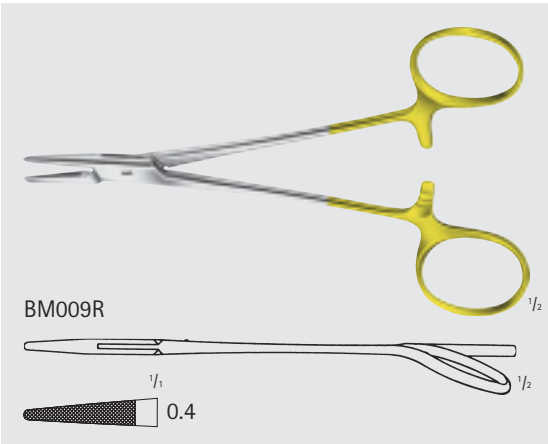

DUROGRIP TC MASING Needle Holder

Catalog Number	Jaw	Length (in.)
BM009R	SERR	5 1/8



General Surgery

DUROGRIP® TC Needle Holders

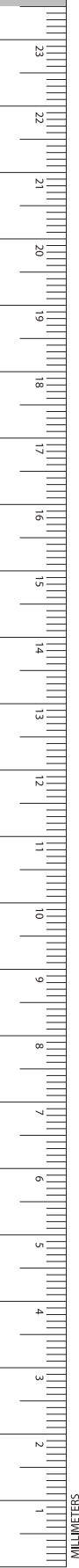

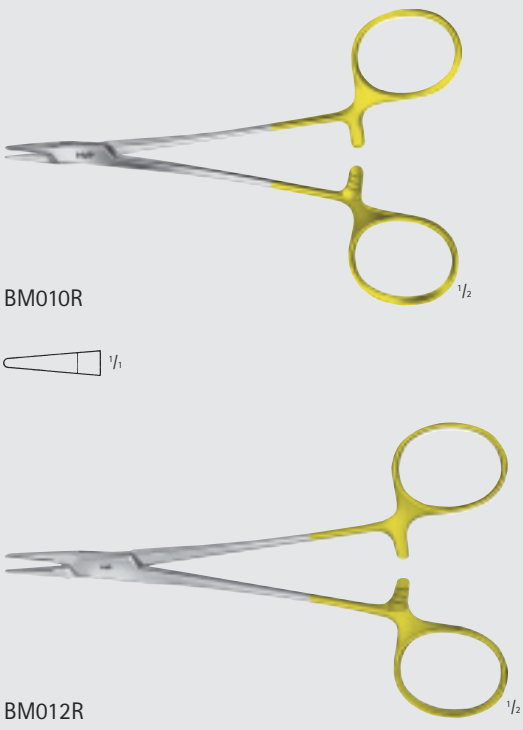

BM010R $\frac{1}{2}$

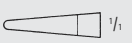

$\frac{1}{4}$

BM012R $\frac{1}{2}$



$\frac{1}{4}$ 0.4

DUROGRIP TC HALSEY Needle Holder

Catalog Number	Jaw	Length (in.)
BM010R	SMOOTH	4 3/4
BM012R	SERR	5 1/8

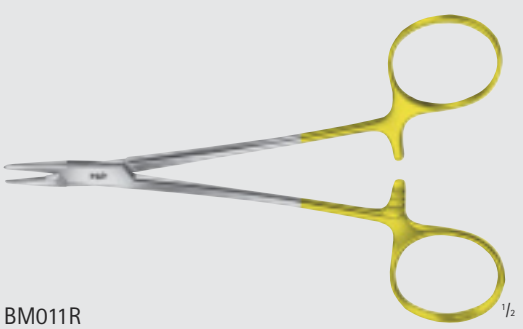

BM011R $\frac{1}{2}$



$\frac{1}{4}$ 0.2

DUROGRIP TC CONVERSE Needle Holder

Catalog Number	Jaw	Length (in.)
BM011R	SERR	5 1/8



BM013R $\frac{1}{2}$



$\frac{1}{4}$ 0.4

DUROGRIP TC BABY-CRILE-WOOD Needle Holder

Catalog Number	Jaw	Length (in.)
BM013R	SERR	6

DUROGRIP TC WEBSTER Needle Holder

Catalog Number	Jaw	Length (in.)
BM014R	SMOOTH	5
BM024R	SERR	5

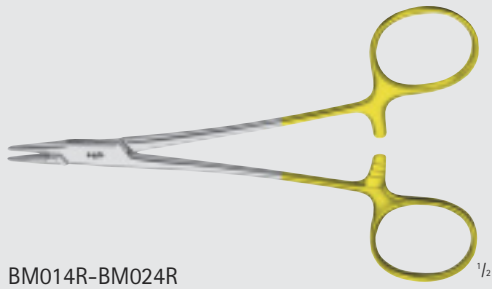

BM014R-BM024R



BM014R

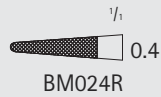

BM024R

DUROGRIP TC BAUMGARTNER Needle Holder

Catalog Number	Jaw	Length (in.)
BM015R	SERR	5 3/4

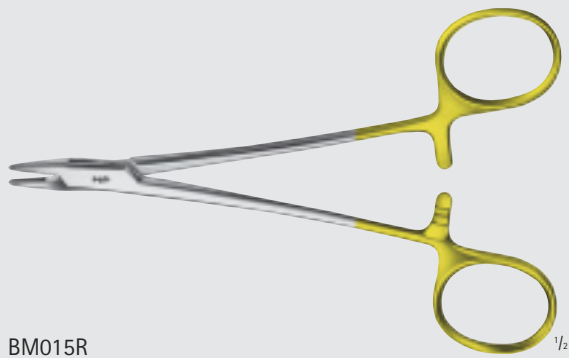

BM015R



BM015R

DUROGRIP TC SAROT Needle Holder

Catalog Number	Jaw	Length (in.)
BM020R	SERR	7
BM023R	SERR	10 1/4

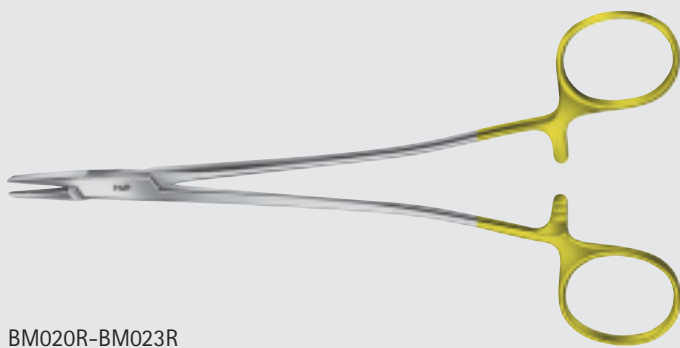

BM020R-BM023R



BM020R



BM023R



INCHES

General Surgery

DUROGRIP® TC Needle Holders

DUROGRIP TC CRILE-WOOD Needle Holder

Catalog Number	Jaw	Length (in.)
BM016R	SERR	5 3/4
BM017R	SERR	7 1/4
BM019R	SERR	8
BM021R	SERR	12
MB604R	SERR	14
BM029R	SMOOTH	6
BM030R	SERR	10 3/4

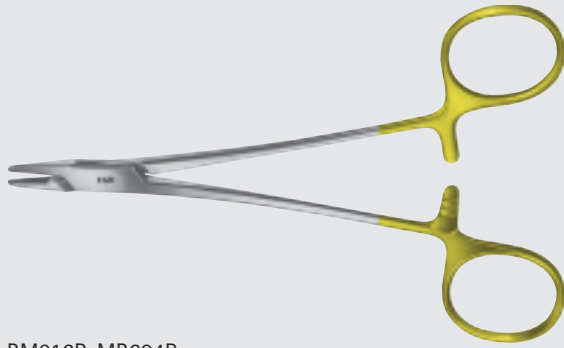

BM016R-MB604R



BM016R



BM017R



BM019R



BM021R



MB604R

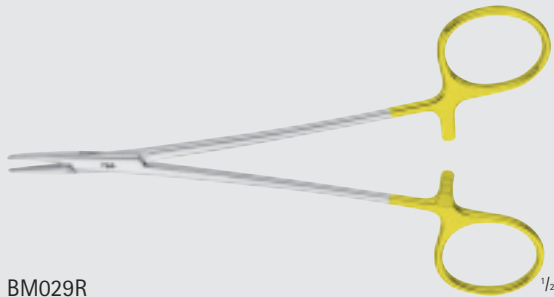

BM029R



BM030R



BM030R

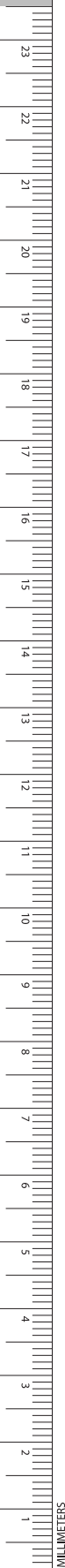

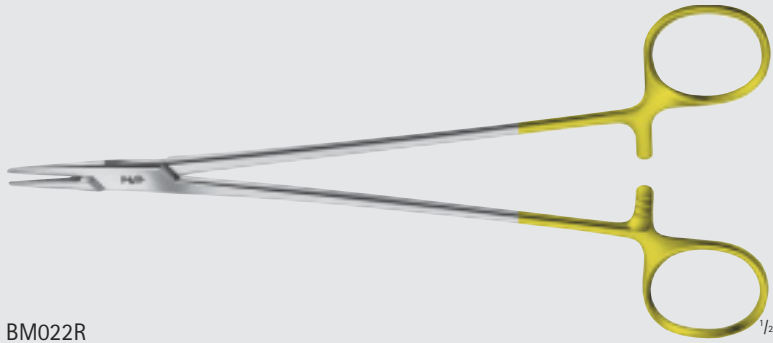

DUROGRIP TC MAYO-HEGAR-SEELEY
Needle Holder

Catalog Number	Jaw	Length (in.)
BM022R	SERR	8

BM022R



BM025R-BM027R



BM025R



BM026R



BM027R

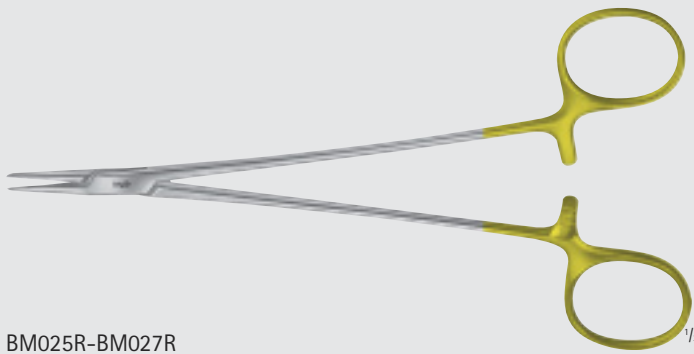

DUROGRIP TC Fine Needle Holder

Catalog Number	Tip	Jaw	Length (in.)
BM025R	X-DEL	SERR	7
BM026R	X-DEL	SERR	8
BM027R	X-DEL	SERR	9



INCHES

General Surgery

DUROGRIP® TC Needle Holders

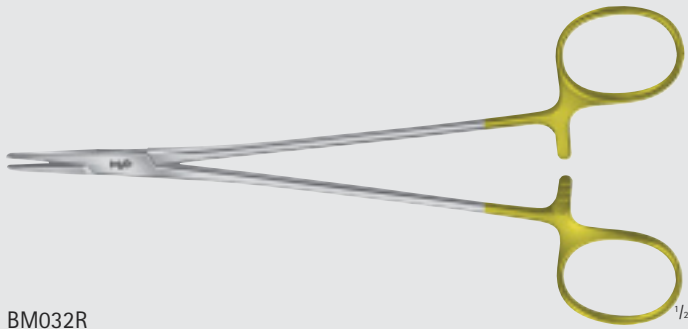

BM032R



DUROGRIP, TC DE BAKEY Needle Holder

Catalog Number	Tip	Jaw	Length (in.)
BM032R	DEL	SERR	6
BM033R	DEL	SERR	6 1/2
BM034R	DEL	SERR	8 1/4
BM063R	X-DEL	SERR	6 1/2
BM064R	X-DEL	SERR	8 1/4
BM035R	DEL	SERR	7
BM036R	DEL	SERR	9
BM037R	DEL	SERR	10
BM038R	DEL	SERR	12

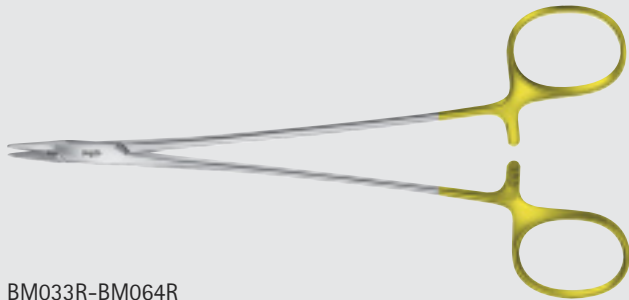

BM033R-BM064R



BM033R



BM034R



BM063R



BM064R

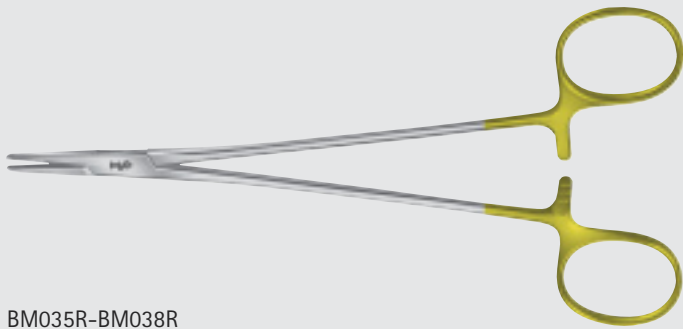

BM035R-BM038R



BM035R



BM036R



BM037R



BM038R

DUROGRIP TC RYDER Needle Holder

Catalog Number	Tip	Jaw	Length (in.)
BM044R		SERR	5 1/4
BM045R		SERR	7
BM046R		SERR	7 3/4
BM047R		SERR	10 1/2
BM054R	DEL	SERR	5 1/4
BM055R	DEL	SERR	6
BM056R	DEL	SERR	7
BM057R	DEL	SERR	8 1/4
BM058R	DEL	SERR	9
BM074R	DEL	SMOOTH	6
BM075R	DEL	SMOOTH	7
BM076R	DEL	SMOOTH	9

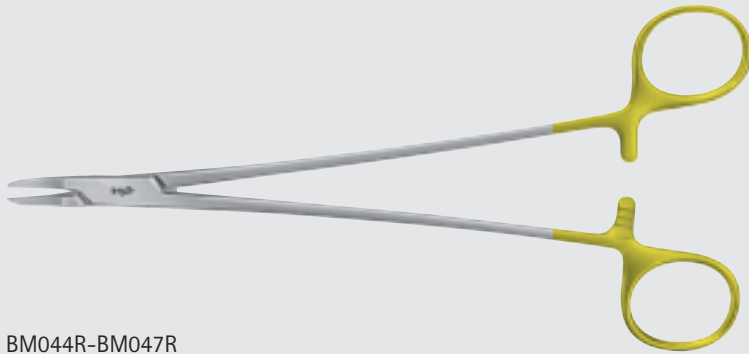

BM044R-BM047R

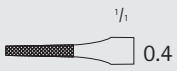

BM044R



BM045R



BM046R



BM047R

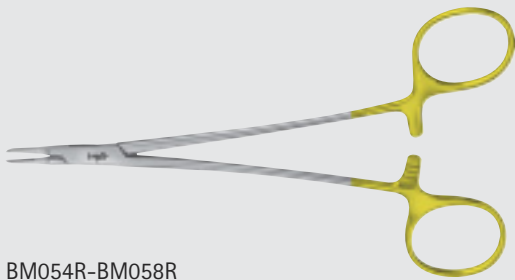

BM054R-BM058R



BM054R



BM055R



BM056R



BM057R



BM058R

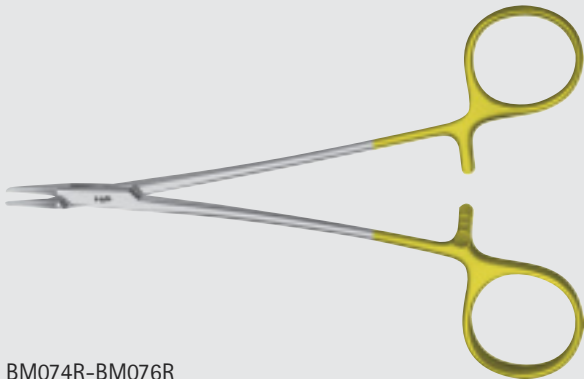

BM074R-BM076R

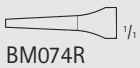

BM074R

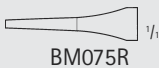

BM075R



BM076R



INCHES

General Surgery

Durogrip® TC Needle Holders

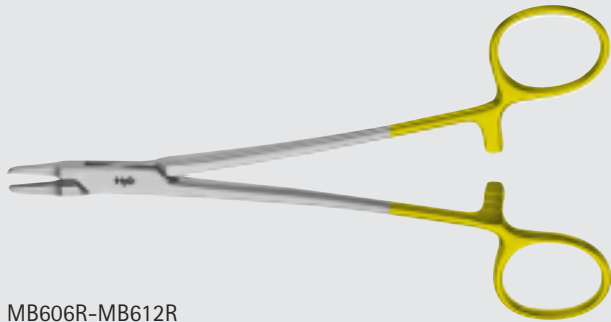

MB606R-MB612R



MB606R



MB607R



MB611R



MB612R

DUROGRIP TC FRENCH Eye Needle Holder

Catalog Number	Jaw	Length (in.)
MB606R	SERR	6 1/4
MB607R	SERR	7 1/4
MB611R	SERR	8
MB612R	SERR	9 1/4



BM184R



DUROGRIP TC Needle Holder

Catalog Number	Tip	Jaw	Length (in.)
BM184R	DEL	SERR	8

General Surgery
DUROGRIP® TC Needle Holders

GENL

DUROGRIP TC MAYO-HEGAR Needle Holder

Catalog Number	Jaw	Length (in.)
BM065R	SERR	6
BM066R	SERR	7 1/4
BM067R	SERR	8
BM068R	SERR	9 1/4
BM070R	SERR	10 1/2
BM069R	SERR	12
MB617R	SERR	14

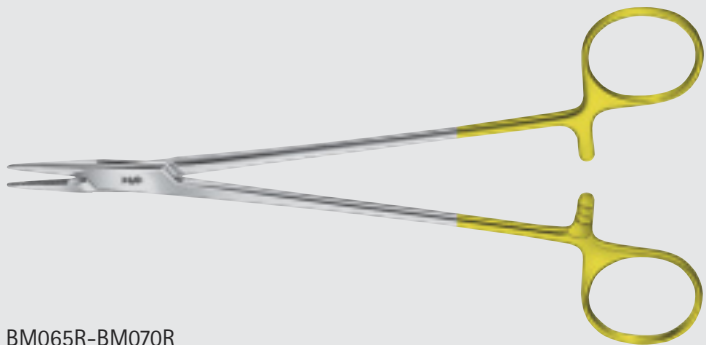

BM065R-BM070R



BM065R



BM066R



BM067R



BM068R



BM070R



BM069R



MB617R



INCHES

General Surgery

DUROGRIP® TC Needle Holder

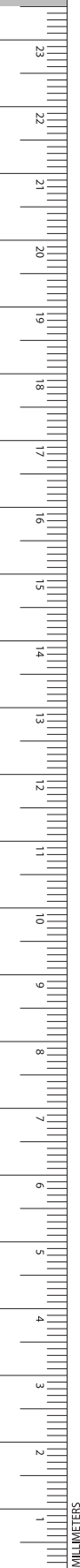
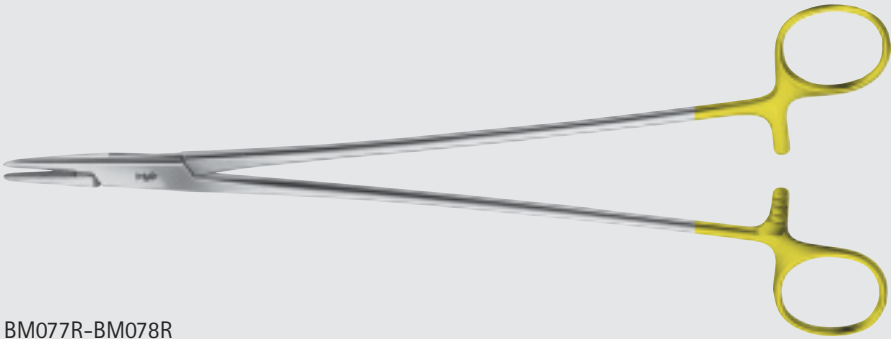
DUROGRIP TC HEGAR Needle Holder

Catalog Number	Tip	Jaw	Length (in.)
BM077R	HVY	SERR	8
BM078R	HVY	SERR	9 3/4

BM077R-BM078R



BM077R



BM078R

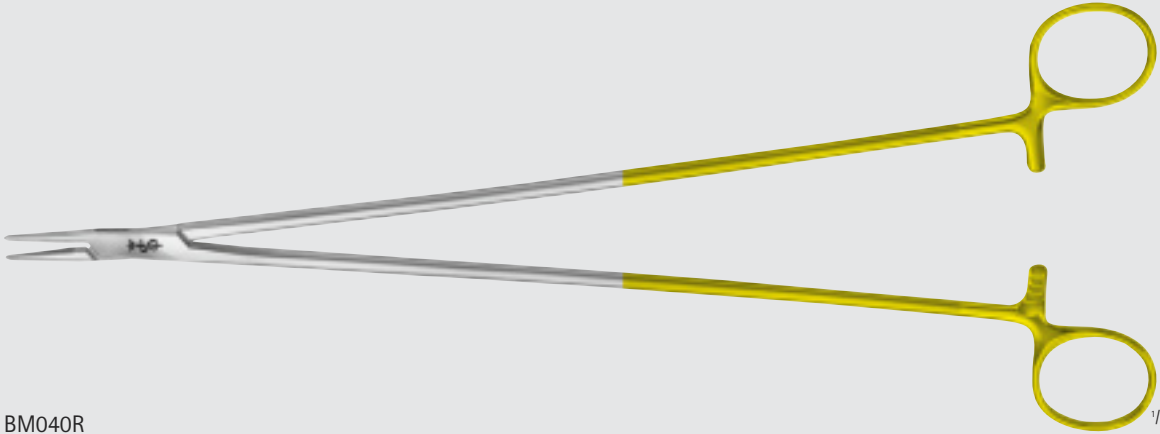

DUROGRIP TC DE BAKEY Needle Holder

Catalog Number	Jaw	Length (in.)
BM040R	SERR	12

BM040R



DUROGRIP TC WANGENSTEEN Needle Holder

Catalog Number	Jaw	Length (in.)
BM042R	SERR	10 3/4

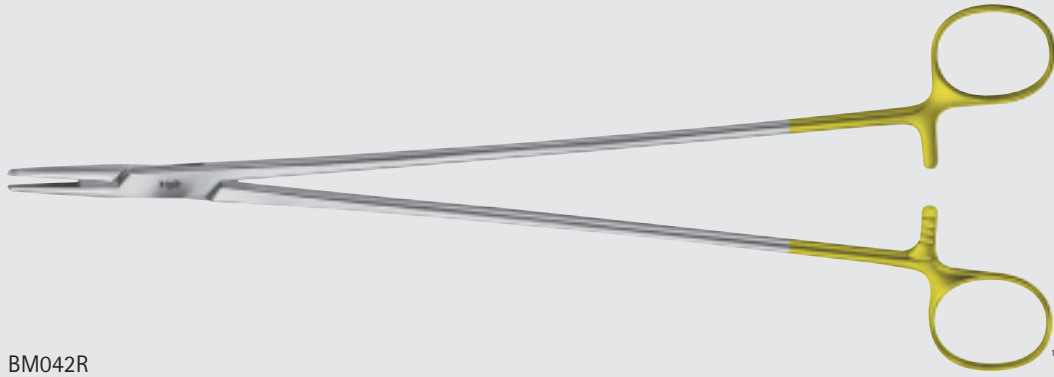

BM042R

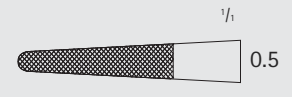

DUROGRIP TC MASSON Needle Holder

Catalog Number	Jaw	Length (in.)
BM090R	SERR	10 1/2

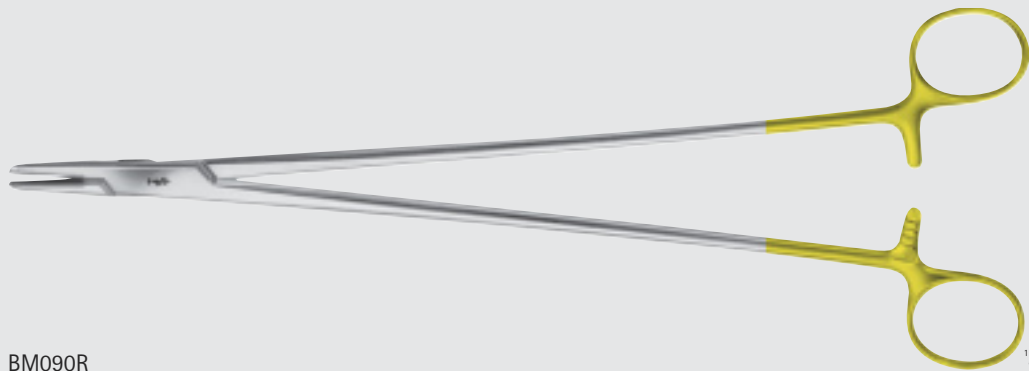

BM090R



DUROGRIP TC HEANEY Needle Holder

Catalog Number	Tip	Jaw	Length (in.)
BM081R	CVD	SERR	8
BM084R	CVD	SERR	10 1/4

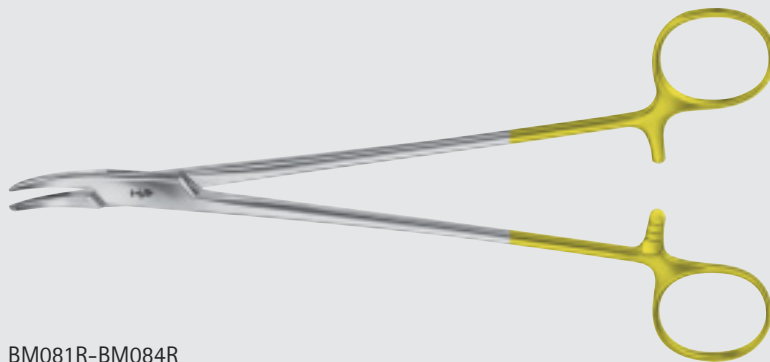

BM081R-BM084R

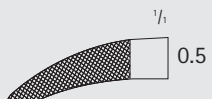

BM081R

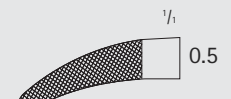

BM084R



INCHES

General Surgery

DUROGRIP® TC Needle Holders

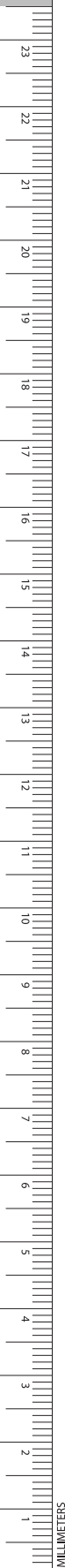

DUROGRIP TC MUELLER Needle Holder

Catalog Number	Tip	Jaw	Length (in.)
BM089R	CVD	SERR	14

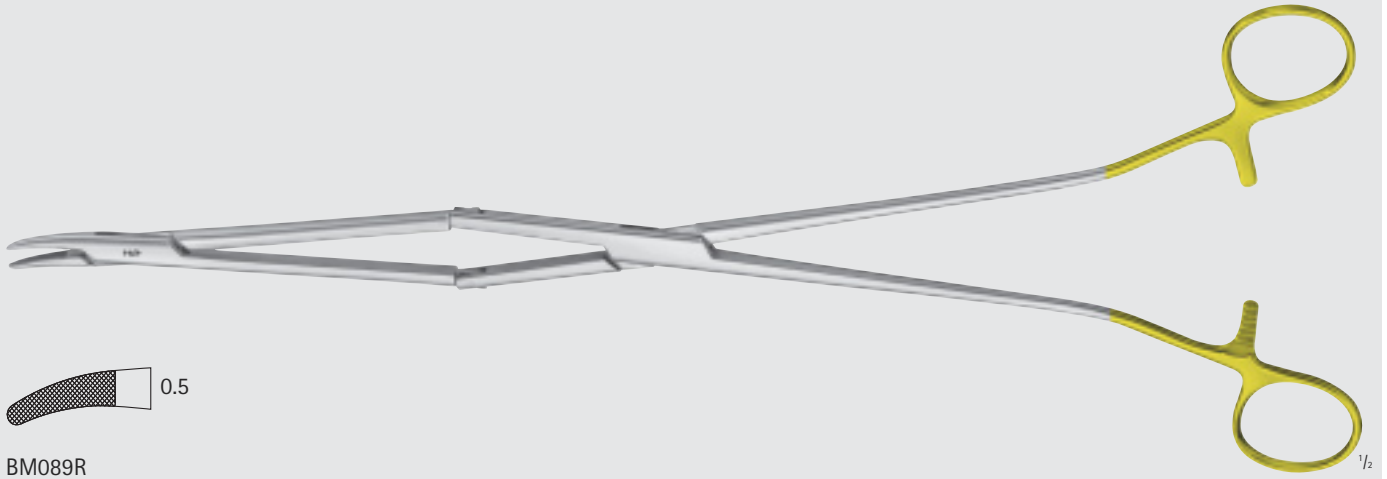

BM089R

DUROGRIP TC FINOCHIETTO Needle Holder

Catalog Number	Tip	Jaw	Length (in.)
BM092R	ANG	SERR	10 1/2

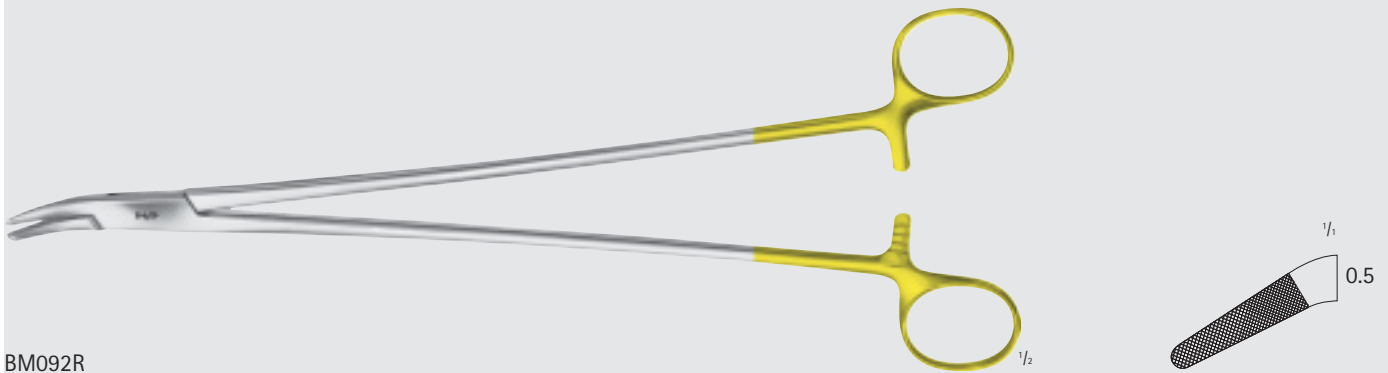

BM092R

DUROGRIP TC STRATTE Needle Holder

Catalog Number	Tip	Jaw	Length (in.)
BM095R	CVD	SERR	8 1/4
BM096R	CVD	SERR	9

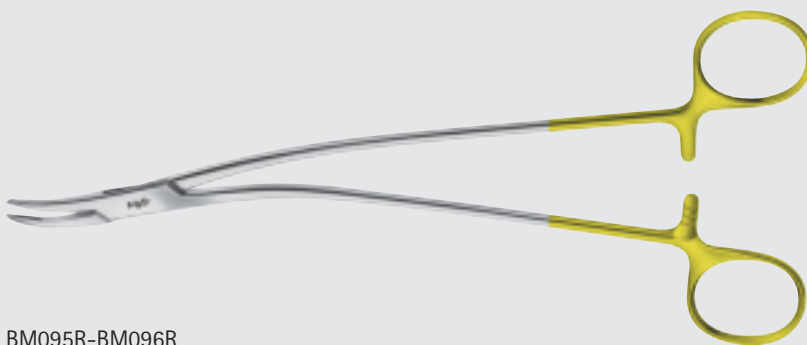

BM095R-BM096R

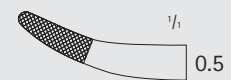

BM095R

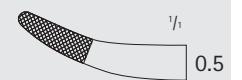

BM096R

DUROGRIP TC Wire Twister

Catalog Number	Tip	Jaw	Length (in.)
BM110R	RND	SERR	6
BM111R	SQ	SERR	6

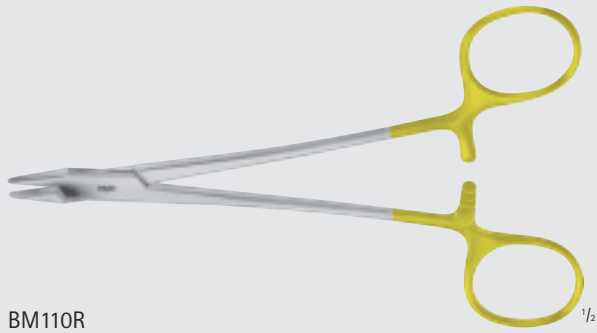

BM110R

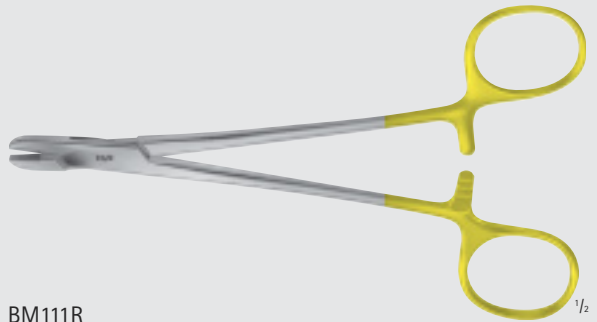
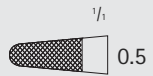

BM111R

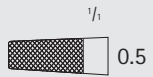

DUROGRIP TC BAUMGARNER Wire Twister

Catalog Number	Tip	Jaw	Length (in.)
BM112R	SQ	SERR	8

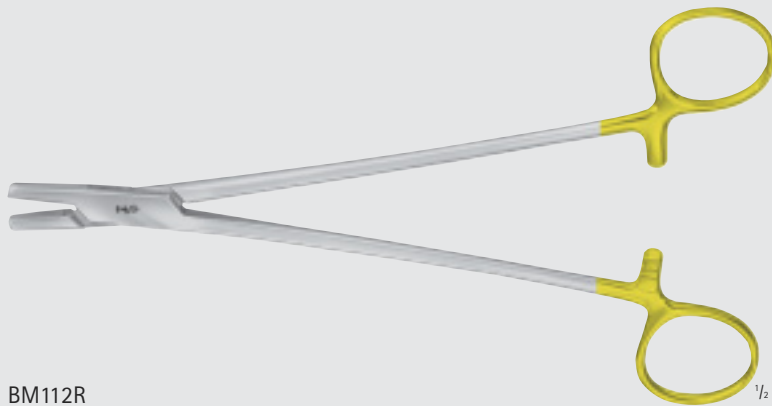

BM112R



INCHES

General Surgery

DUROGRIP® TC Needle Holders

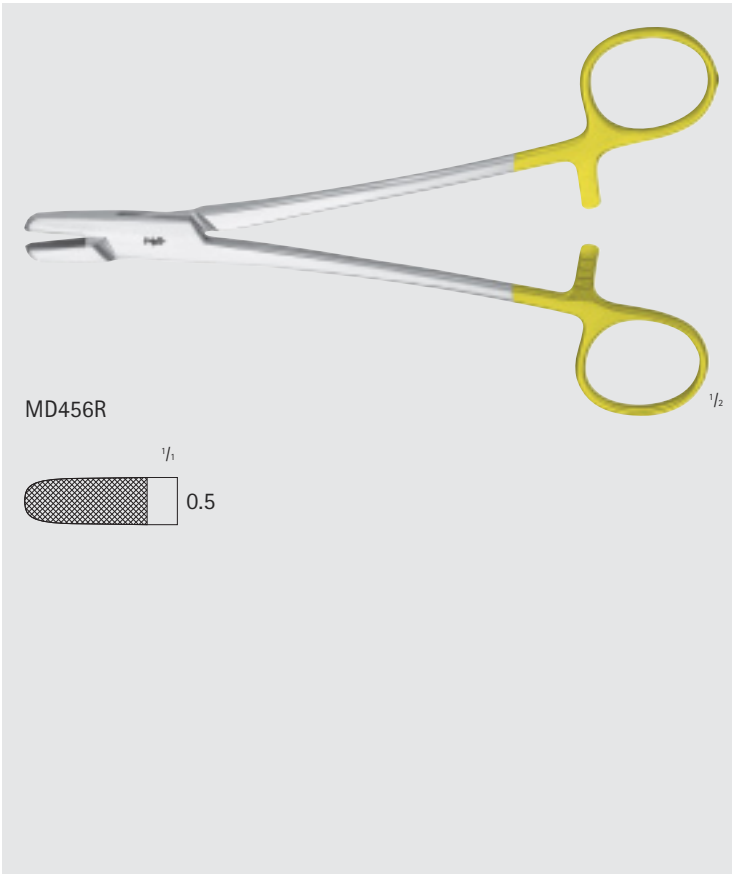

DUROGRIP TC BERRY Wire Twister

Catalog Number	Tip	Jaw	Length (in.)
MD456R	RND	SERR	7 1/4

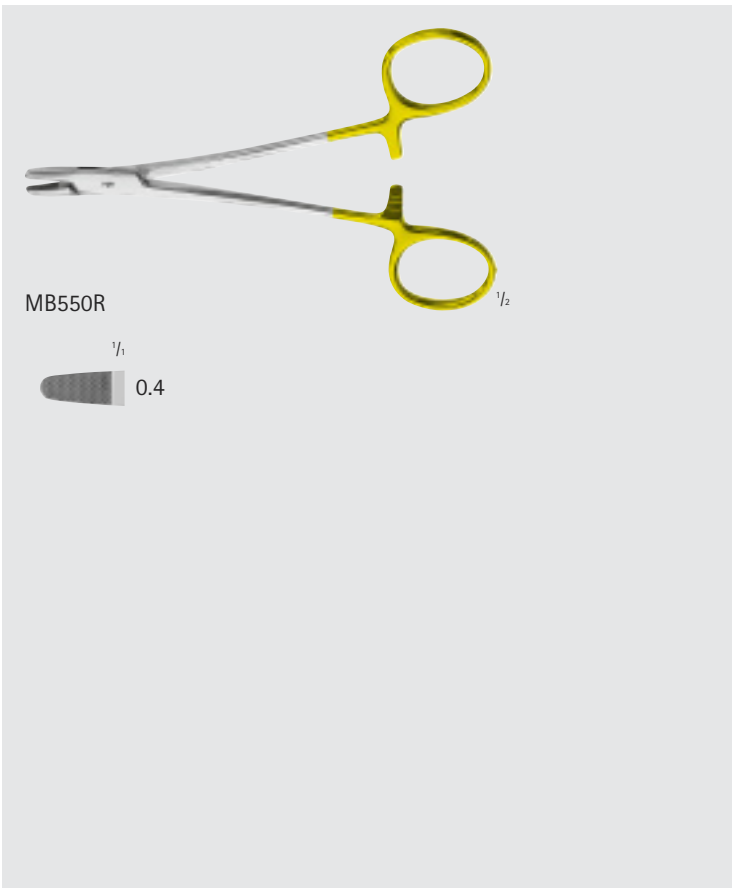

DUROGRIP TC RUBIO Wire Twister

Catalog Number	Tip	Jaw	Length (in.)
MB550R	RND	SERR	5

DUROGRIP TC MATHIEU Needle Holder

Catalog Number	Jaw	Length (in.)
BM149R	SERR	5 1/2
BM151R	SERR	6 3/4
BM154R	SERR	8

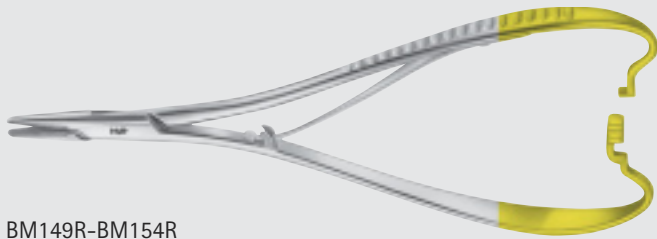

BM149R-BM154R



BM149R

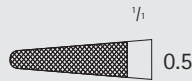

BM151R



BM154R

DUROGRIP TC MATHIEU Needle Holder, Heavy

Catalog Number	Jaw	Length (in.)
BM156R	SERR	8
BM158R	SERR	9 3/4



BM156R-BM158R

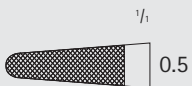

BM156R



BM158R

DUROGRIP TC AESCULAP Needle Holder, Double Action

Catalog Number	Jaw	Length (in.)
BM178R	SERR	8

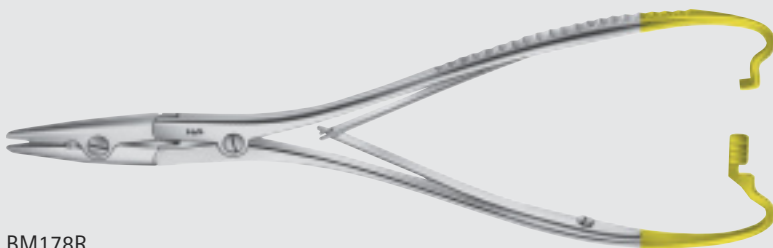

BM178R



General Surgery

Needle Cases



Needle Case

Catalog Number	Dimensions (mm)
BL907R	70x53x9



BL929R-BL930R



BL931R-BL933R

Needle Cases

Catalog Number	Item	Dimensions (mm)
BL929R	EXTERIOR BOX ONLY	65 x 16
BL930R	COMPLETE NEEDLE CASE W/INTERIOR BOX	65 x 16
BL931R	INTERIOR BOX ONLY	62 x 12
BL933R	INTERIOR BOX ONLY	90 x 12



Needle Case, With 7 Sections

Catalog Number	Dimensions (mm)
BL941R	150x90x10

DESCHAMPS Needles, Right

Catalog Number	Hand Orientation	Tip	Length (in.)
BM814R	RIGHT	STEEP, BLUNT, 2.5MM	9
BM822R	RIGHT	BLUNT, 3.5MM	9 1/2
BM824R	RIGHT	BLUNT, 5MM	11



BM814R

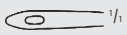

BM822R

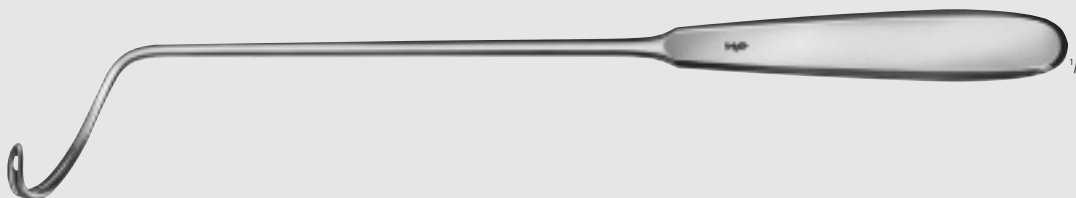
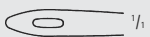

BM824R

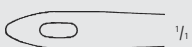

INCHES

General Surgery

Ligature Needles



BM749R

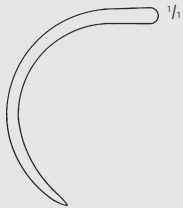
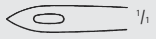

BM781R

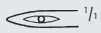

BM807R



DESCHAMPS Needles, Left

Catalog Number	Hand Orientation	Tip	Length (in.)
BM749R	LEFT	SHARP, 3.5MM	8 1/2
BM781R	LEFT	SHARP, 2MM	8 1/4
BM807R	LEFT	BLUNT, 2.5MM	8 1/2

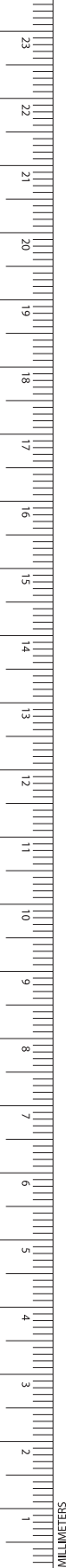

DESCHAMPS Needles, Left
(continued)

Catalog Number	Hand Orientation	Tip	Length (in.)
BM809R	LEFT	BLUNT, 2.5MM	8 1/4
BM811R	LEFT	BLUNT, 3.5MM	8 1/2
BM813R	LEFT	STEEP, BLUNT, 2MM	9



BM809R

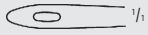

BM811R

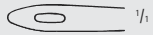

BM813R



INCHES

General Surgery

Ligature Needles

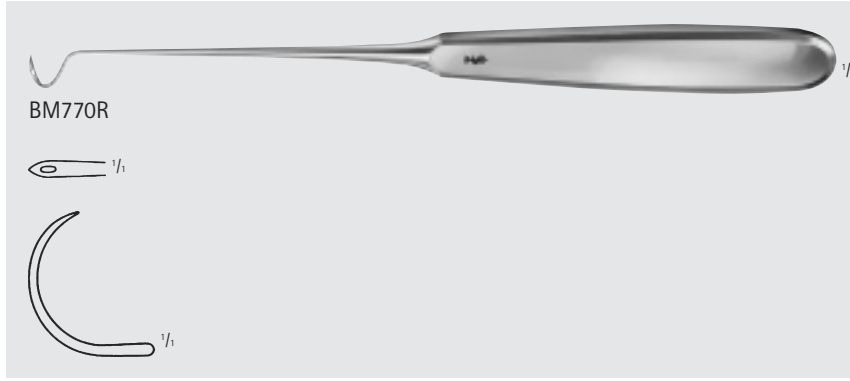

BM770R

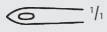

HURD Needle, Right

Catalog Number	Hand Orientation	Tip	Length (in.)
BM770R	RIGHT	SHARP	8 1/4



BM771R

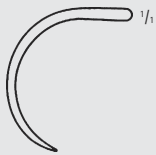

HURD Needle, Left

Catalog Number	Hand Orientation	Tip	Length (in.)
BM771R	LEFT	SHARP	8 1/4

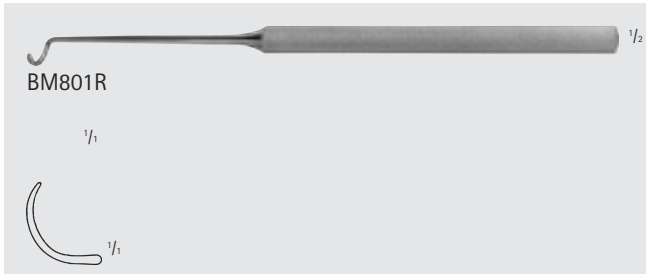

BM801R



KRONECKER Needle, Right

Catalog Number	Hand Orientation	Tip	Length (in.)
BM801R	RIGHT	BLUNT	6



BM802R



KRONECKER Needle, Left

Catalog Number	Hand Orientation	Tip	Length (in.)
BM802R	LEFT	BLUNT	6

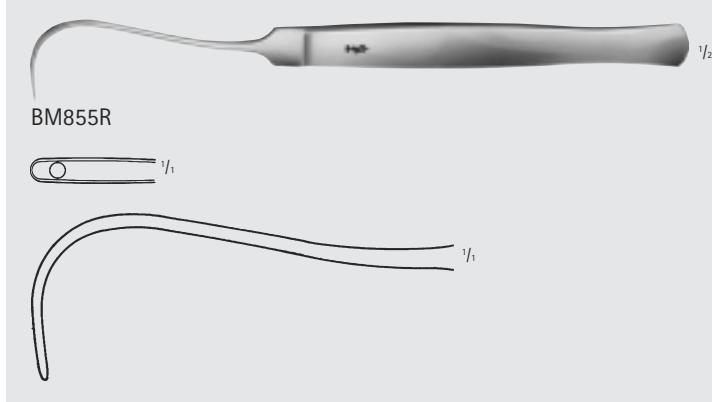

BM855R



SYME Suture Needle

Catalog Number	Tip	Length (in.)
BM855R	BLUNT	6 3/4



BD043R-BD053R



BD043R

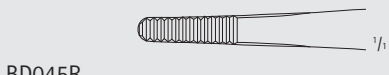

BD045R

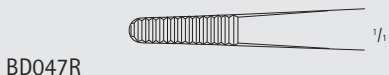

BD047R



BD049R

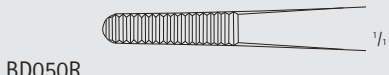

BD050R

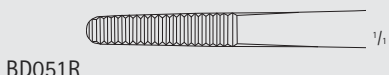

BD051R

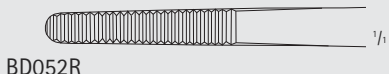

BD052R

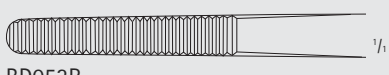

BD053R

Dressing Forceps, Standard Patterns

Catalog Number	Tip	Length (in.)
BD043R	SERR	4 1/2
BD045R	SERR	5 1/8
BD047R	SERR	5 3/4
BD049R	SERR	6 1/4
BD050R	SERR	7
BD051R	SERR	8
BD052R	SERR	10
BD053R	SERR	12



BD077R

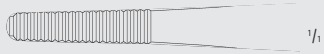

Tissue Forceps, Extra Large

Catalog Number	Tip	Length (in.)
BD077R	SERR	5 3/4

Monopolar Diathermy Forceps, Insulated

Catalog Number	Length (in.)
GK033R	14

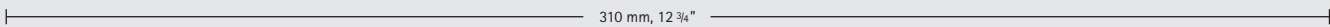

GK033R



General Surgery

Dressing and Tissue Forceps

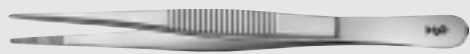

BD023R-BD033R



BD023R

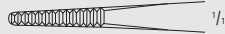

BD025R



BD027R



BD029R

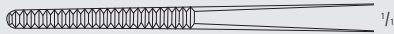

BD033R



BD035R-BD037R

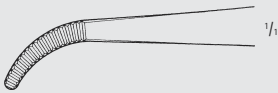

BD035R

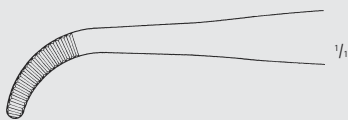

BD037R

Dressing Forceps, Delicate

Catalog Number	Tip	Length (in.)
BD023R	STR, SERR	4 1/2
BD025R	STR, SERR	5 1/8
BD027R	STR, SERR	5 3/4
BD029R	STR, SERR	6 1/4
BD033R	STR, SERR	12
BD035R	CVD, SERR	5 1/8
BD037R	CVD, SERR	5 1/2



BD210R



Dressing Forceps, Extra Delicate

Catalog Number	Tip	Length (in.)
BD210R	STR, SERR	4 1/2

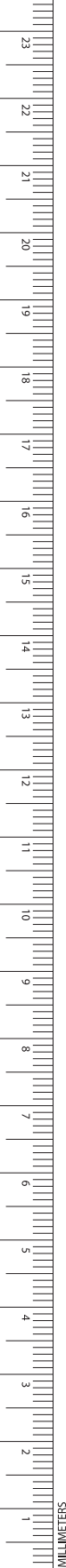

Tissue Forceps

Catalog Number	Tip	Teeth	Length (in.)
BD527R	CVD	1 x 2	5 3/4
BD533R	STR	1 x 2	4 1/2
BD535R	STR	1 x 2	5 1/8
BD537R	STR	1 x 2	5 3/4
BD539R	STR	1 x 2	6 1/4
BD547R	STR	1 x 2	5 3/4
BD549R	STR	1 x 2	6 1/4
BD579R	STR	2 x 3	6 1/4
BD575R	STR	2 x 3	5 1/8
BD577R	STR	2 x 3	5 3/4
BD580R	STR	2 x 3	7
BD581R	STR	2 x 3	8
BD587R	STR	3 x 4	5 3/4
BD589R	STR	3 x 4	6 1/4
BD591R	STR	3 x 4	8

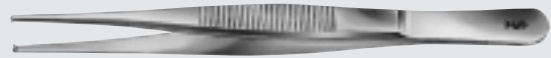

BD527R-BD533R

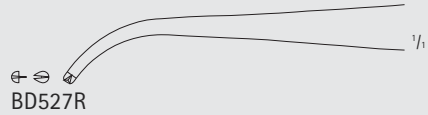

BD527R

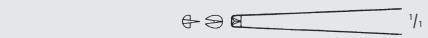

BD533R



BD535R-BD539R



BD535R

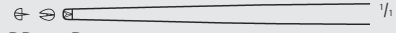

BD537R

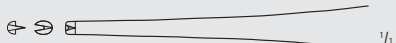

BD539R



BD547R-BD579R

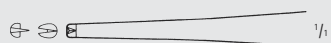

BD547R

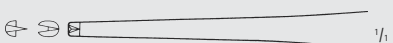

BD549R



BD579R



BD575R-BD581R

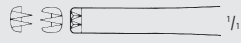

BD575R

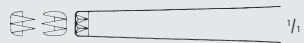

BD577R

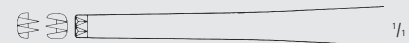

BD580R

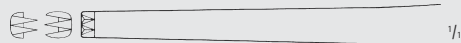

BD581R



BD587R-BD591R

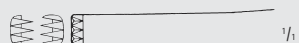

BD587R

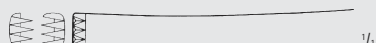

BD589R

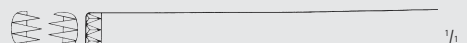

BD591R



INCHES

General Surgery

Dressing and Tissue Forceps



MB803R

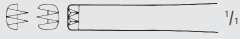

Tissue Forceps (continued)

Catalog Number	Teeth	Length (in.)
MB803R	2 x 3	4 1/2



BD553R-BD563R

BD553R

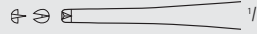

BD555R

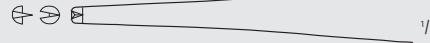

BD557R

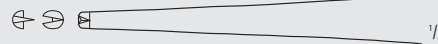

BD559R

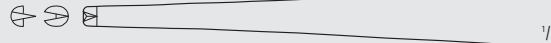

BD560R

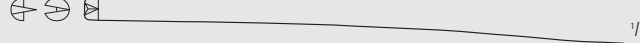

BD561R



BD562R

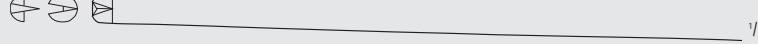

BD563R



Tissue Forceps, Standard Patterns

Catalog Number	Teeth	Length (in.)
BD553R	1 x 2	4 1/2
BD555R	1 x 2	5 1/8
BD557R	1 x 2	5 3/4
BD559R	1 x 2	6 1/4
BD560R	1 x 2	7
BD561R	1 x 2	8
BD562R	1 x 2	10
BD563R	1 x 2	12

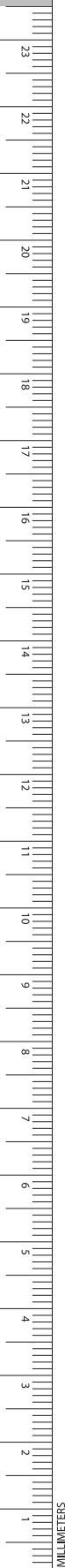



BD690R-BD692R

STRASSBURGER Tissue Forceps

Catalog Number	Tip	Teeth	Length (in.)
BD690R	SERR	1 x 2	6
BD692R	SERR	1 x 2	8

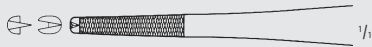

BD690R

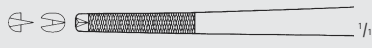

BD692R



BD693R

BONNEY Tissue Forceps

Catalog Number	Tip	Teeth	Length (in.)
BD693R	SERR	1 x 2	7

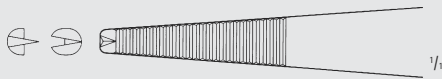

BD733R

MARTIN Tissue Forceps

Catalog Number	Teeth	Length (in.)
BD733R	7 x 8	6



MB224

HEANEY Tissue Forceps

Catalog Number	Teeth	Length (in.)
MB224	2 x 3	5 1/2



General Surgery

Dressing and Tissue Forceps



BD725R-BD727R

STILLÉ-BARRAYA CV Forceps

Catalog Number	Tip	Teeth	Length (in.)
BD725R	SERR	3 x 4	7
BD726R	SERR	3 x 4	8
BD727R	SERR	3 x 4	10

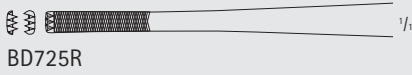

BD725R

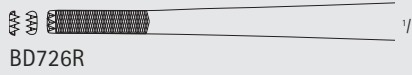

BD726R

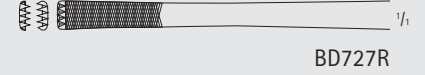

BD727R



BD755R

RUSSIAN Tissue Forceps

Catalog Number	Length (in.)
BD755R	6
BD760R	8
BD761R	10 1/4
XG006R	10

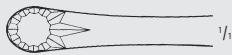

BD760R-XG006R

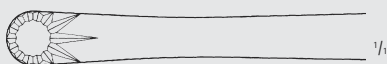

BD760R



BD761R

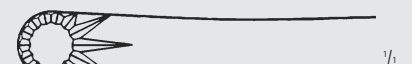

XG006R



MB795R

SELMAN Tissue Forceps

Catalog Number	Length (in.)
MB795R	8



MB208R

C.W. MAYO Tissue Forceps

Catalog Number	Tip	Length (in.)
MB208R	FENESTRATED	9

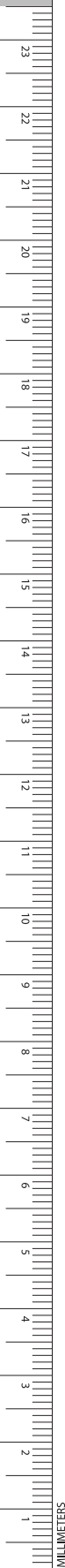



BD878R

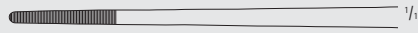

BD879R



LUCAE Bayonet Forceps

Catalog Number	Tip	Teeth	Length (in.)
BD878R	SERR		5 1/2
BD879R		1 x 2	5 1/2



BD883R

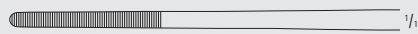

GRUENWALD Bayonet Forceps

Catalog Number	Tip	Length (in.)
BD883R	SERR	8



MB231



CUSHING Bayonet Forceps

Catalog Number	Teeth	Length (in.)
MB231	1 x 2	7 1/4



MB227



BROWN-CUSHING Bayonet Forceps

Catalog Number	Teeth	Length (in.)
MB227	7 x 7	7 1/4



BD876R-MB804R

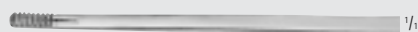

BROWN-BAHNSON Bayonet Forceps

Catalog Number	Tip	Length (in.)
BD876R	SERR	6
MB804R	SERR	8

General Surgery

Dressing and Tissue Forceps



MB236

JANSEN Bayonet Forceps

Catalog Number	Tip	Length (in.)
MB236	SERR	6 1/2

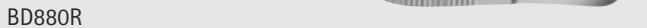

BD880R

JANSEN Bayonet Forceps

Catalog Number	Tip	Length (in.)
BD880R	SERR	6 1/4



BD885R

Bayonet Forceps

Catalog Number	Tip	Teeth	Length (in.)
BD885R	SMOOTH		7 1/4
BD886R		1 x 2	8

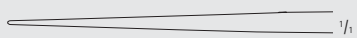

BD886R

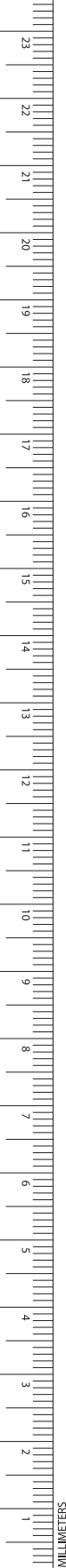
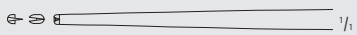



Bayonet Forceps

Catalog Number	Tip	Length (in.)
BD887R	SMOOTH	6 1/4
FD110R	FINE	7 1/4
FD111R	BROAD	7 1/4

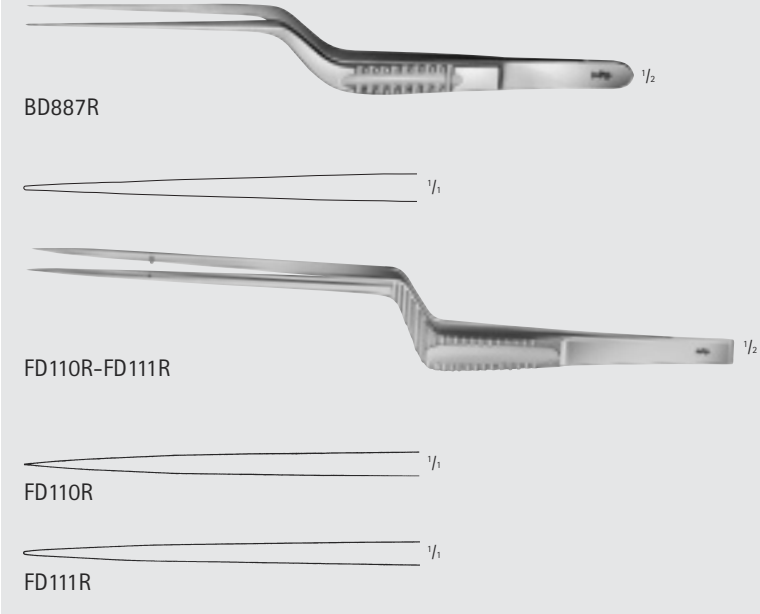

TROELTSCH Bayonet Forceps

Catalog Number	Tip	Length (in.)
BD900R	ANG/SERR	4

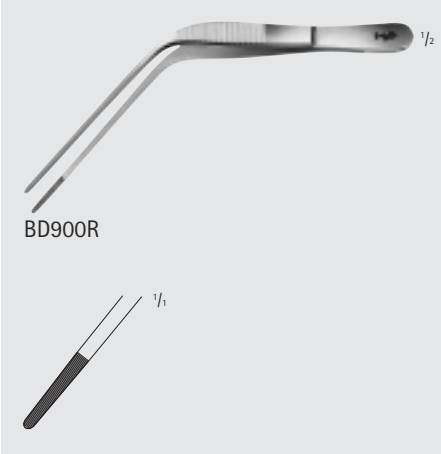

WILDE Bayonet Forceps

Catalog Number	Tip	Length (in.)
BD904R	ANG/SERR	4 1/2

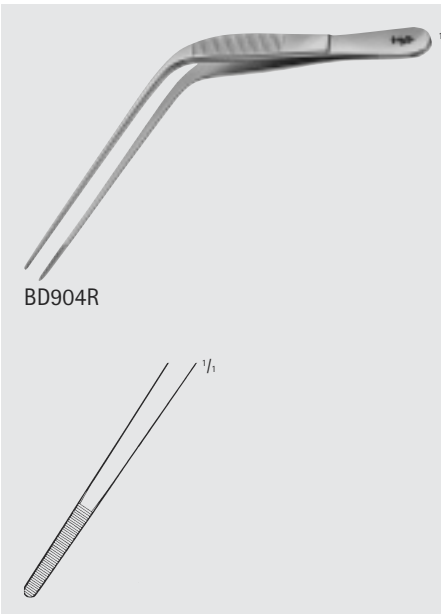

General Surgery

Dressing and Tissue Forceps



BD225R-MB291R



BD225R



MB291R

HUDSON Dressing Forceps

Catalog Number	Tip	Teeth	Length (in.)
BD225R	SERR		5
MB291R		1 x 2	4 7/8



BD610R-BD611R



BD610R



BD611R

FERRIS-SMITH Tissue Forceps

Catalog Number	Tip	Teeth	Length (in.)
BD610R	SERR	1 x 2	7
BD611R	SERR	2 x 3	7



BD215R-BD216R



BD215R



BD216R

SEMKEN Dressing Forceps, Delicate

Catalog Number	Tip	Length (in.)
BD215R	STR, SERR	5
BD216R	STR, SERR	6



BD665R-BD667R

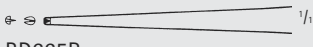

BD665R



BD666R

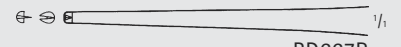

BD667R

SEMKEN Tissue Forceps, Delicate

Catalog Number	Teeth	Length (in.)
BD665R	1 x 2	5
BD666R	2 x 3	5
BD667R	1 x 2	6

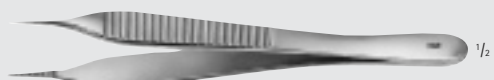

BD220R

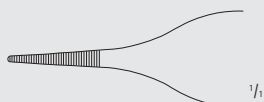

BD223R

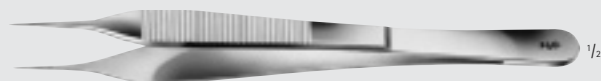

MICRO-ADSON Forceps, Delicate

Catalog Number	Tip	Length (in.)
BD220R	SERR	4 3/4
BD223R	SERR	6

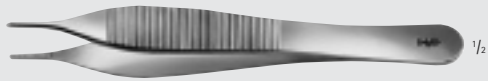

BD222R

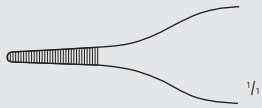

ADSON Forceps, Delicate

Catalog Number	Tip	Length (in.)
BD222R	SERR	4 3/4

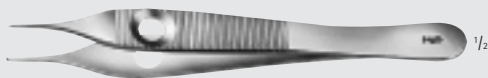

BD506R

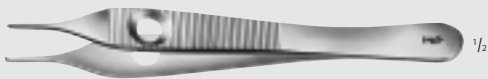

BD507R

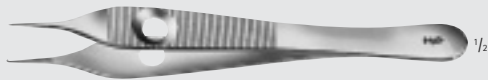

BD508R

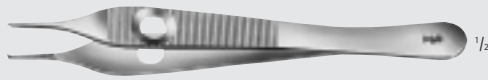

BD513R

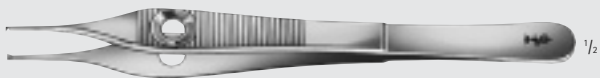

BD521R

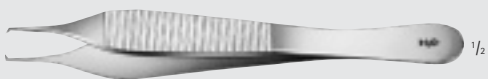

BD511R



BD512R

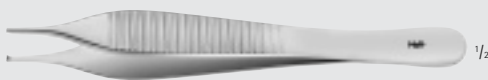

MB454R

ADSON Tissue Forceps, Delicate

Catalog Number	Tip	Teeth	Length (in.)
BD506R		1 x 2	4 3/4
BD507R		1 x 2	4 3/4
BD508R	SERR	1 x 2	4 3/4
BD513R	SERR	1 x 2	4 3/4
BD521R		1 x 2	6
BD511R		1 x 2	4 3/4
BD512R	SERR	1 x 2	4 3/4
MB454R		2 x 3	4 3/4

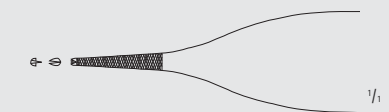
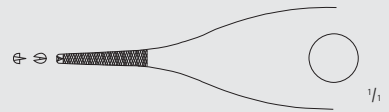
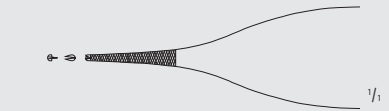

General Surgery

Dressing and Tissue Forceps

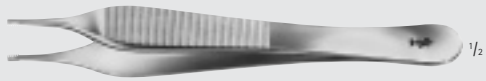

BD700R

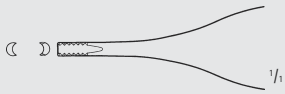

ADSON-BROWN Tissue Forceps

Catalog Number	Teeth	Length (in.)
BD700R	7 x 8	4 3/4



BD701R

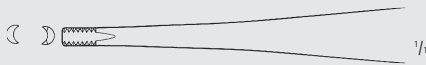

BROWN Tissue Forceps

Catalog Number	Teeth	Length (in.)
BD701R	7 x 8	6

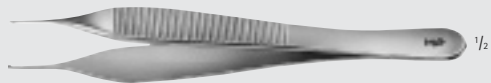

BD510R

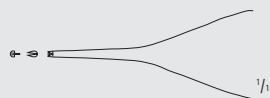

MICRO-ADSON Tissue Forceps, Delicate

Catalog number	Teeth	Length (in.)
BD510R	1 x 2	4 3/4
BD520R	1 x 2	6



BD662R-BD664R

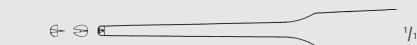

BD662R



BD663R

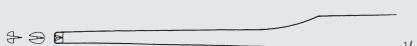

BD664R

GERALD Tissue Forceps, Delicate

Catalog Number	Tip	Teeth	Length (in.)
BD662R	STR	1 x 2	7
BD663R	CVD	1 x 2	7
BD664R	STR	1 x 2	9



BD522R

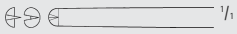

ADSON Tissue Forceps, Delicate

Catalog Number	Teeth	Length (in.)
BD522R	1 x 2	7



BD523R

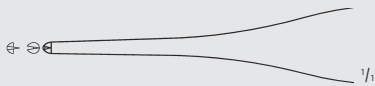

JEFFERSON Tissue Forceps, Delicate

Catalog Number	Teeth	Length (in.)
BD523R	1 x 2	7



BD228R-BD230R



BD228R

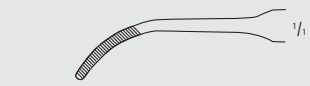

BD229R

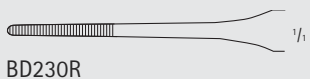

BD230R

GERALD Dressing Forceps, Delicate

Catalog Number	Tip	Length (in.)
BD228R	STR, SERR	7
BD229R	CVD, SERR	7
BD230R	STR, SERR	9



INCHES

General Surgery

Dressing and Tissue Forceps



BD702R

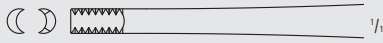

BROWN Side-Grasping Tissue Forceps

Catalog Number	Teeth	Length (in.)
BD702R	7 x 8	8



BD236R

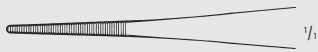

MC INDOE Delicate Thumb Forceps

Catalog Number	Tip	Length (in.)
BD236R	SERR	6



BD661R



MC INDOE Tissue Forceps, Delicate

Catalog Number	Teeth	Length (in.)
BD661R	1 x 2	6



BD257R

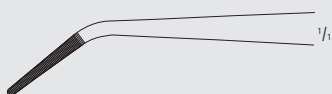

Delicate Angled Forceps

Catalog Number	Tip	Length (in.)
BD257R	SERR	8



BD238R-BD243R



BD238R



BD239R

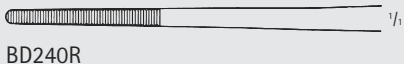

BD240R

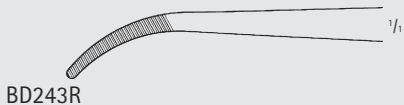

BD243R

CUSHING Forceps, Delicate

Catalog Number	Tip	Length (in.)
BD238R	STR, SERR	7
BD239R	STR, SERR	8
BD240R	STR, SERR	10
BD243R	CVD, SERR	8



MD463

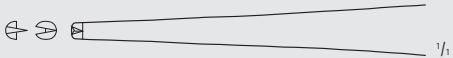

CUSHING Tissue Forceps

Catalog Number	Teeth	Length (in.)
MD463	1 x 2	7



BD246R-BD247R

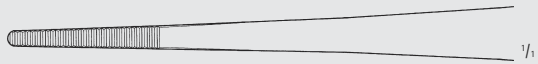

BD246R

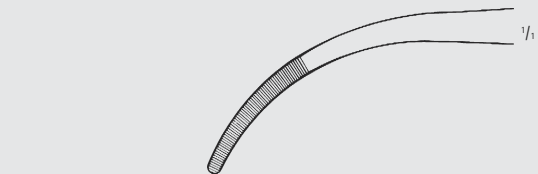

BD247R

BROPHY Forceps, Delicate

Catalog Number	Tip	Length (in.)
BD246R	STR, SERR	8
BD247R	CVD, SERR	8



BD678R



BROPHY Tissue Forceps, Delicate

Catalog Number	Tip	Teeth	Length (in.)
BD678R	CVD	1 x 2	8

General Surgery

Dressing and Tissue Forceps



BD231R-BD232R

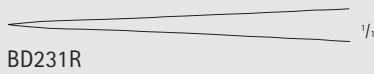

BD231R

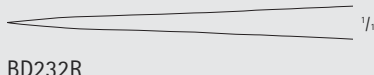

BD232R

Delicate Forceps

Catalog Number	Tip	Length (in.)
BD231R	STR	7
BD232R	STR	8



BD301R-BD305R



BD301R



BD302R



BD303R



BD304R



BD305R



BD311R-BD315R



BD311R



BD312R



BD313R



BD314R

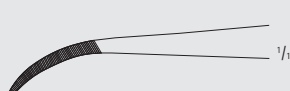

BD315R

Micro Dressing Forceps

Catalog Number	Tip	Length (in.)
BD301R	STR, SERR	3 1/2
BD302R	STR, SERR	4 1/8
BD303R	STR, SERR	4 1/2
BD304R	STR, SERR	5 1/8
BD305R	STR, SERR	5 3/4
BD311R	CVD, SERR	3 1/2
BD312R	CVD, SERR	4 1/8
BD313R	CVD, SERR	4 1/2
BD314R	CVD, SERR	5 1/8
BD315R	CVD, SERR	5 3/4

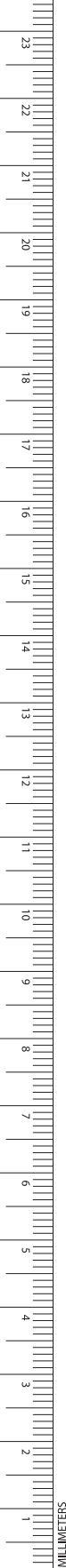



BD500R



BD501R



BD502R

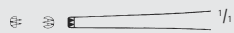

Micro Tissue Forceps

Catalog Number	Teeth	Length (in.)
BD500R	1 x 2	4
BD501R	1 x 2	4 3/8
BD502R	2 x 3	4 3/8



BD330R

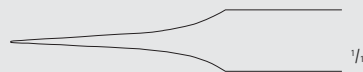

Micro Forceps #4 Jewelers

Catalog Number	Tip Size (mm)	Length (in.)
BD330R	0.2	4 3/8



BD331R

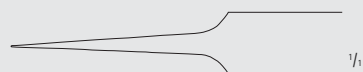

Micro Forceps #5 Jewelers

Catalog Number	Tip Size (mm)	Length (in.)
BD331R	0.15	4 3/8



BD333R

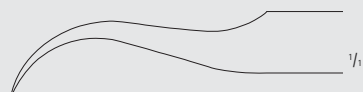

Micro Forceps #7 Jewelers

Catalog Number	Tip Size (mm)	Length (in.)
BD333R	0.2	4 1/2



BD335R



Micro Forceps #3 Jewelers

Catalog Number	Tip Size (mm)	Length (in.)
BD335R	0.3	5 1/4

General Surgery

Dressing and Tissue Forceps

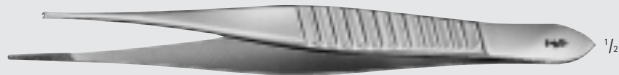

BD660R



GILLIES Tissue Forceps, Delicate

Catalog Number	Tip	Teeth	Length (in.)
BD660R	SERR	1 x 2	6



BD669R-BD679R

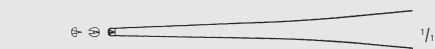

BD669R

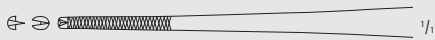

BD670R

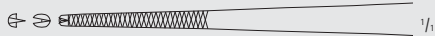

BD671R

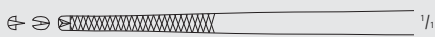

BD672R



BD679R

WAUGH Tissue Forceps, Delicate

Catalog Number	Teeth	Length (in.)
BD669R	1 x 2	5 3/4
BD670R	1 x 2	7
BD671R	1 x 2	8
BD672R	1 x 2	10
BD679R	1 x 2	12



MB211R

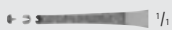

DOCKTOR Forceps

Catalog Number	Teeth	Length (in.)
MB211R	1 x 2	4 3/4

DE BAKEY Atraumatic Ultra Light Forceps

Catalog Number	Tip Size (mm)	Length (in.)
FC411R	1.2	6
FC412R	1.5	8
FC413R	1.5	9 1/2
FC418R	1.5	12

DE BAKEY Atraumatic Vascular Tissue Forceps

Catalog Number	Tip Size (mm)	Length (in.)
FB394R	1	6
FB395R	1	7 3/4
FB396R	1	9 1/2

DE BAKEY Atraumatic Forceps

Catalog Number	Tip Size (mm)	Length (in.)
FB411R	1.5	6
FB412R	1.5	8
FB418R	1.5	9 1/2
FB419R	1.5	12



General Surgery

Dressing and Tissue Forceps



COOLEY Atraumatic Vascular Tissue Forceps

Catalog Number	Tip Size (mm)	Length (in.)
FB784R	1.5	6
FB785R	2.0	7 3/4
FB786R	2.3	9 1/2



COOLEY Vascular Tissue Forceps

Catalog Number	Length (in.)
BD250R	8

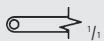

MILLS Mammary/Coronary Tissue Forceps

Catalog Number	Length (in.)
BD770R	7

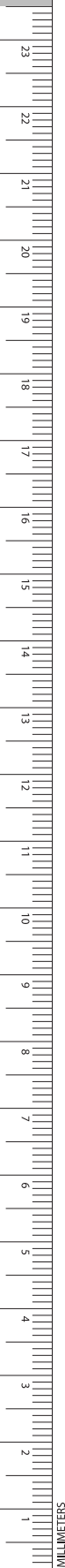

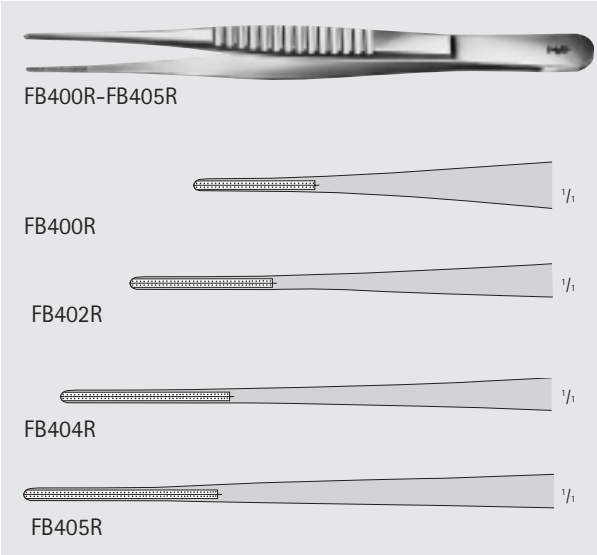

DE BAKEY Atraumatic Forceps

Catalog Number	Tip Size (mm)	Length (in.)
FB400R	2	6
FB402R	2	8
FB404R	2	9 1/2
FB405R	2	12

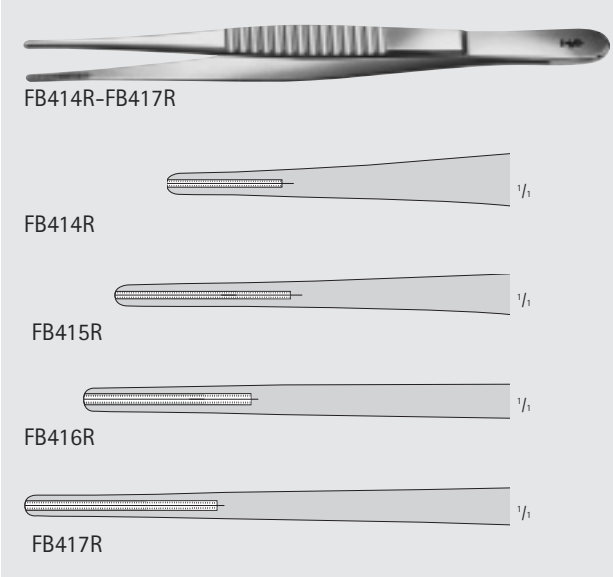

DE BAKEY Atraumatic Forceps
(continued)

Catalog Number	Tip Size (mm)	Length (in.)
FB414R	2.8	6
FB415R	2.8	8
FB416R	2.8	9 1/2
FB417R	2.8	12

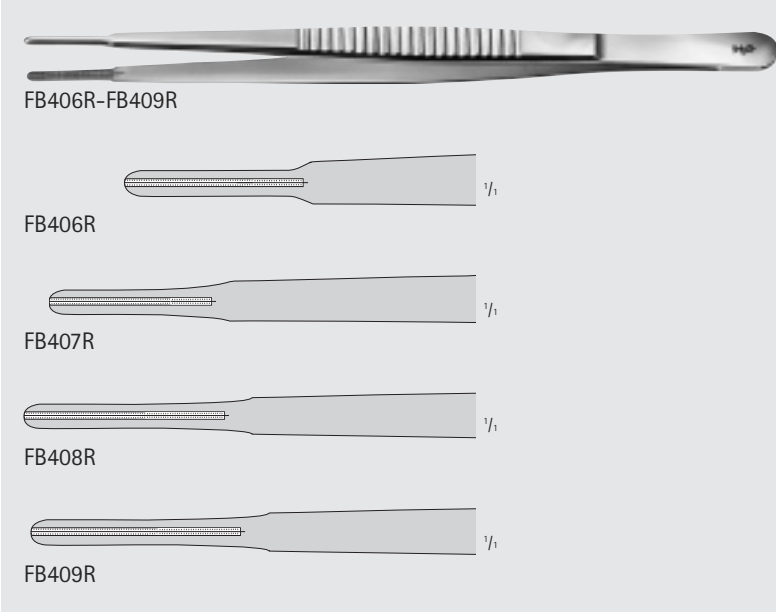

DE BAKEY Atraumatic Forceps
(continued)

Catalog Number	Tip Size (mm)	Length (in.)
FB406R	3.5	8
FB407R	3.5	9 1/2
FB408R	3.5	12
FB409R	3.5	14

General Surgery

Dressing and Tissue Forceps

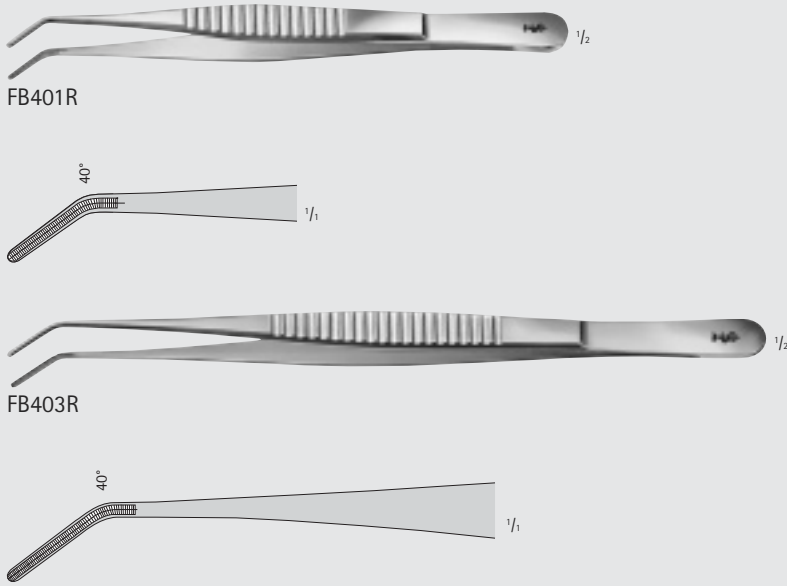

DE BAKEY Atraumatic Forceps, Angled

Catalog Number	Tip Size (mm)	Length (in.)
FB401R	2	6
FB403R	2	8



DE BAKEY Atraumatic Forceps, Angled

Catalog Number	Tip Size (mm)	Length (in.)
FB410R	2	9 1/2

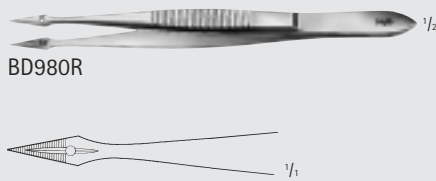

HUNTER Splinter Forceps

Catalog Number	Length (in.)
BD980R	4 1/8

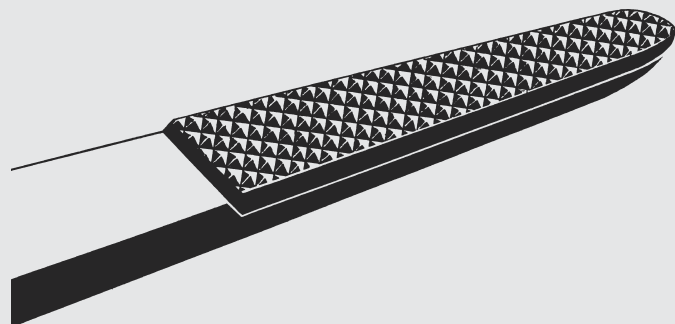

DUROGRIP Tungsten Carbide Tissue Forceps

- Firm and non-traumatic gripping of tissue
- Long working life
- Gold-plated end

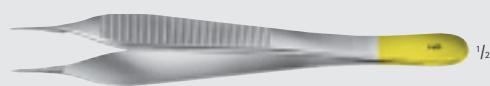

BD151R

DUROGRIP TC ADSON Forceps

Catalog Number	Tip	Length (in.)
BD151R	SERR	4 3/4

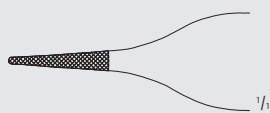

BD154R-BD156R

DUROGRIP TC Thumb Forceps

Catalog Number	Tip	Length (in.)
BD154R	SERR	5 3/4
BD156R	SERR	7
BD158R	SERR	9
BD157R	SERR	8
BD159R	SERR	10



BD154R



BD156R



BD158R

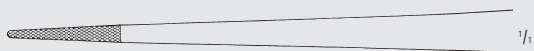

BD157R-BD159R

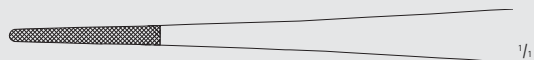

BD157R



BD159R

General Surgery

DUROGRIP® TC Tissue Forceps

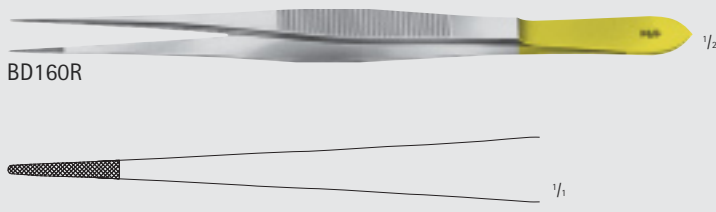

DUROGRIP TC CUSHING Forceps, W/Scraper End

Catalog Number	Tip	Length (in.)
BD160R	SERR	7

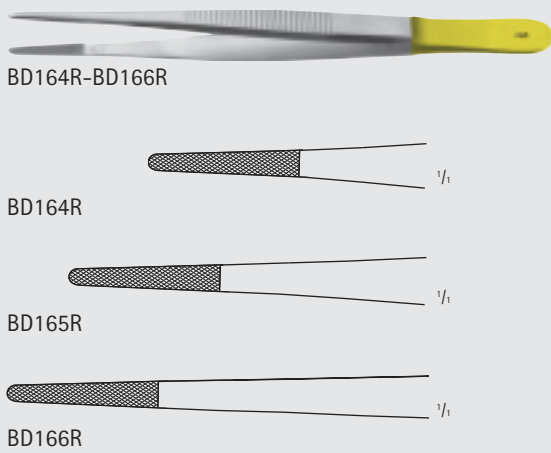

DUROGRIP TC STANDARD Forceps

Catalog Number	Tip	Length (in.)
BD164R	SERR	5 $\frac{3}{4}$
BD165R	SERR	8
BD166R	SERR	10

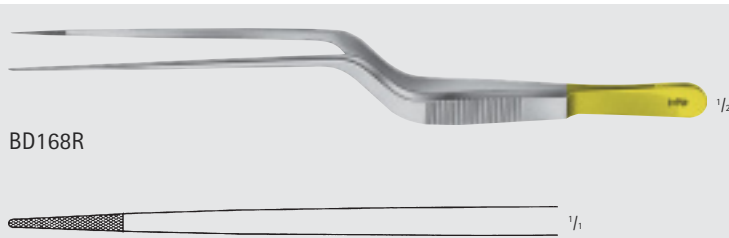

DUROGRIP TC GRUENWALD Forceps

Catalog Number	Tip	Length (in.)
BD168R	SERR	7 $\frac{1}{4}$

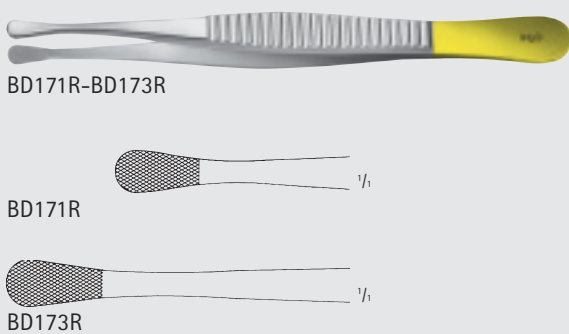

DUROGRIP TC WANGENSTEEN Forceps

Catalog Number	Tip	Length (in.)
BD171R	SERR	6
BD173R	SERR	9

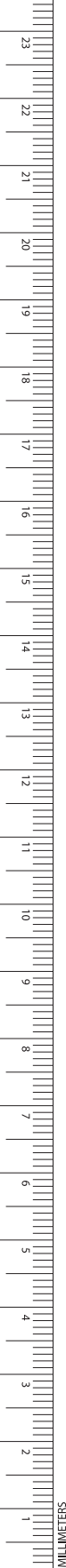



MB308R



CUSHING DUROGRIP TC CUSHING Forceps

Catalog Number	Tip	Length (in.)
MB308R	ANG, SERR	6 1/4

DUROGRIP TC MUELLER Forceps

Catalog Number	Tip	Teeth	Length (in.)
BD185R	SERR	1 x 2	12



BD185R

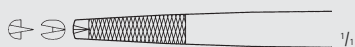

General Surgery

Abdominal & Intestinal Grasping Forceps

GENL

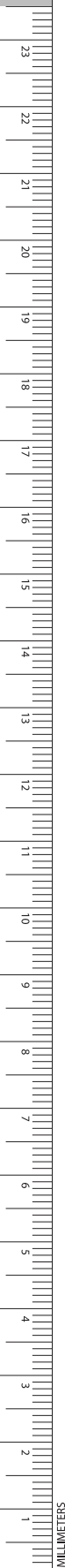

BF309R

1/2

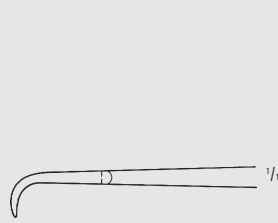

9 mm



LAHEY Forceps

Catalog Number	Teeth	Length (in.)
BF309R	2 x 2	6
BF310R	3 x 3	6
BF311R	4 x 4	6

BF309R

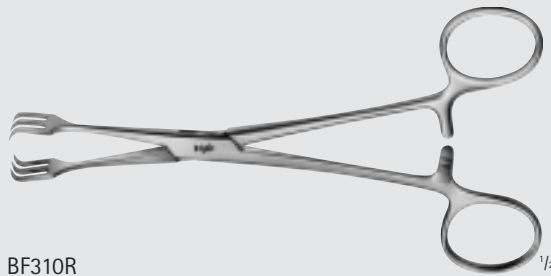

BF310R

1/2

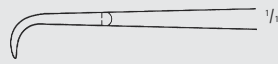

9 mm



BF310R

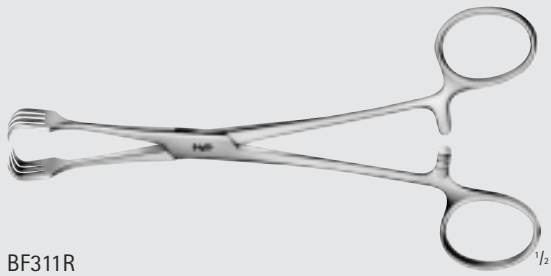

BF311R

1/2

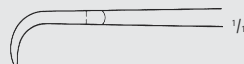

10 mm



BF311R

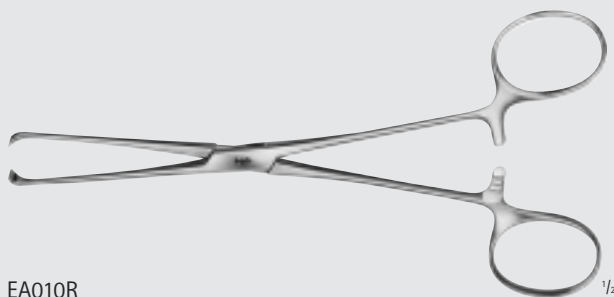

EA010R

1/2

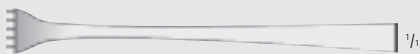

BOYS-ALLIS Forceps

Catalog Number	Teeth	Length (in.)
EA010R	5 x 6	6

General Surgery

Abdominal & Intestinal Grasping Forceps

GENL

BABY-ALLIS Forceps

Catalog Number	Teeth	Length (in.)
EA012R	4 x 5	5 1/8

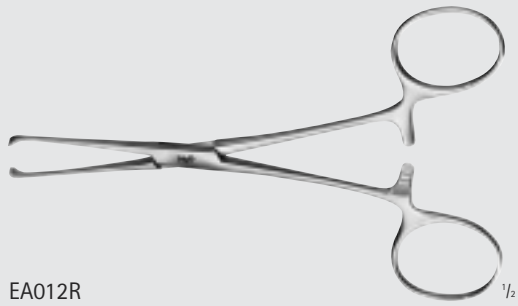

EA012R

1/2



1/4

ALLIS Forceps

Catalog Number	Teeth	Length (in.)
EA015R	4 x 5	6
EA016R	5 x 6	6
EA017R	5 x 6	7 1/2
EA018R	5 x 6	10
FB938R	5 x 6	8 3/4

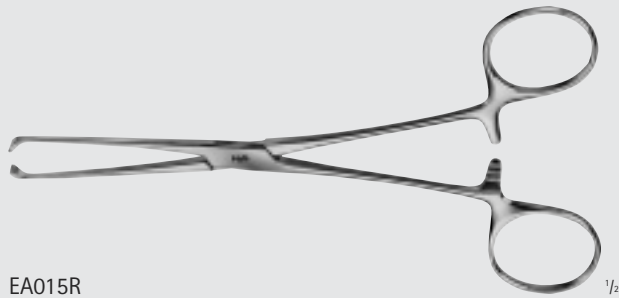

EA015R

1/2

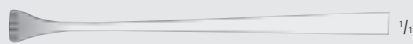

1/4

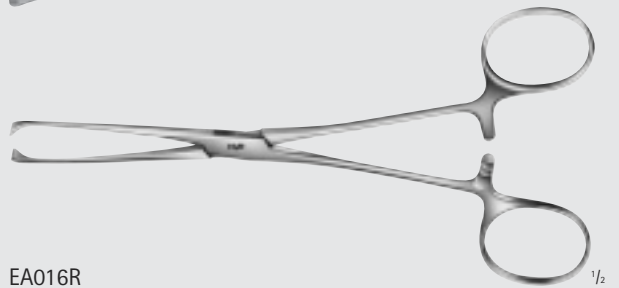

EA016R

1/2

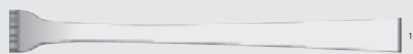

1/4

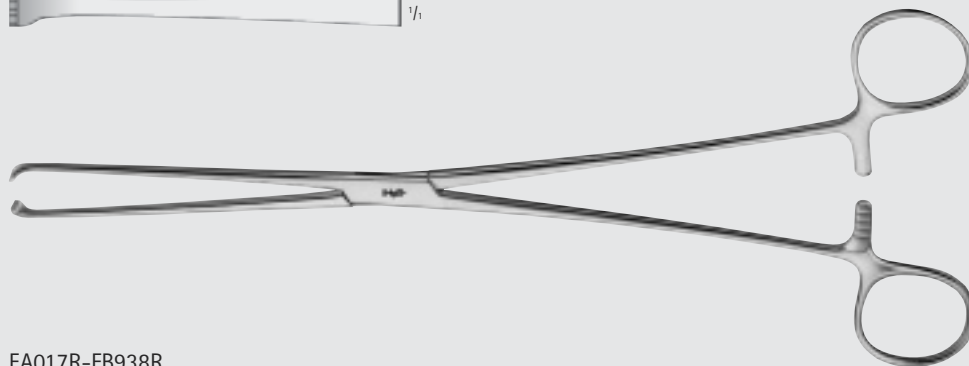

EA017R-FB938R

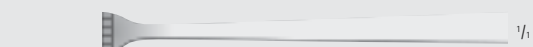

1/4

EA017R

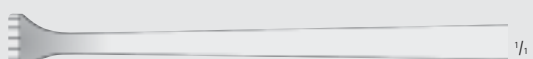

1/4

FB938R

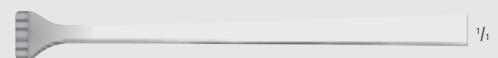

EA018R



INCHES

General Surgery

Abdominal & Intestinal Grasping Forceps

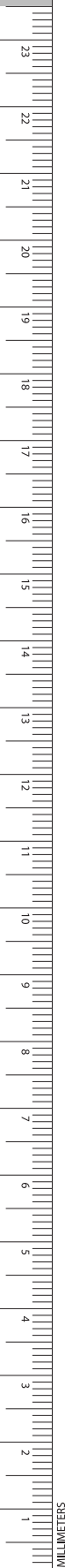

EA020R $\frac{1}{2}$

$\frac{1}{4}$

ALLIS-THOMS Forceps

Catalog Number	Teeth	Length (in.)
EA020R	6 x 7	8

EA025R-EA026R

EA025R $\frac{1}{4}$

EA026R $\frac{1}{4}$

JUDD-ALLIS Forceps

Catalog Number	Teeth	Length (in.)
EA025R	3 x 4	6
EA026R	3 x 4	7 3/4

MD568 $\frac{1}{2}$

$\frac{1}{4}$

ALLIS-ADAIR Clamp

Catalog Number	Teeth	Length (in.)
MD568	9 x 10	6 1/4

General Surgery

Abdominal & Intestinal Grasping Forceps

GENL

ALLIS Atraumatic Forceps

Catalog Number	Length (in.)
EA092R	6
EA095R	8
EA096R	8 3/4
EA097R	10
EA099R	12
EA100R	11 3/4
EA101R	14

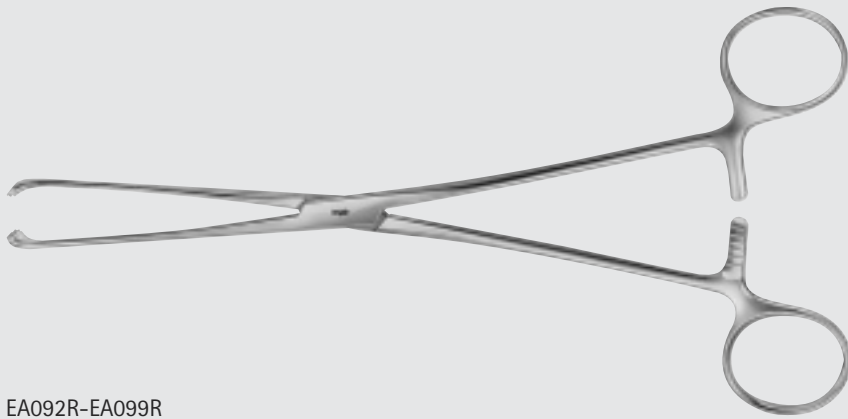

EA092R-EA099R

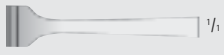

EA092R

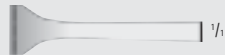

EA095R



EA096R

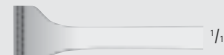

EA097R

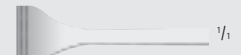

EA099R



EA100R-EA101R

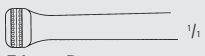

EA100R

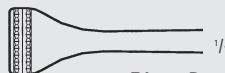

EA101R

BABCOCK Forceps

Catalog Number	Length (in.)
EA030R	6
EA031R	6 3/4
EA032R	8 1/2



EA030R-EA032R



EA030R

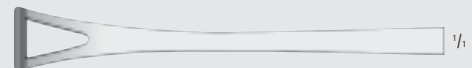

EA031R

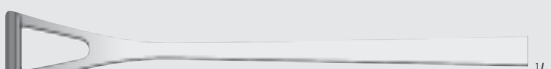

EA032R



INCHES

General Surgery

Abdominal & Intestinal Grasping Forceps

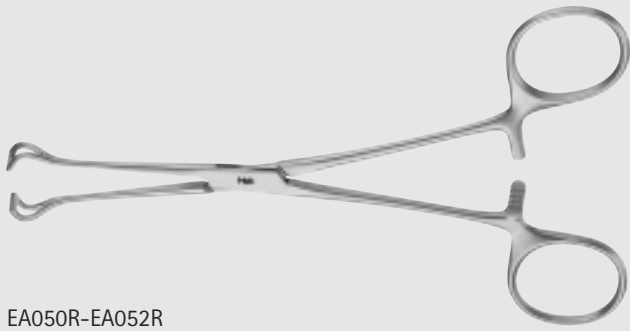
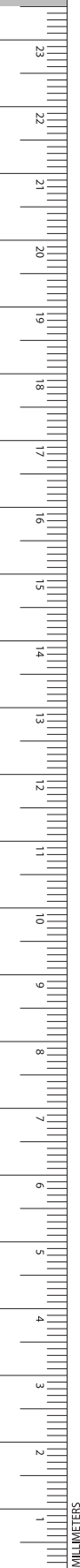

EA050R-EA052R

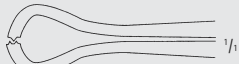

EA050R



EA052R



BABCOCK Atraumatic Forceps

Catalog Number	Length (in.)
EA050R	6 1/4
EA052R	8 1/2
FB936R	8 3/4

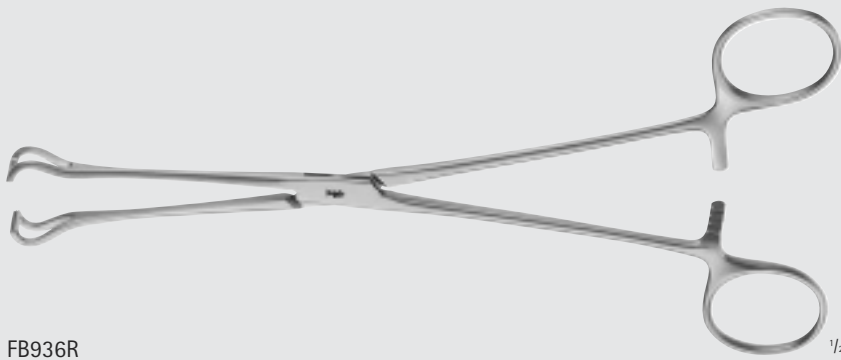

FB936R

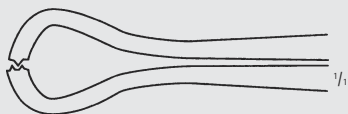

General Surgery
Abdominal & Intestinal Grasping Forceps

GENL

BABCOCK Atraumatic Forceps
(continued)

Catalog Number	Length (in.)
MD470	9 1/2

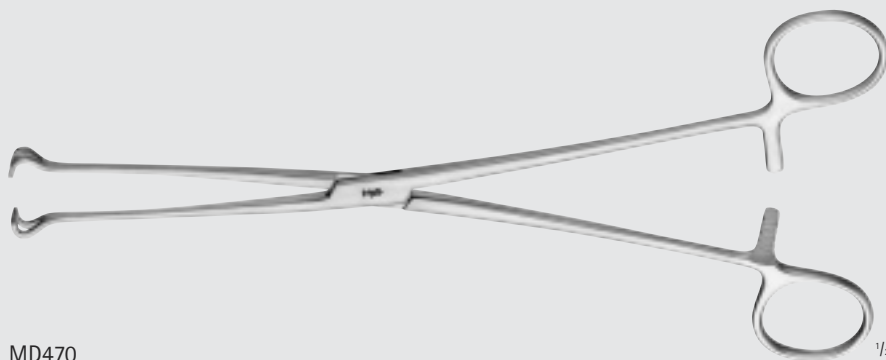

MD470



DUROGRIP TC BABCOCK Forceps

Catalog Number	Length (in.)
MB338R	8 1/4

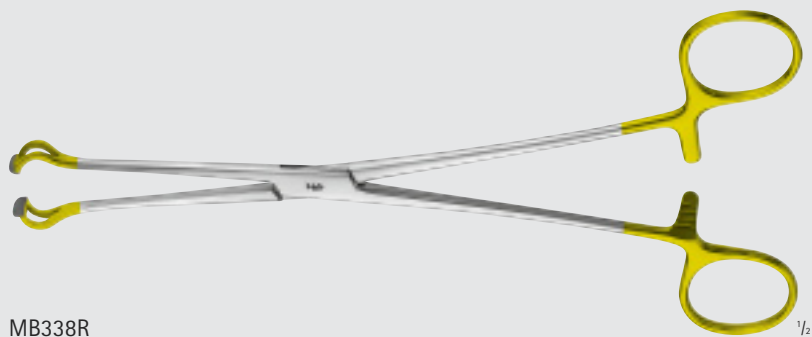

MB338R



INCHES

General Surgery

Abdominal & Intestinal Grasping Forceps

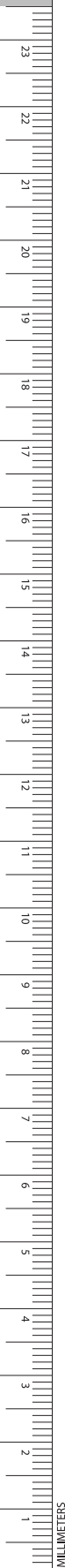

BABCOCK Forceps

Catalog Number	Length (in.)
FB934R	8 3/4
MB300R	14

FB934R $\frac{1}{2}$

$\frac{1}{4}$

KLEINE Forceps

Catalog Number	Length (in.)
FB281R	9

FB281R $\frac{1}{2}$

9 mm $\frac{1}{4}$

BABCOCK Tissue Holding Forceps

Catalog Number	Length (in.)
MB136R	12
MB137R	14

MB136R-MB137R $\frac{1}{2}$

MB136R $\frac{1}{4}$

MB137R $\frac{1}{4}$

COLLIN Intestinal Forceps

Catalog Number	Length (in.)
EA039R	5 1/2
EA040R	7

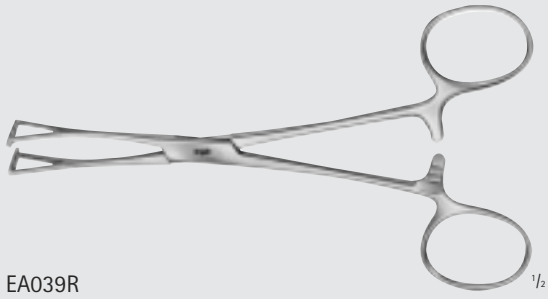

EA039R

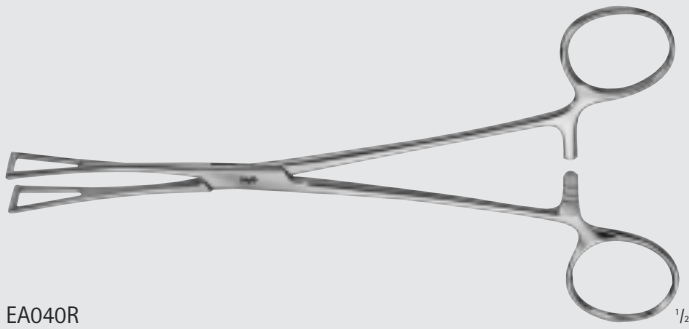
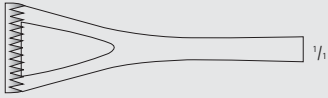

EA040R



COLLIN Atraumatic Forceps

Catalog Number	Length (in.)
EA061R	7 3/4
EA062R	9

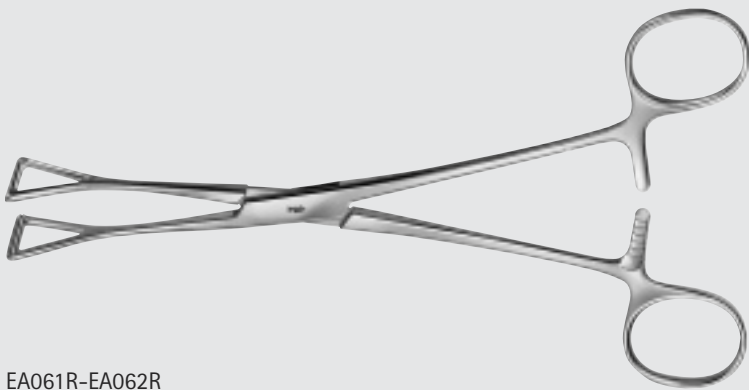

EA061R-EA062R

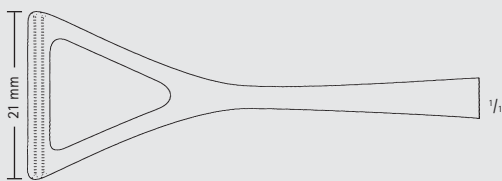

EA061R

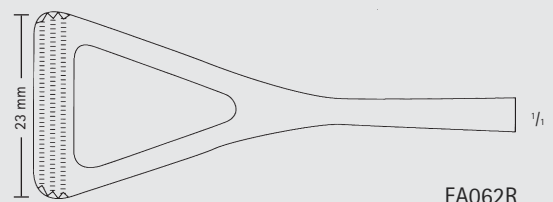

EA062R



INCHES

General Surgery

Abdominal & Intestinal Grasping Forceps

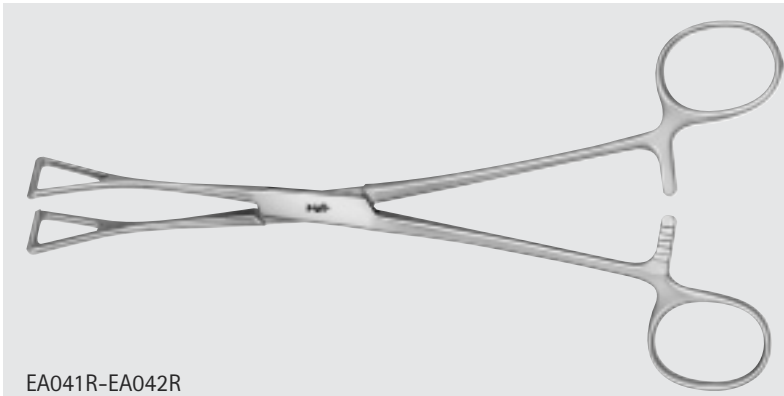
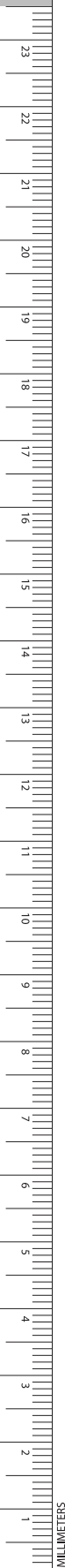

EA041R-EA042R

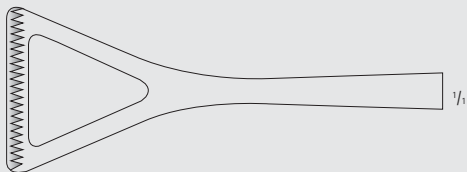

EA041R

DUVAL-COLLIN Intestinal Forceps

Catalog Number	Length (in.)
EA041R	7 3/4
EA042R	8

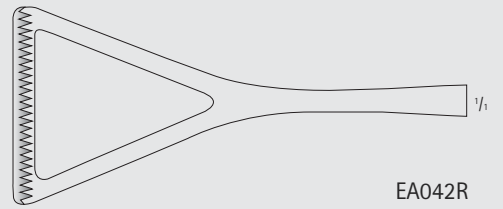

EA042R



BH902R

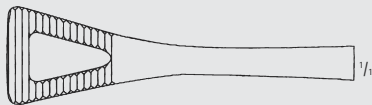

PENNINGTON Forceps

Catalog Number	Length (in.)
BH902R	6
EA037R	8

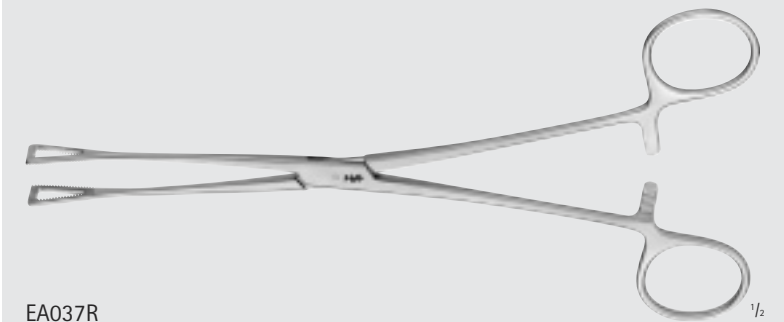

EA037R

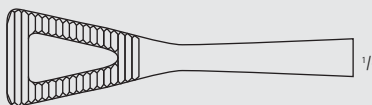

BAINBRIDGE Intestinal Forceps

Catalog Number	Jaw	Length (in.)
EA106R	STR	6
EA107R	CVD	6

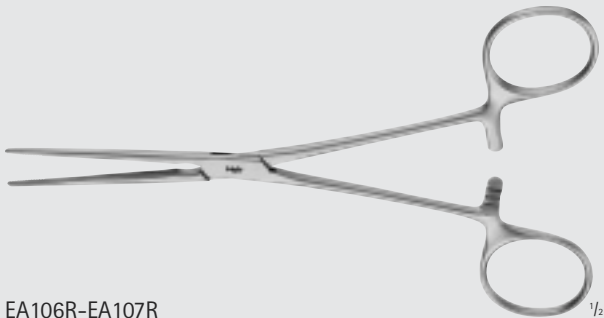

EA106R-EA107R



EA106R



EA107R

ALLEN Intestinal Forceps

Catalog Number	Length (in.)
EA114R	6

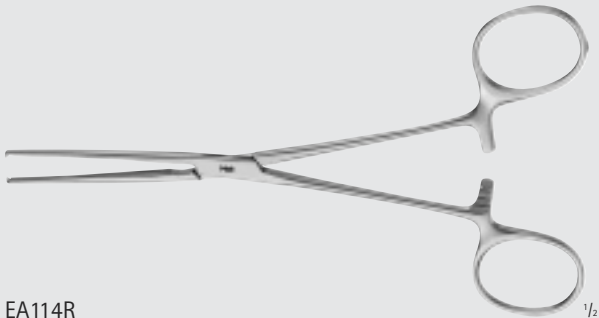

EA114R



ALLEN Intestinal Forceps

Catalog Number	Length (in.)
MB609R	8

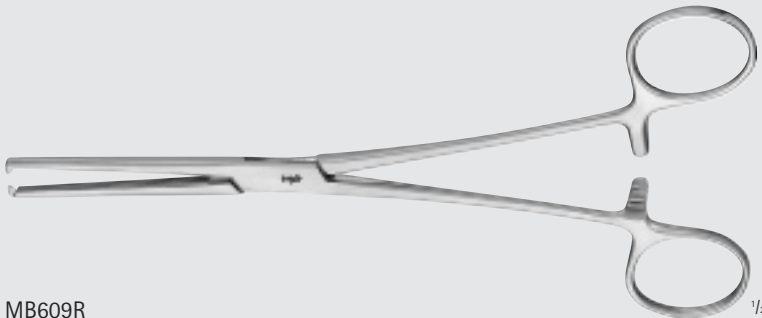

MB609R



1/2



General Surgery

Abdominal & Intestinal Forceps

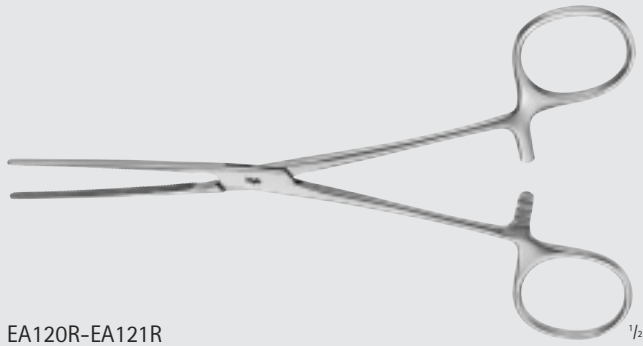

EA120R-EA121R



EA120R



EA121R



EA126R-EA127R



EA126R

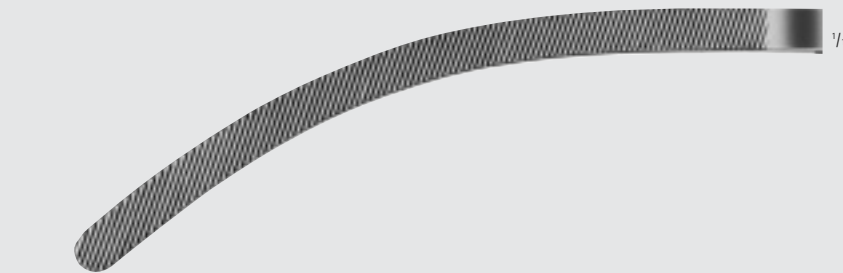

EA127R

DOYEN Intestinal Forceps, Elastic Blades

Catalog Number	Jaw	Length (in.)
EA120R	STR	6 1/2
EA121R	CVD	6 1/2
EA126R	STR	9 1/4
EA127R	CVD	9 1/4

**HARTMANN Intestinal Clamps,
Elastic Blades**

Catalog Number	Jaw	Length (in.)
EA124R	STR	8
EA125R	CVD	8

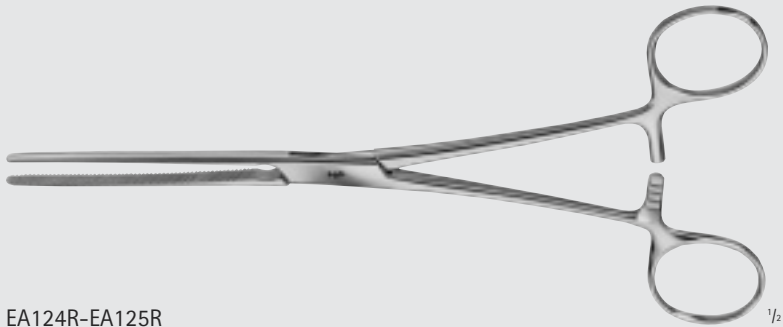

EA124R-EA125R



EA124R

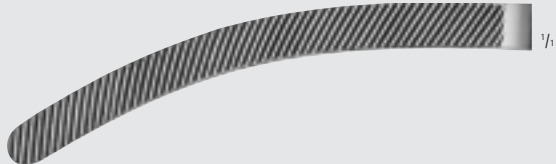

EA125R

**DOYEN Intestinal Forceps, Elastic
Blades**

Catalog Number	Jaw	Length (in.)
EA130R	STR	9 1/2
EA131R	CVD	9 1/2

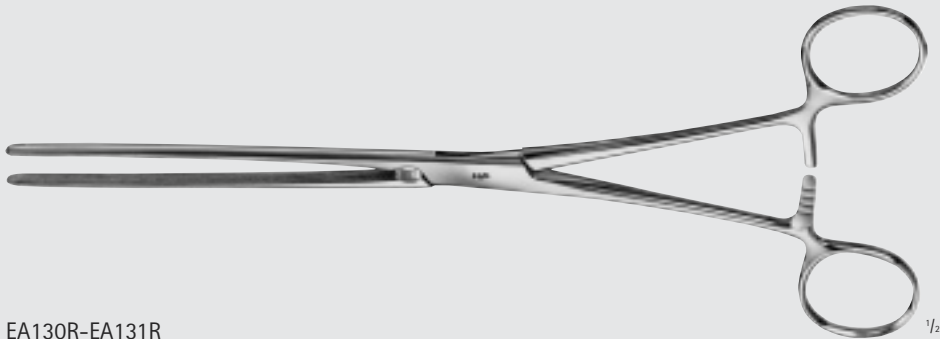

EA130R-EA131R



EA130R

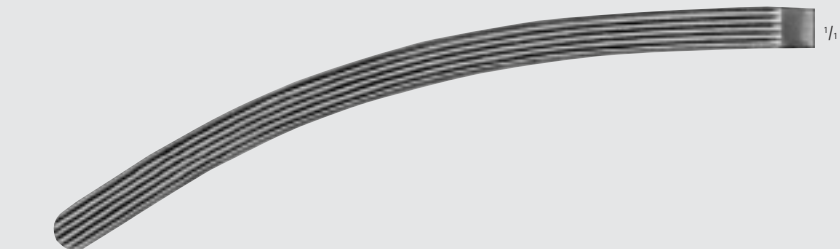

EA131R



INCHES

General Surgery

Abdominal & Intestinal Forceps

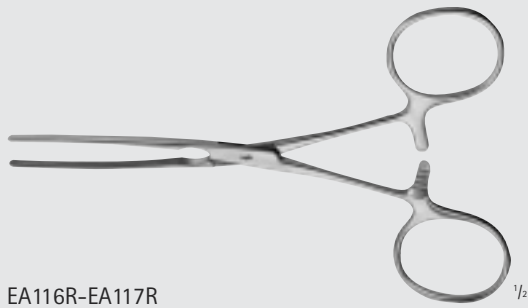

EA116R-EA117R



EA116R

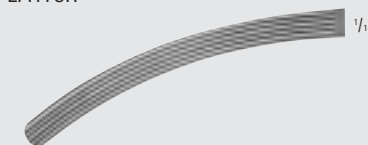

EA117R

BABY-KOCHER Intestinal Forceps, Elastic Blades

Catalog Number	Jaw	Length (in.)
EA116R	STR	5 1/8
EA117R	CVD	5 1/8

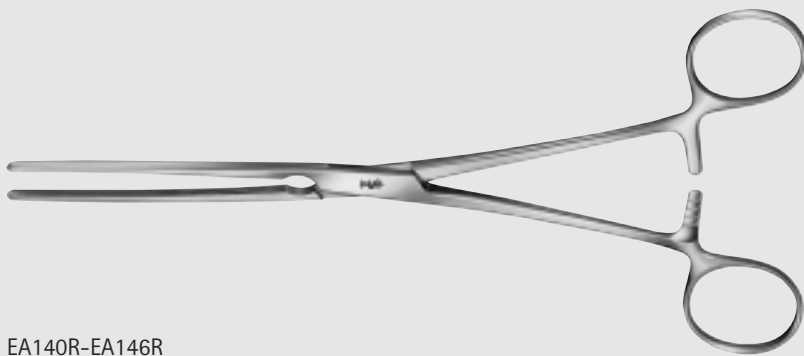

EA140R-EA146R



EA140R

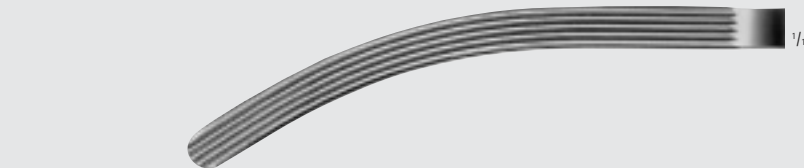

EA141R



EA145R

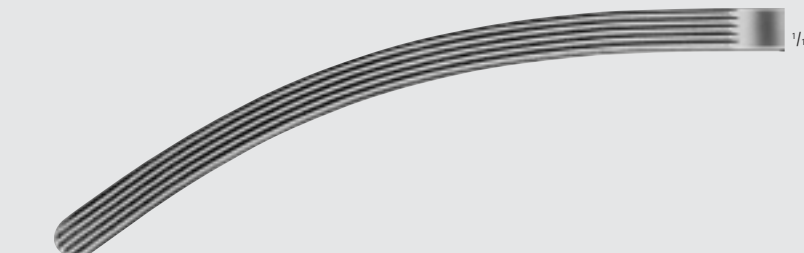

EA146R

KOCHER Intestinal Forceps, Elastic Blades

Catalog Number	Jaw	Length (in.)
EA140R	STR	8 1/4
EA141R	CVD	8 1/4
EA145R	STR	9
EA146R	CVD	9

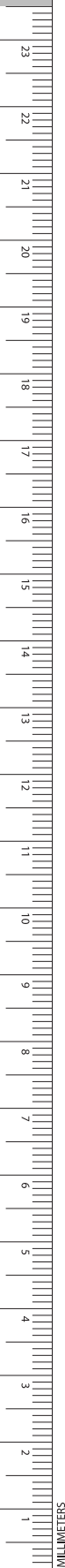

KOCHER Intestinal Forceps, Elastic Blades

Catalog Number	Jaw	Length (in.)
EA150R	STR	8 3/4
EA151R	STR	10
EA152R	STR	11
EA155R	CVD	8 3/4
EA156R	CVD	10

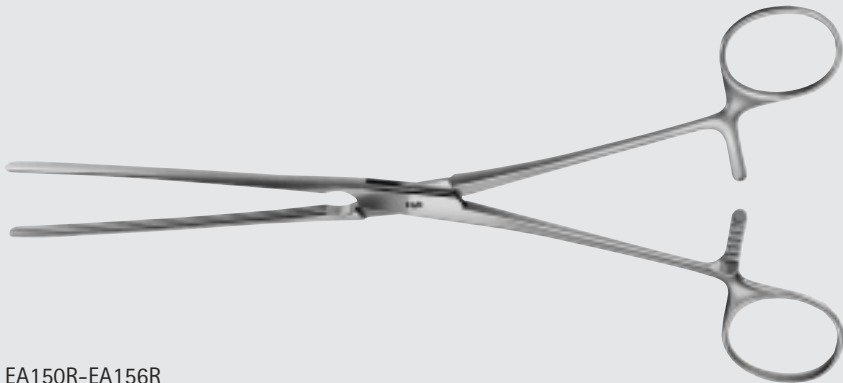

EA150R-EA156R



EA150R



EA151R



EA152R



EA155R



EA156R



INCHES

General Surgery

Abdominal & Intestinal Forceps

MAYO-ROBSON Intestinal Forceps,
Hard Elastic Blades

Catalog Number	Jaw	Length (in.)
EA170R	STR	10
EA171R	CVD	10

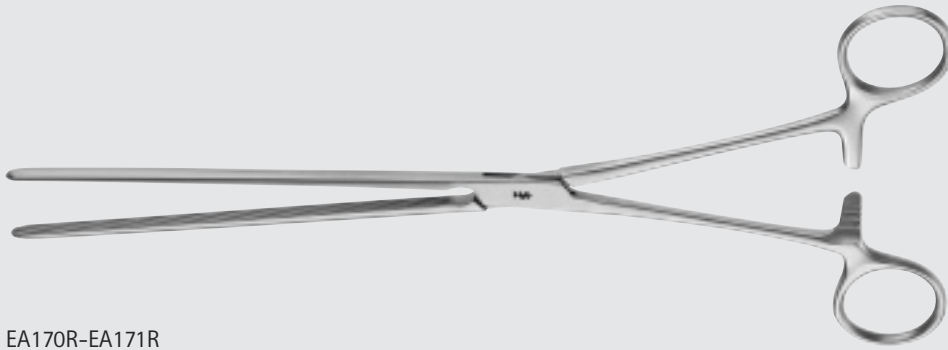

EA170R-EA171R



EA170R

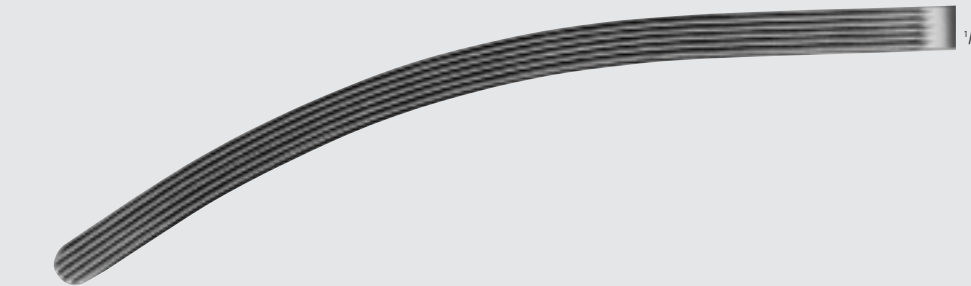

EA171R

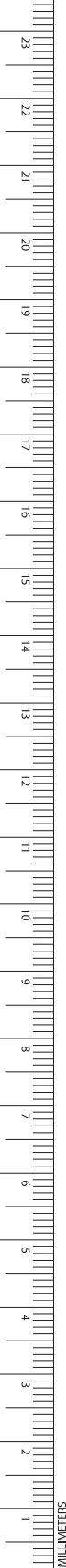

General Surgery
Abdominal & Intestinal Forceps

GENL



EA305R-EA309R

PAYR Intestinal Clamp

Catalog Number	Length (in.)
EA305R	7
EA306R	8
EA309R	10 3/4

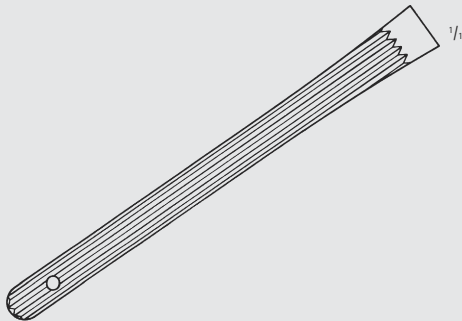

EA305R

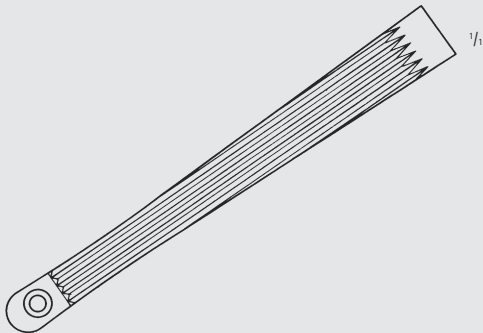

EA306R

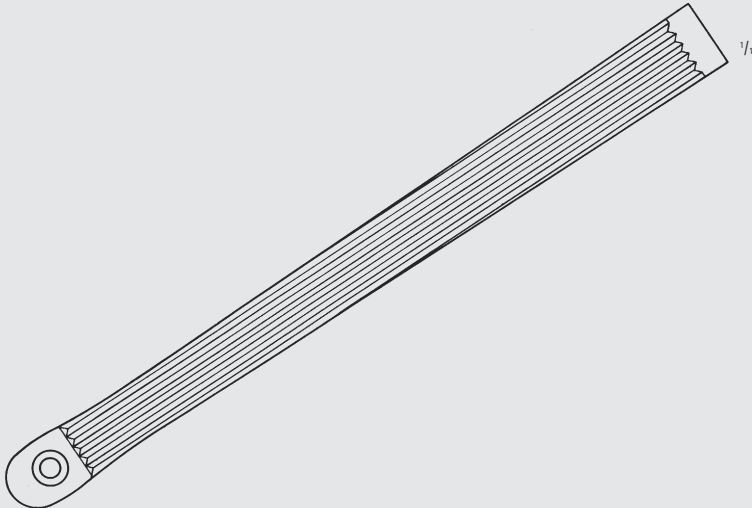

EA309R



INCHES

General Surgery

Abdominal & Intestinal Forceps

PAYR Pylorus Intestinal Clamp

Catalog Number	Length (in.)
EA450R	12 1/2

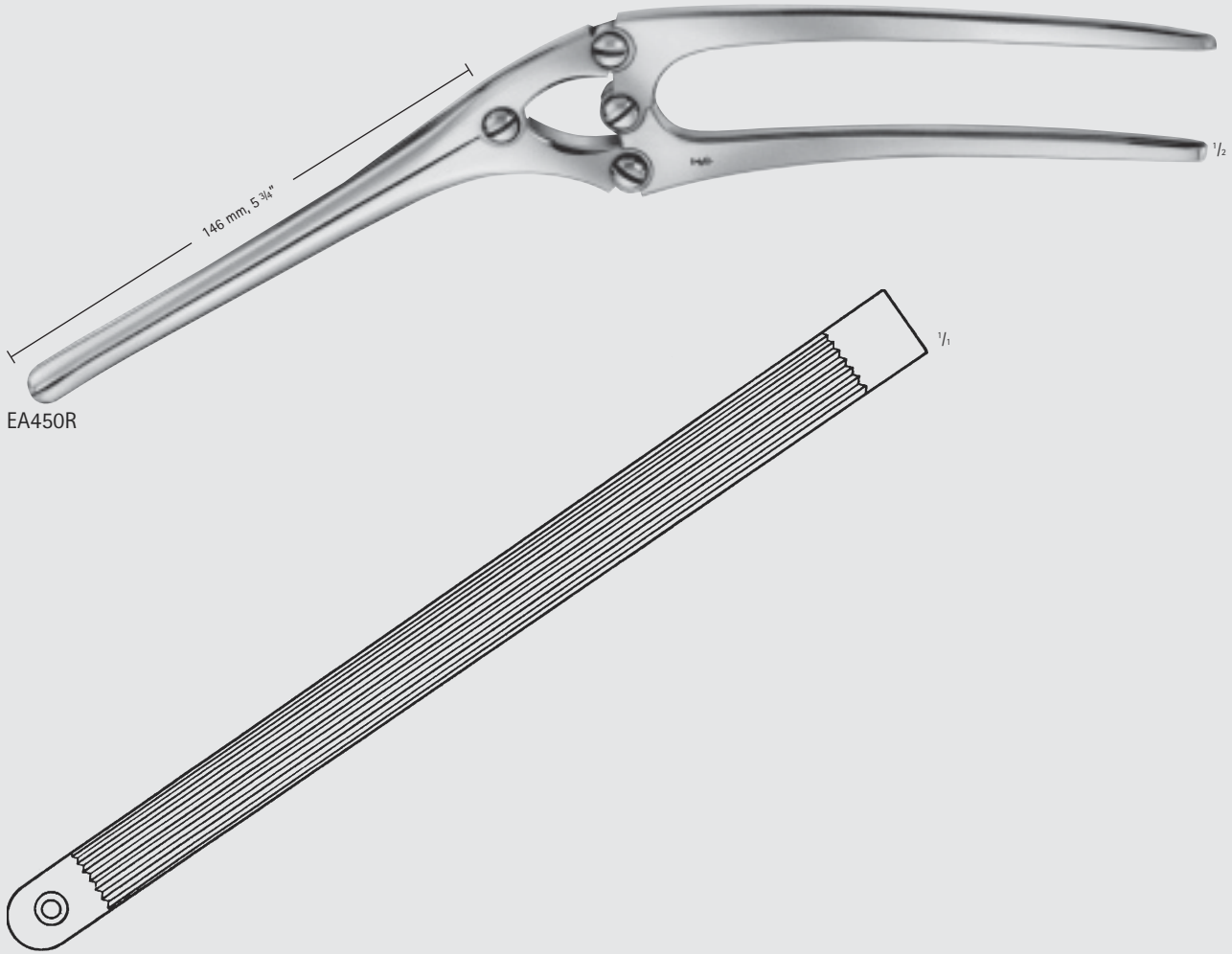

KLEINSCHMIDT Forceps

Catalog Number	Jaw	Length (in.)
EA397R	CVD	5 1/8

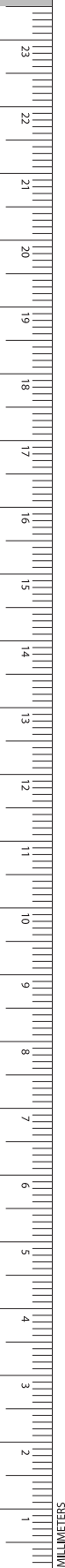



BENSON Pylorus Spreader

Catalog Number	Length (in.)
EA466R	6

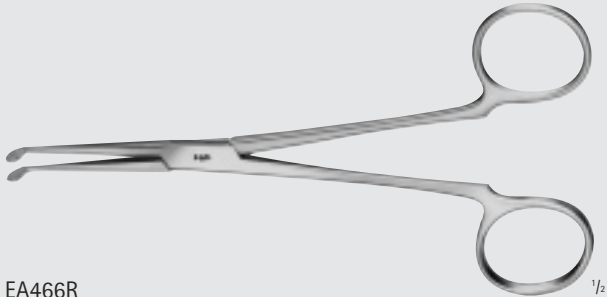

EA466R

1/2



1/2

MC GIVNEY Hemorrhoidal Forceps

Catalog Number	Length (in.)
EA990R	7 1/4

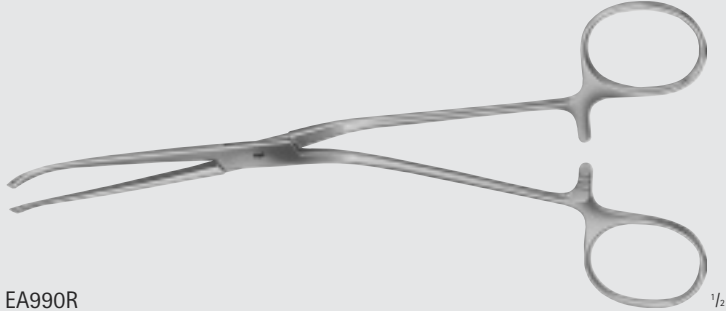

EA990R

1/2

PRATT-SMITH Hemostatic Forceps

Catalog Number	Length (in.)
MD582	6

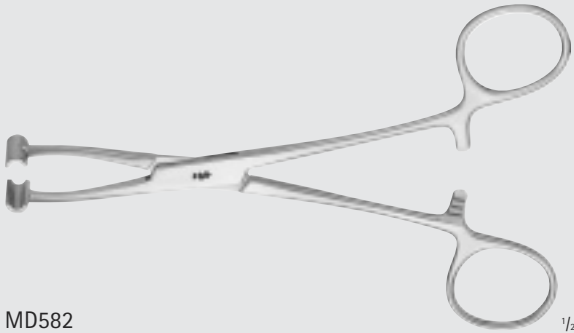

MD582

1/2



1/2

General Surgery

Atraumatic Intestinal Forceps & Clamps

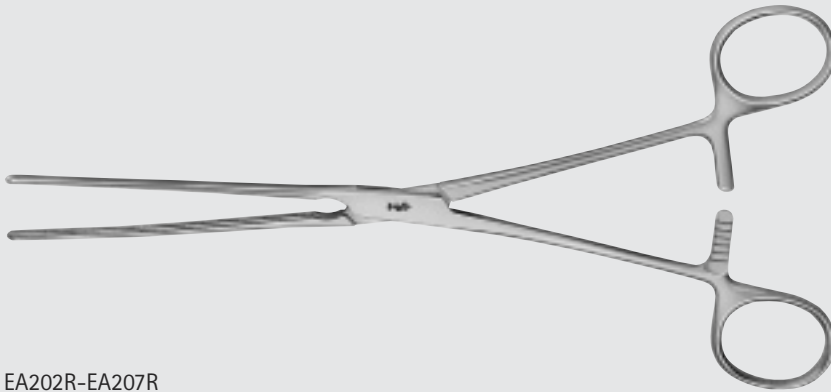

**KOCHER Atraumatic Forceps,
Elastic Blades**

Catalog Number	Jaw	Length (in.)
EA202R	STR	8 3/4
EA203R	CVD	8 3/4
EA204R	STR	10
EA205R	CVD	10
EA206R	STR	11
EA207R	CVD	11

EA202R-EA207R

EA202R



1/4

EA203R



1/4

EA204R



1/4

EA205R



1/4

EA206R



1/4

EA207R



1/4

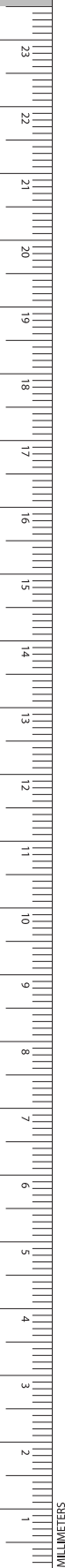

**HARTMANN Atraumatic Forceps,
Elastic Blades**

Catalog Number	Jaw	Length (in.)
EA210R	STR	8
EA211R	CVD	8

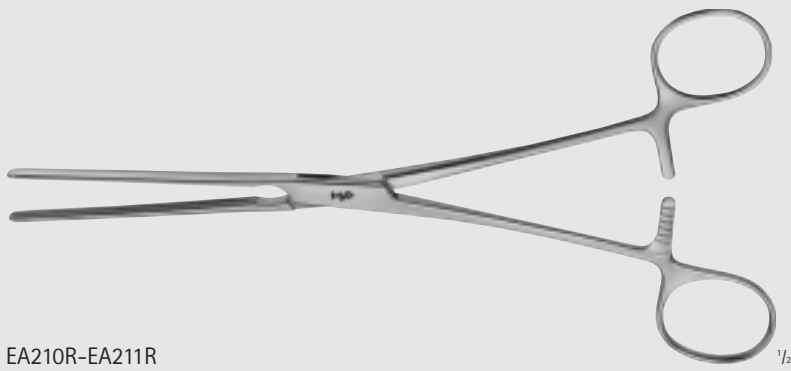

EA210R-EA211R



EA210R

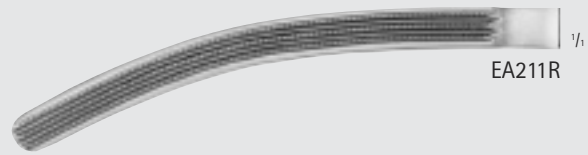

EA211R

MAYO-ROBSON Atraumatic Forceps

Catalog Number	Jaw	Length (in.)
EA216R	STR	10
EA217R	CVD	10

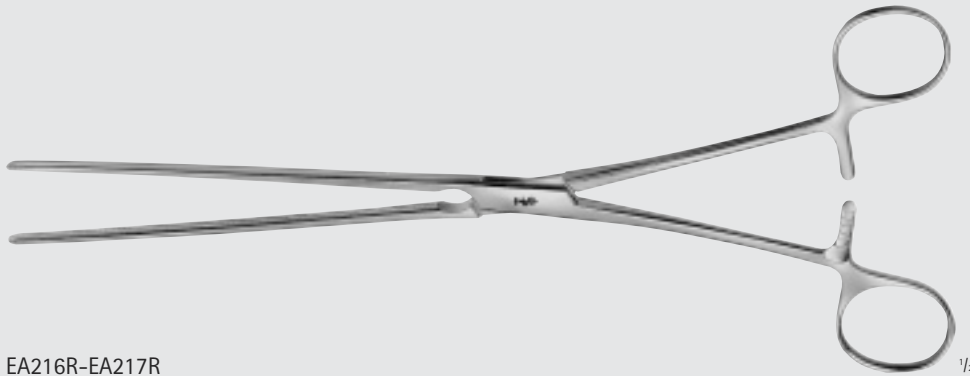

EA216R-EA217R



EA216R

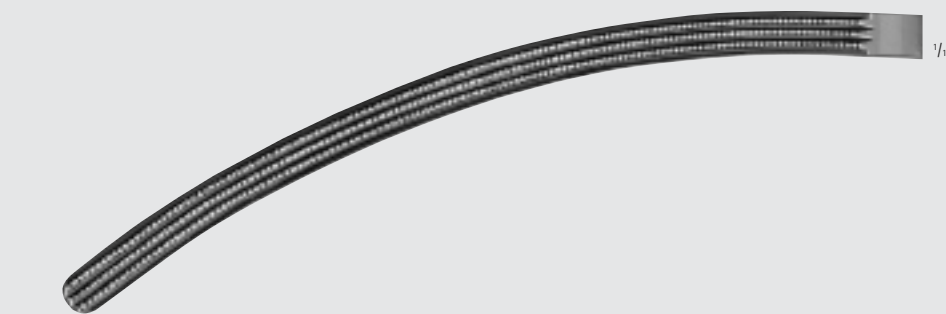

EA217R



INCHES

General Surgery

Atraumatic Intestinal Forceps & Clamps

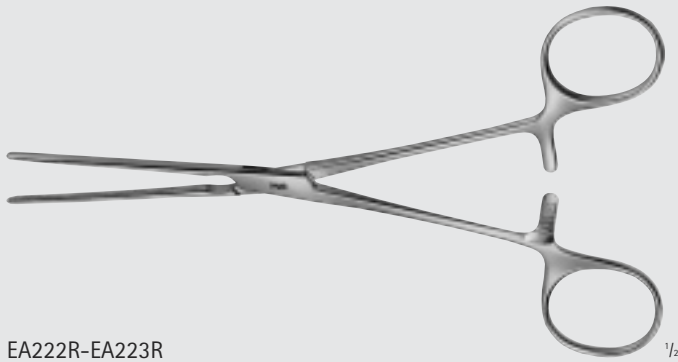
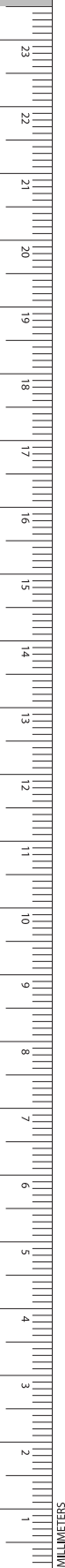

EA222R-EA223R



EA222R



EA223R

DOYEN Atraumatic Forceps, Elastic Blades

Catalog Number	Jaw	Length (in.)
EA222R	STR	6 3/4
EA223R	CVD	6 3/4

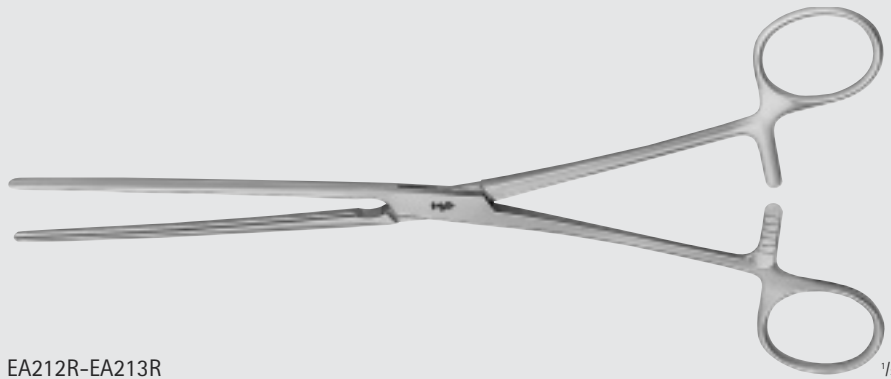

EA212R-EA213R



EA212R



EA213R

DOYEN Atraumatic Forceps, Long, Elastic Blades

Catalog Number	Jaw	Length (in.)
EA212R	STR	9
EA213R	CVD	9

General Surgery

Atraumatic Intestinal Forceps & Clamps

GENL

SCUDDER Atraumatic Forceps

Catalog Number	Jaw	Length (in.)
EA240R	STR	13

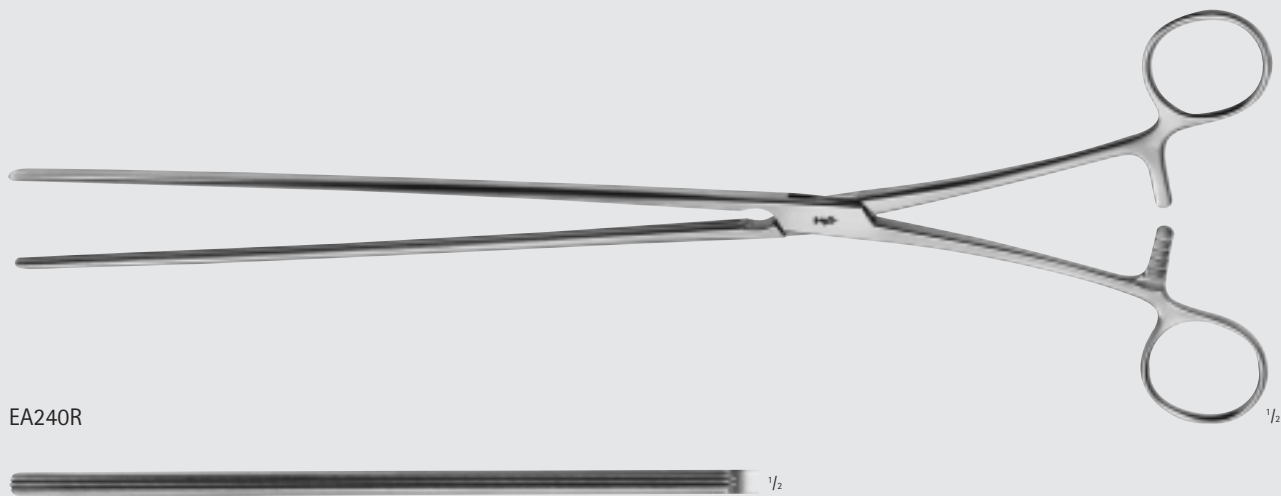

GLASSMAN Anterior Resection Clamps

Catalog Number	Jaw	Length (in.)
MB130R	90°, SERR	9 3/4

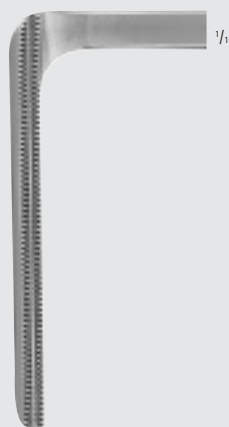

INCHES

General Surgery

Dressing & Sponge Forceps

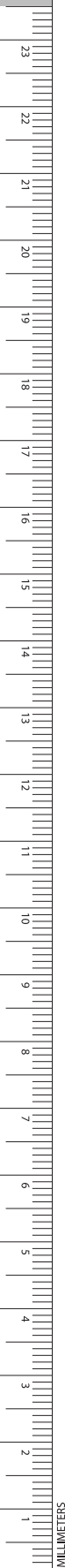
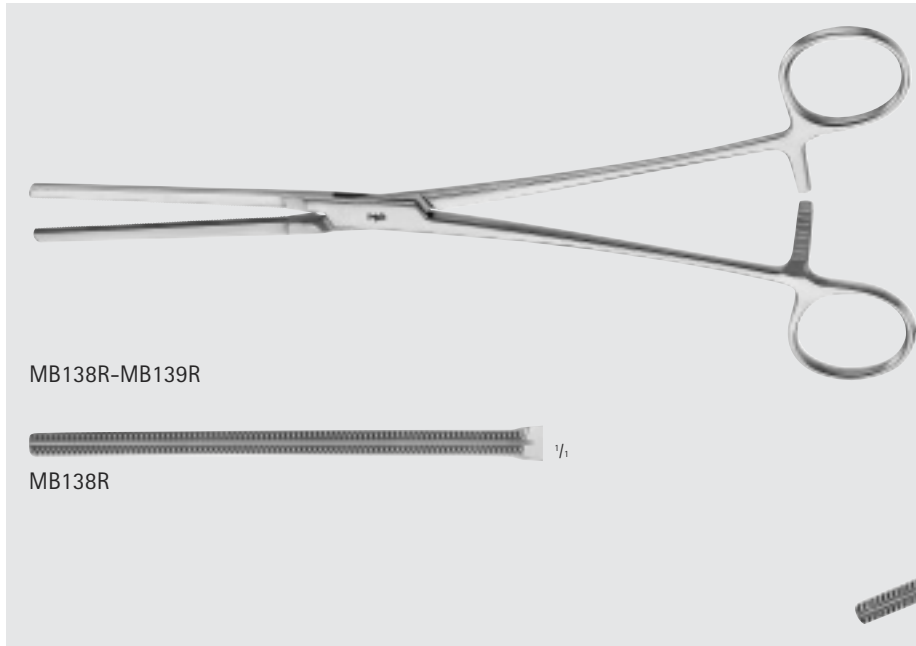
GLASSMAN Non-Crushing Gastrointestinal Clamps

Catalog Number	Jaw	Length (in.)
MB138R	STR	9 1/4
MB139R	ANG	9

MB138R-MB139R

MB138R

MB139R

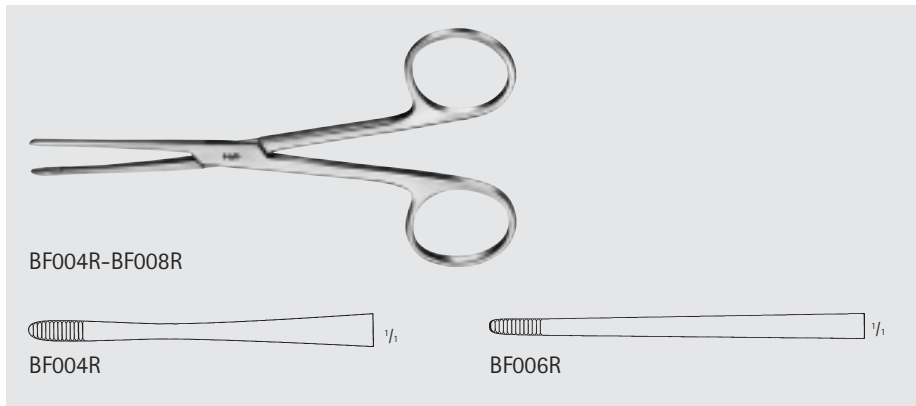

LISTER Sponge Forceps

Catalog Number	Jaw	Length (in.)
BF004R	STR	5 1/8
BF006R	STR	6 1/4
BF008R	STR	7

BF004R-BF008R

BF004R

BF006R

BF008R

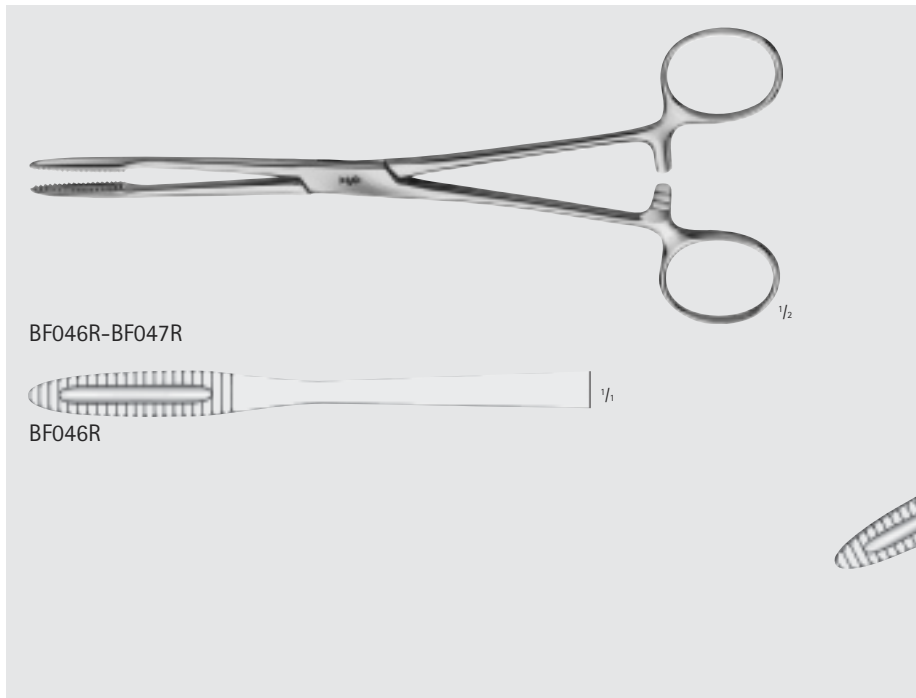

GROSS Forceps, W/Ratchet

Catalog Number	Jaw	Length (in.)
BF046R	STR	8
BF047R	CVD	8

BF046R-BF047R

BF046R

BF047R

SIMS-MAIER Sponge Forceps

Catalog Number	Jaw	Length (in.)
BF078R	STR	14

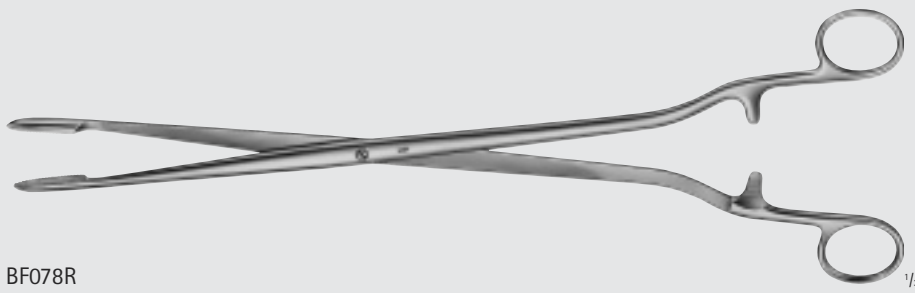

BF078R



ULRICH-AESCLAP Sponge Forceps

Catalog Number	Jaw	Length (in.)
BF062R	STR	10 1/2
BF063R	CVD	10 1/2
BF065R	CVD	14

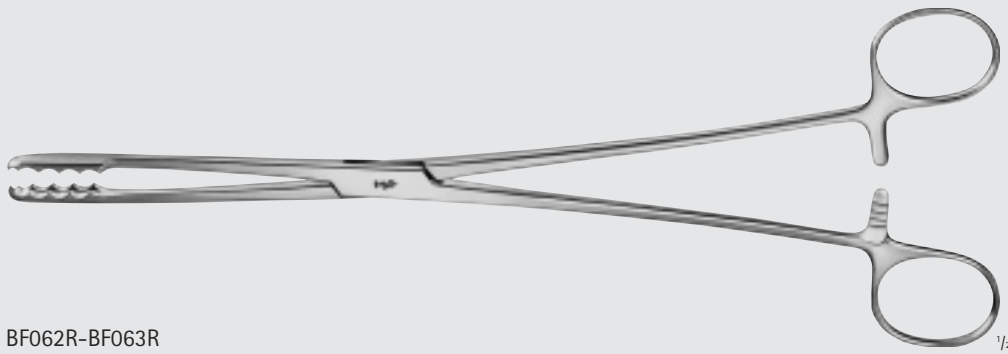

BF062R-BF063R



BF062R



BF063R



BF065R



INCHES

General Surgery

Dressing & Sponge Forceps

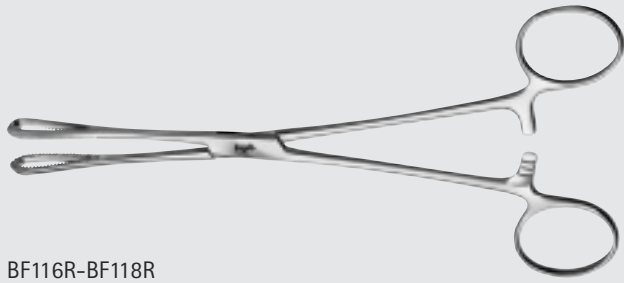
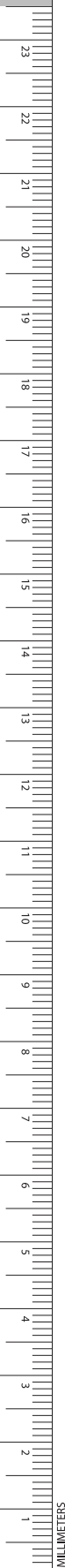

BF116R-BF118R

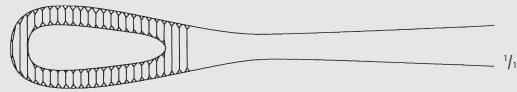

BF116R

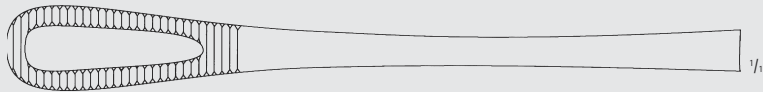

BF118R

RAMPLEY Sponge Forceps

Catalog Number	Tip	Jaw	Length (in.)
BF116R	SERR	STR	7
BF118R	SERR	STR	10

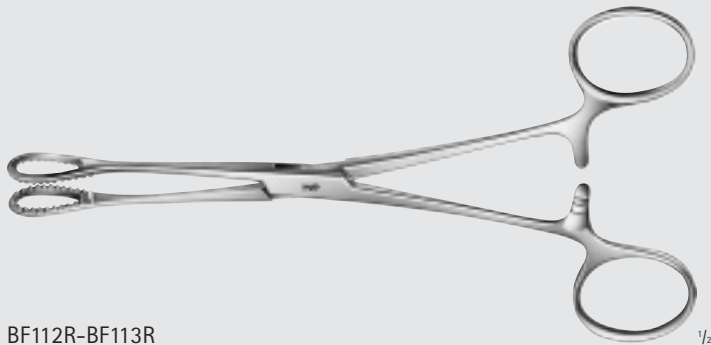

BF112R-BF113R

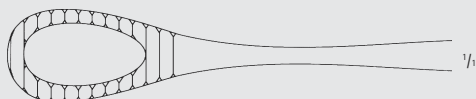

BF112R



BF113R

FOERSTER-BALLENGER Sponge Forceps

Catalog Number	Tip	Jaw	Length (in.)
BF112R	SERR	STR	7
BF113R	SERR	CVD	7

FOERSTER Sponge Forceps

Catalog Number	Tip	Jaw	Length (in.)
MB098R	SERR	STR	12
MB099R	SERR	STR	14

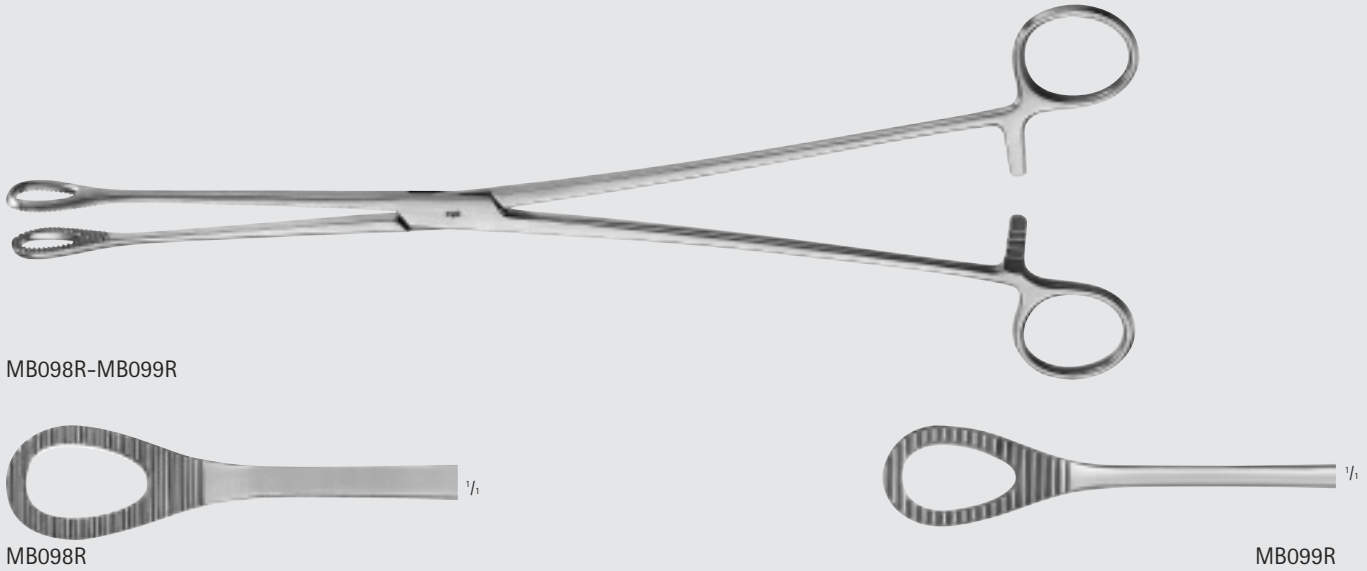

MB098R-MB099R

MB098R

MB099R

FOERSTER-BALLENGER Sponge Forceps

Catalog Number	Tip	Jaw	Length (in.)
BF120R	SMOOTH	STR	9 3/4
BF121R	SMOOTH	CVD	9 3/4
BF122R	SERR	STR	9 3/4
BF123R	SERR	CVD	9 3/4

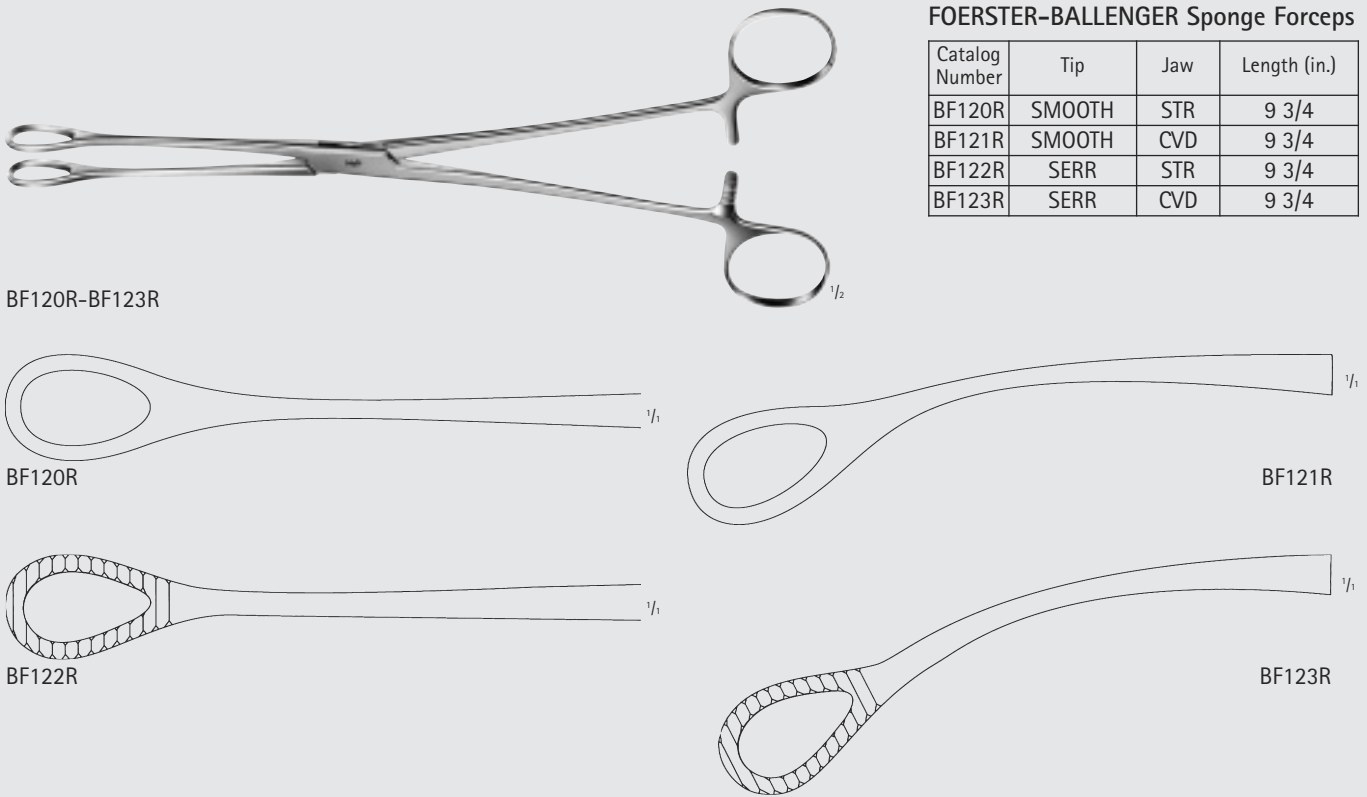

BF120R-BF123R

BF120R

BF121R

BF122R

BF123R

General Surgery

Dressing & Sponge Forceps

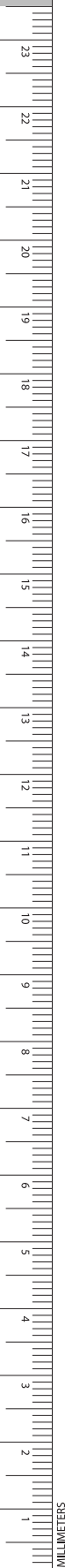

MB232 1/2

BALLENGER Sponge Forceps

Catalog Number	Tip	Jaw	Length (in.)
MB232	SMOOTH	STR	7

1/2

BH906R-BH908R 1/2

COLLIN Forceps W/Screw

Catalog Number	Jaw	Length (in.)
BH906R	OVAL	6 1/4
BH908R	TEARDROP	6 1/4

BH906R 1/2

BH908R 1/2

OM485R 1/2

DUPLAY Sponge Forceps

Catalog Number	Length (in.)
OM485R	7 1/2

1/2

KELLY Sponge Forceps

Catalog Number	Tip	Jaw	Handle	Length (in.)
BF135R	SERR	CVD	W/OUT RATCHET	12 3/4
BF136R	SERR	CVD	W/RATCHET	12 3/4

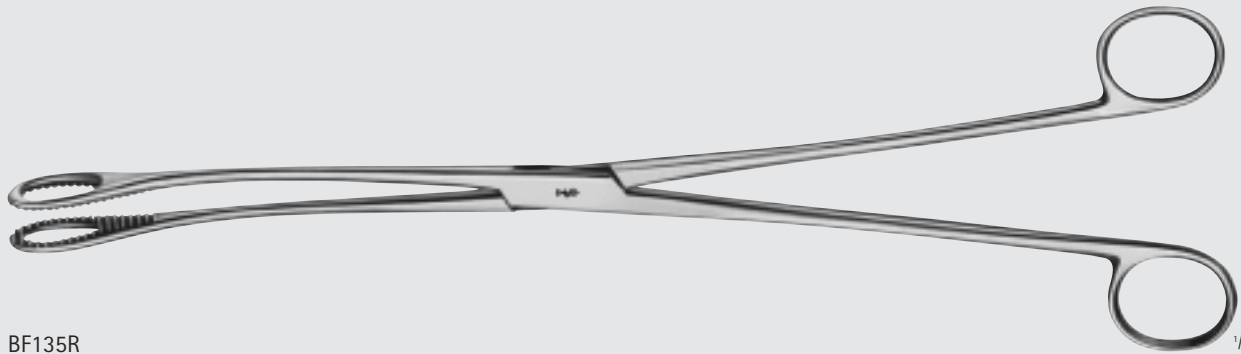

BF135R

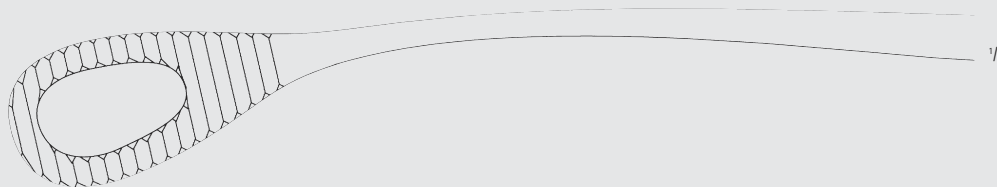

BF135R-BF136R

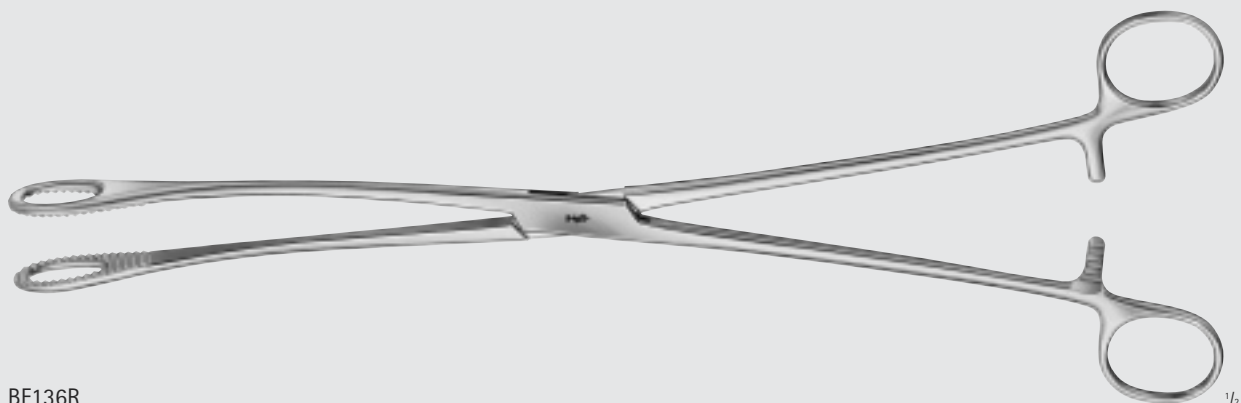

BF136R



General Surgery

Dressing & Sponge Forceps

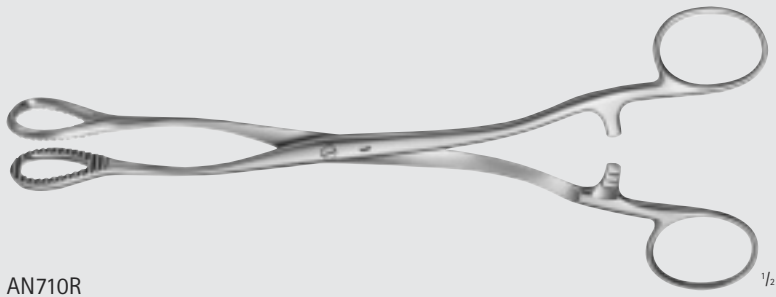
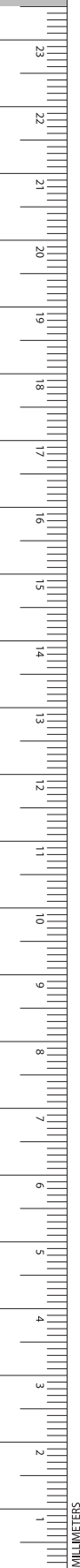

AN710R



AN711R

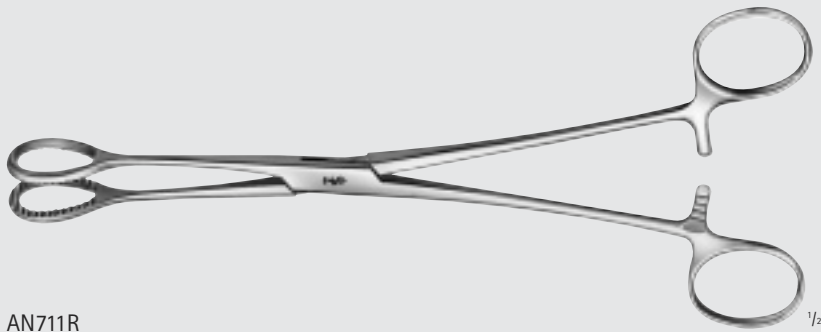

HEYWOOD-SMITH Forceps

Catalog Number	Tip	Length (in.)
AN710R	SERR	8
AN711R	SERR	8 1/2

YEOMAN Rectal Biopsy Forceps

Catalog Number	Tip Size (mm)	Shaft Length (in.)
EA903R	4	16 3/4

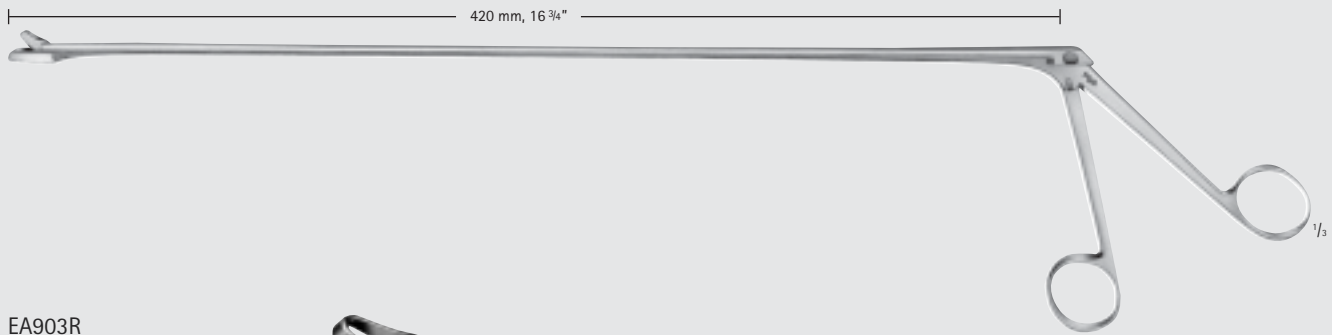

EA903R

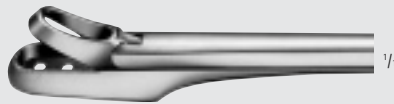
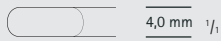

Rectal Biopsy Forceps

Catalog Number	Item	Tip Size (mm)	Jaw	Shaft Length (in.)
EA905R	HANDLE, F/EA907R	-	-	
EA906R	-	3.5	STR	16 3/4
EA907R	-	3.5	CVD	16 3/4

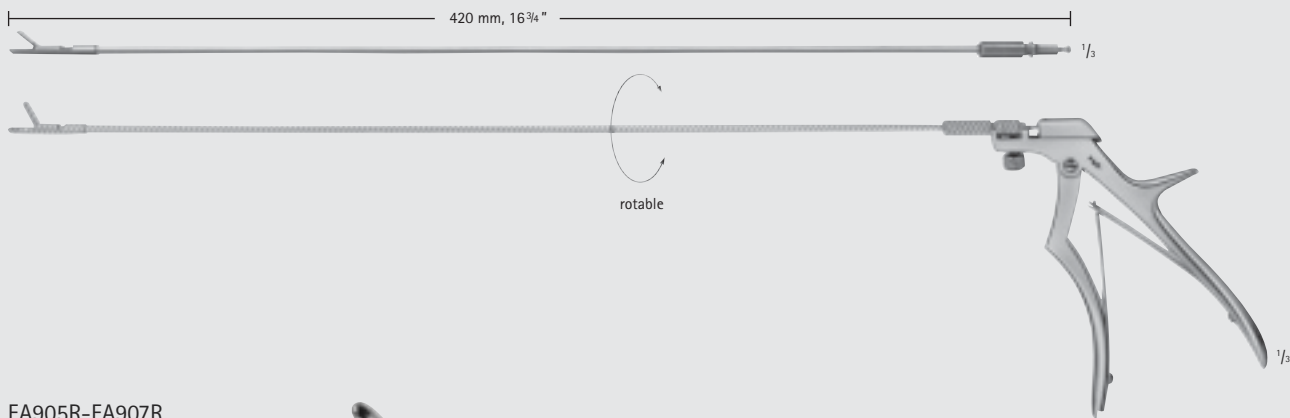

EA905R-EA907R

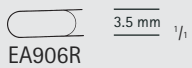

EA906R

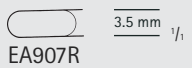

EA907R



General Surgery

Biopsy Forceps



MB200R

PRICE Muscle Biopsy Clamps

Catalog Number	Jaw	Jaw Size (mm)
MB200R	DOUBLE-PRONG	8

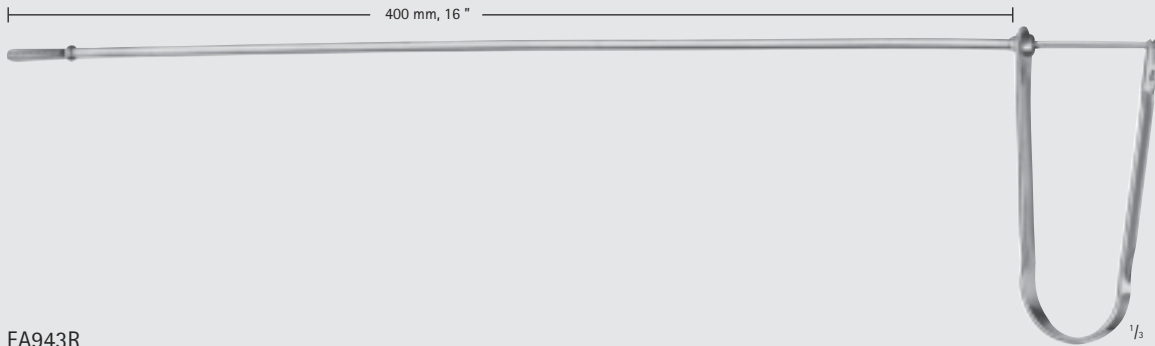

EA943R

AESCULAP Rectal Swab Holder

Catalog Number	Shaft Length (in.)
EA943R	16

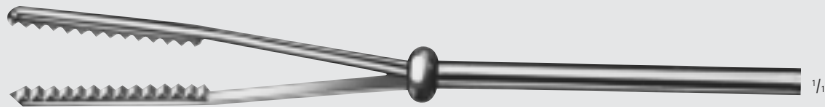

LOWER Gall Duct Forceps

Catalog Number	Jaw	Length (in.)
EB001R	HVY-CVD	7

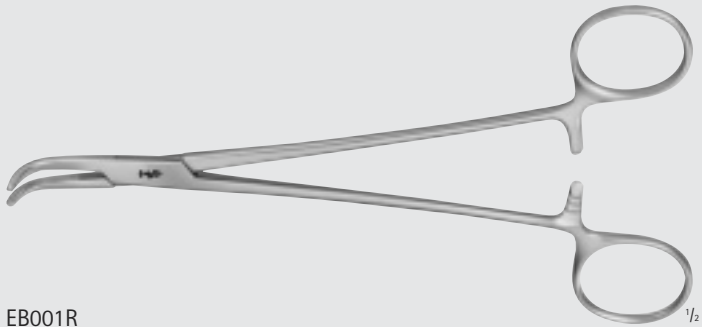

EB001R



LAHEY (SWEET) Gall Duct Forceps

Catalog Number	Jaw	Length (in.)
EB003R	CVD	8

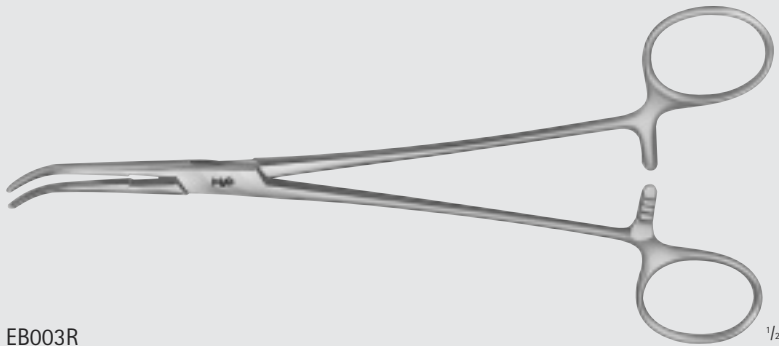

EB003R



DESJARDINS Gall Duct Forceps

Catalog Number	Jaw	Length (in.)
EB008R	HVY-CVD	8 3/4

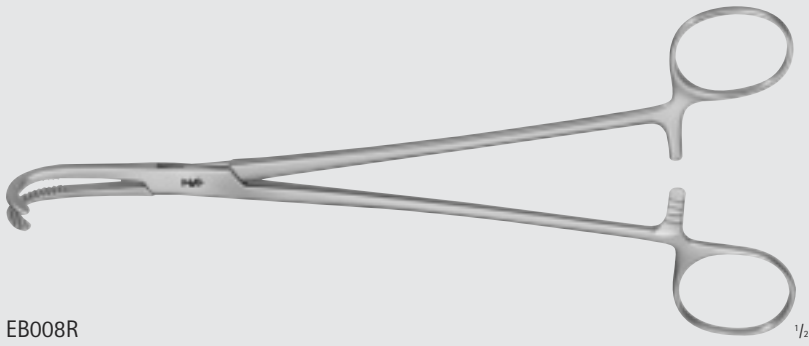



EB008R



INCHES

General Surgery

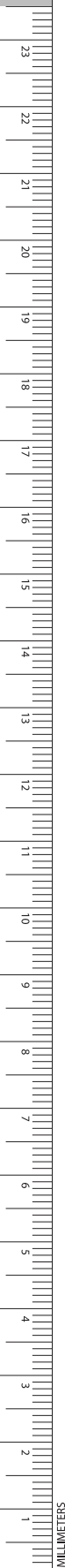
Abdominal & Intestinal Forceps





EB004R 1/2

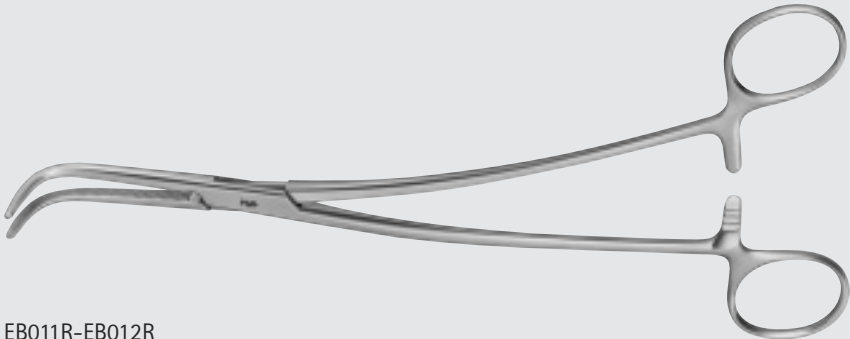

1/2

Catalog Number	Jaw	Length (in.)
EB004R	HVY-CVD	7 1/2



EB011R-EB012R 1/2



EB011R 1/2

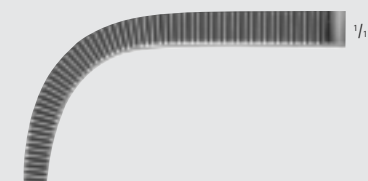

EB012R 1/2

Catalog Number	Jaw	Length (in.)
EB011R	SHORT, CVD	8 3/4
EB012R	LONG, CVD	8 3/4



MIXTER Gall Duct Forceps

Catalog Number	Jaw	Length (in.)
MB120R	HVY-CVD	6 1/4

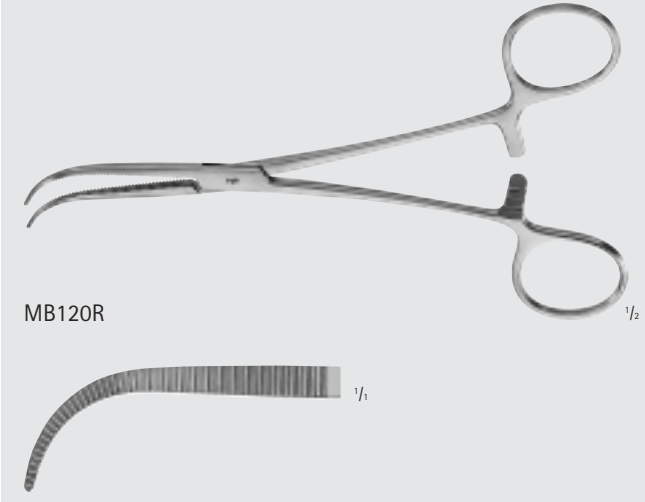

MB120R

1/2

1/4

SHALLCROSS Cystic Duct Forceps

Catalog Number	Jaw	Length (in.)
MB126R	CVD	6 7/8

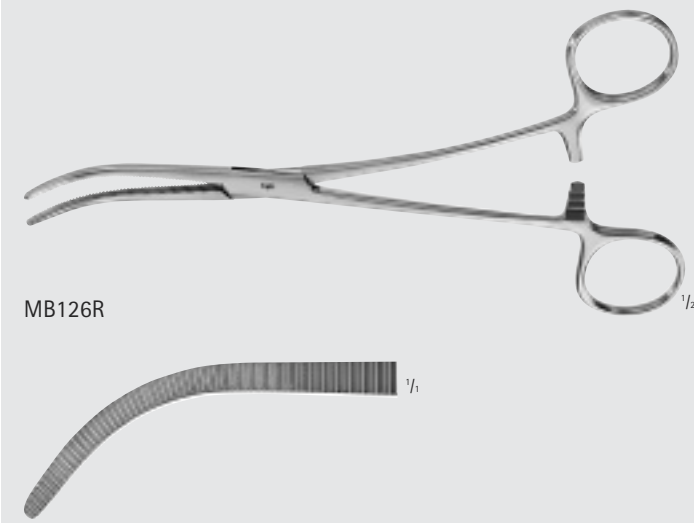

MB126R

1/2

1/4

BLAKE Gall Stone Forceps

Catalog Number	Jaw	Length (in.)
EB220R	STR	8
EB221R	CVD	8

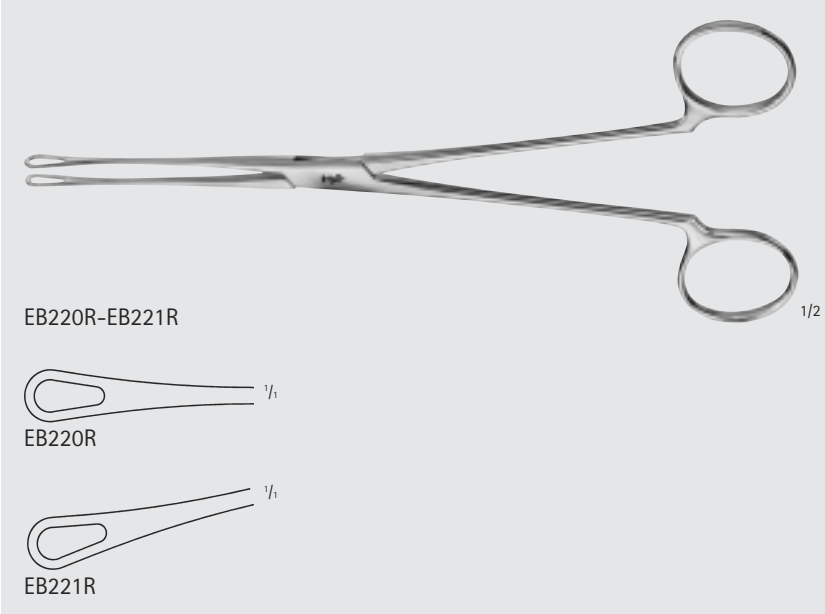

EB220R-EB221R

1/2

EB220R

1/4

EB221R

1/4

General Surgery

Abdominal & Intestinal Forceps



EB231R-EB234R

1/2

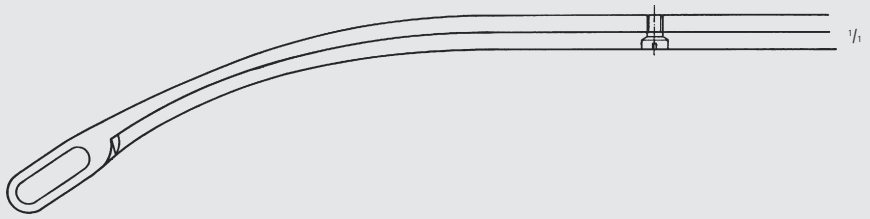

1/4



EB231R

1/4



EB232R

1/4



EB233R

1/4



EB234R

1/4

DESJARDINS Gall Stone Forceps

Catalog Number	Tip	Length (in.)
EB231R	OVAL	9
EB232R	OVAL	9
EB233R	TAPERED	9
EB234R	TAPERED	9

PARKER-KERR Forceps

Catalog Number	Jaw	Length (in.)
EA365R	SLT-CVD	10



HEIMING Kidney Stone Forceps

Catalog Number	Jaw	Length (in.)
EF047R	SLT-CVD	6 3/4
EF048R	HVY-CVD	6 1/4

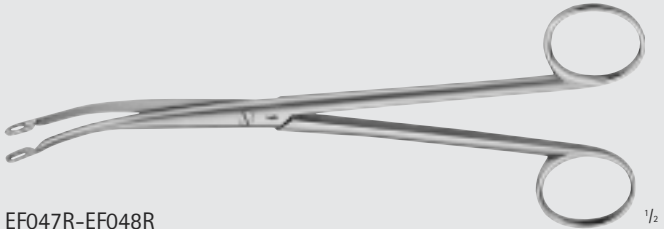

INCHES

General Surgery

Abdominal & Intestinal Forceps

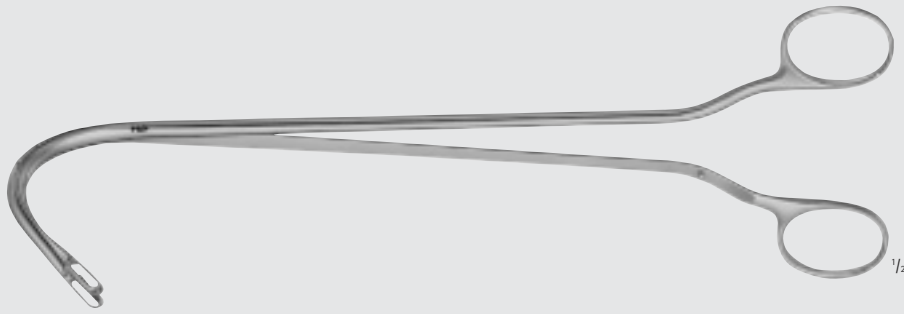
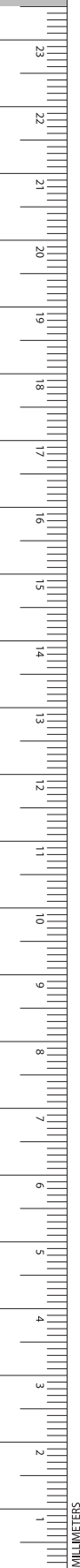

EB246R

RANDALL Kidney Stone Forceps

Catalog Number	Jaw	Length (in.)
EB246R	CVD	9
EF051R	SLT-CVD	9
EF052R	CVD	9
EF053R	HVY-CVD	9
EF054R	U-CVD	9



EF051R - EF054R

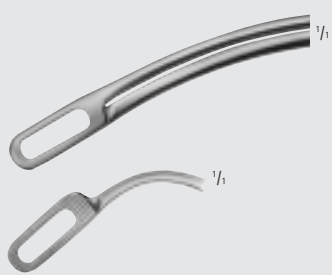

EF051R



EF052R



EF053R



EF054R

RANDALL Kidney Stone Forceps
(continued)

Catalog Number	Jaw	Length (in.)
EF055R	CVD	7 1/2
EF056R	HVY-CVD	7 1/2

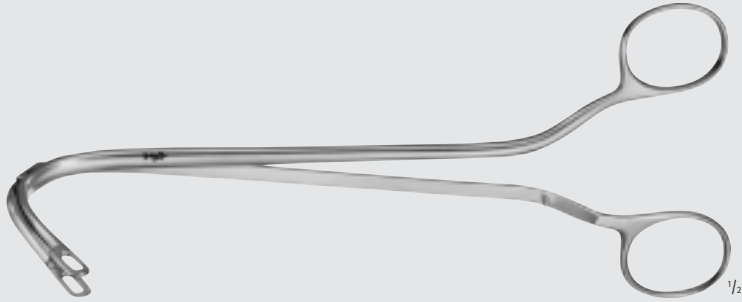

EF055R-EF056R

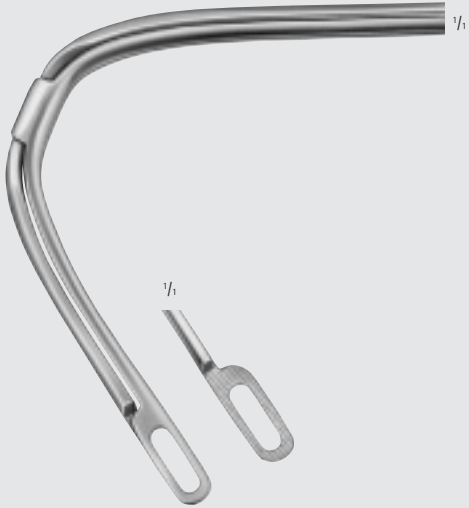

EF055R



EF056R



INCHES

General Surgery

Hemostatic Forceps & Clamps



BH332R-BH339R



BH332R



BH334R



BH336R



BH338R



BH333R



BH335R



BH337R



BH339R

SPENCER-WELLS Forceps

Catalog Number	Jaw	Length (in.)
BH332R	STR	5 1/8
BH333R	CVD	5 1/8
BH334R	STR	6
BH335R	CVD	6
BH336R	STR	7
BH337R	CVD	7
BH338R	STR	8
BH339R	CVD	8

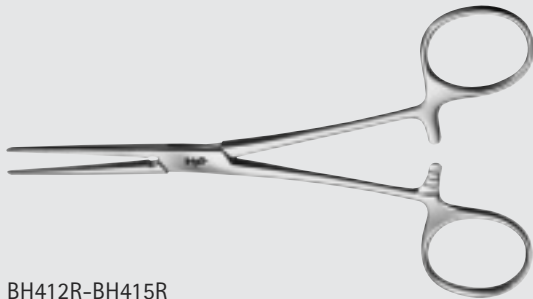

BH412R-BH415R



BH412R



BH413R



BH414R



BH415R

PEAN Forceps, Delicate

Catalog Number	Jaw	Length (in.)
BH412R	STR	5 1/8
BH413R	CVD	5 1/8
BH414R	STR	5 1/2
BH415R	CVD	5 1/2

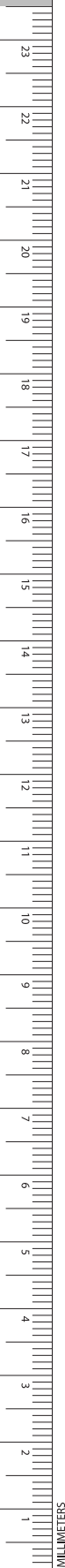

PEAN Forceps

Catalog Number	Jaw	Length (in.)
BH410R	STR	5
BH422R	STR	5 1/8
BH424R	STR	5 1/2
BH425R	CVD	5 1/2

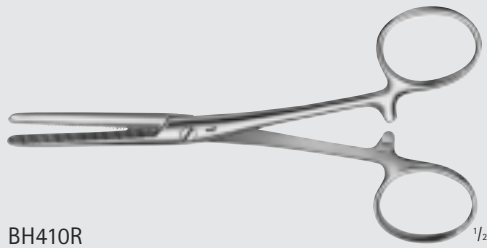

BH410R



BH410R

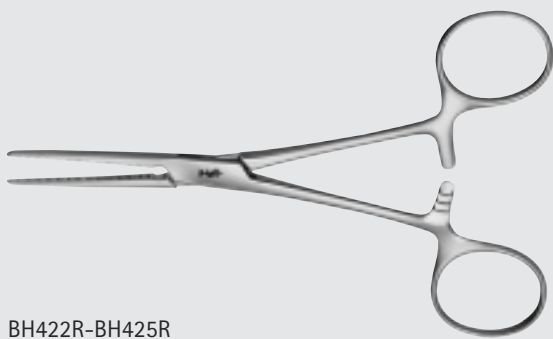

BH422R-BH425R



BH422R



BH424R



BH425R

PEAN Artery Forceps

Catalog Number	Jaw	Length (in.)
MB180R	CVD	12
MB181R	CVD	14



MB180R-MB181R



General Surgery

Hemostatic Forceps & Clamps

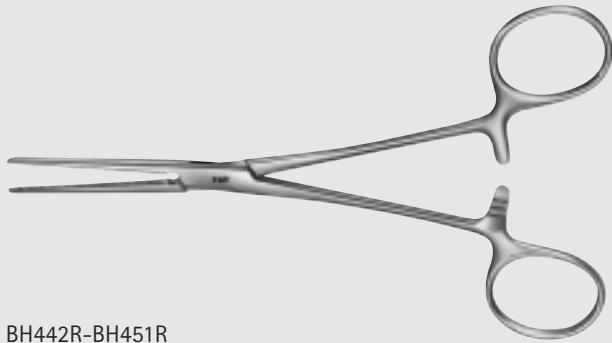

BH442R-BH451R

BH442R



BH444R



BH446R



BH448R



BH450R



ROCHESTER-PEAN Forceps

Catalog Number	Jaw	Length (in.)
BH442R	STR	6 1/4
BH443R	CVD	6 1/4
BH444R	STR	7 1/4
BH445R	CVD	7 1/4
BH446R	STR	8
BH447R	CVD	8
BH448R	STR	9
BH449R	CVD	9
BH450R	STR	9 1/2
BH451R	CVD	9 1/2

BH443R



BH445R



BH447R



BH449R



BH451R

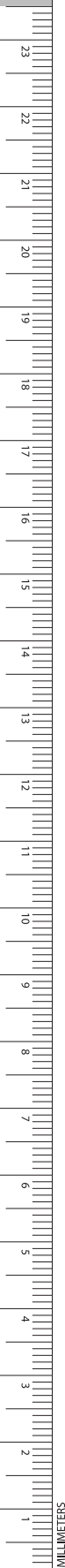

PEAN Forceps, Long

Catalog Number	Jaw	Length (in.)
BH470R	STR	9 1/2
BH471R	CVD	9 1/2
BH472R	STR	10 1/4
BH473R	CVD	10 1/4
BH474R	STR	11
BH475R	CVD	11
MB128R	STR	12

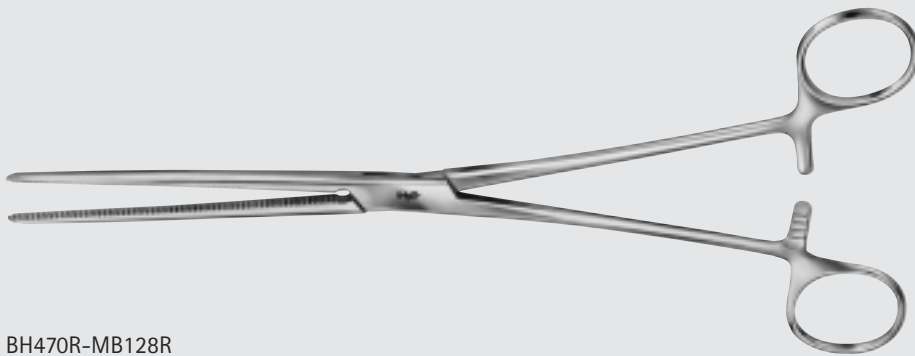

BH470R-MB128R



BH470R



BH472R



BH474R

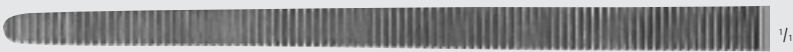

MB128R



BH471R



BH473R

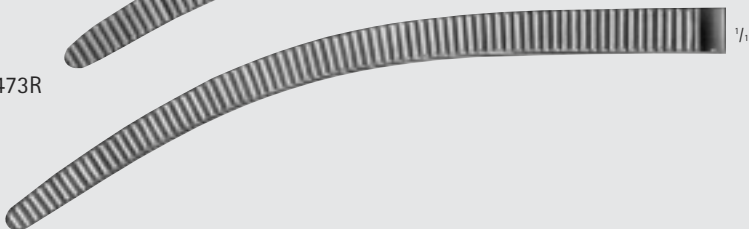

BH475R



INCHES

General Surgery

Hemostatic Forceps & Clamps

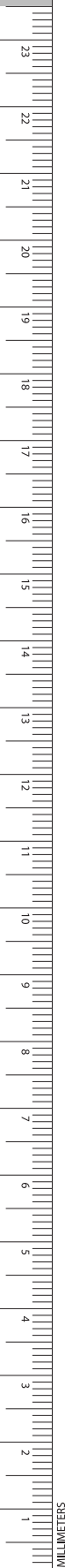

BH614R-BH615R

1/2

BH614R



1/4

KOCHER Delicate Forceps

Catalog Number	Jaw	Teeth	Length (in.)
BH614R	STR	1 x 2	5 1/2
BH615R	CVD	1 x 2	5 1/2



BH615R



BH630R-BH631R

1/2

BH630R



1/4

KOCHER Forceps

Catalog Number	Jaw	Teeth	Length (in.)
BH630R	STR	1 x 2	6
BH631R	CVD	1 x 2	6

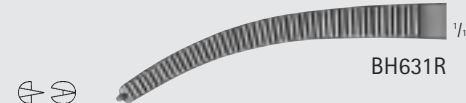

BH631R

ROCHESTER-OCHSNER Forceps

Catalog Number	Jaw	Teeth	Length (in.)
BH618R	STR	1 x 2	5 1/2
BH619R	CVD	1 x 2	5 1/2



BH618R-BH619R



BH618R



BH619R

ROCHESTER-OCHSNER Artery Forceps

Catalog Number	Jaw	Teeth	Length (in.)
MB172R	STR	1 x 2	14

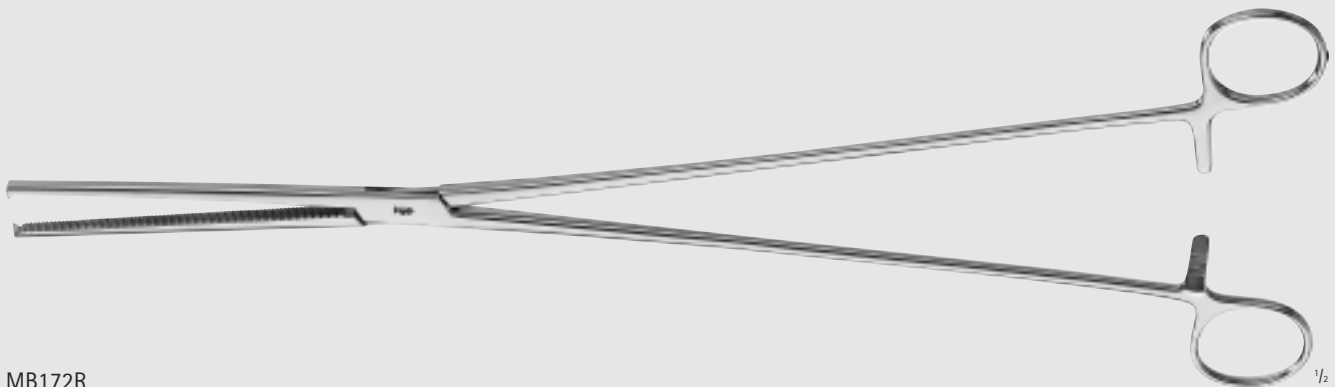

MB172R



1/4



General Surgery

Hemostatic Forceps & Clamps

GENL

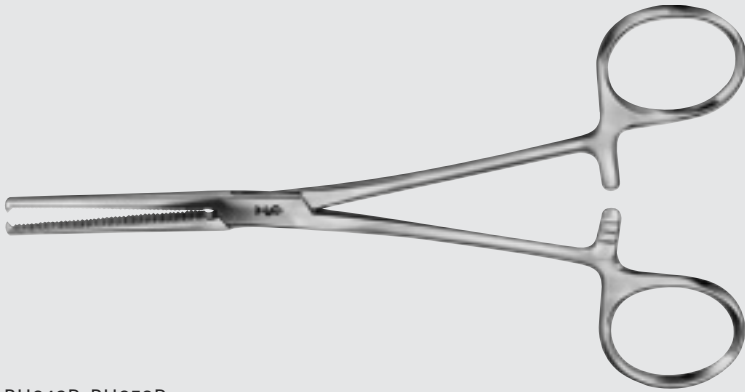
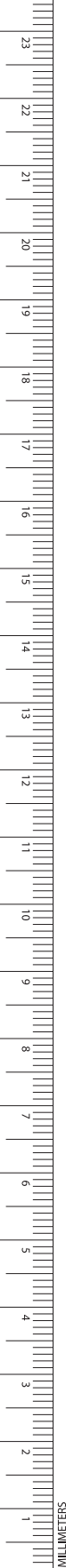

KOCHER-OCHSNER Forceps

Catalog Number	Jaw	Teeth	Length (in.)
BH642R	STR	1 x 2	6 1/4
BH643R	CVD	1 x 2	6 1/4
BH644R	STR	1 x 2	7 1/4
BH645R	CVD	1 x 2	7 1/4
BH646R	STR	1 x 2	8
BH647R	CVD	1 x 2	8
BH648R	STR	1 x 2	9
BH649R	CVD	1 x 2	9
BH650R	STR	1 x 2	9 1/2
BH651R	CVD	1 x 2	9 1/2
BH652R	STR	1 x 2	10 1/4
BH653R	CVD	1 x 2	10 1/4

BH642R-BH653R

BH642R

BH644R

BH646R

BH648R

BH650R

BH652R

BH649R

BH651R

BH653R

BH643R

BH645R

BH647R

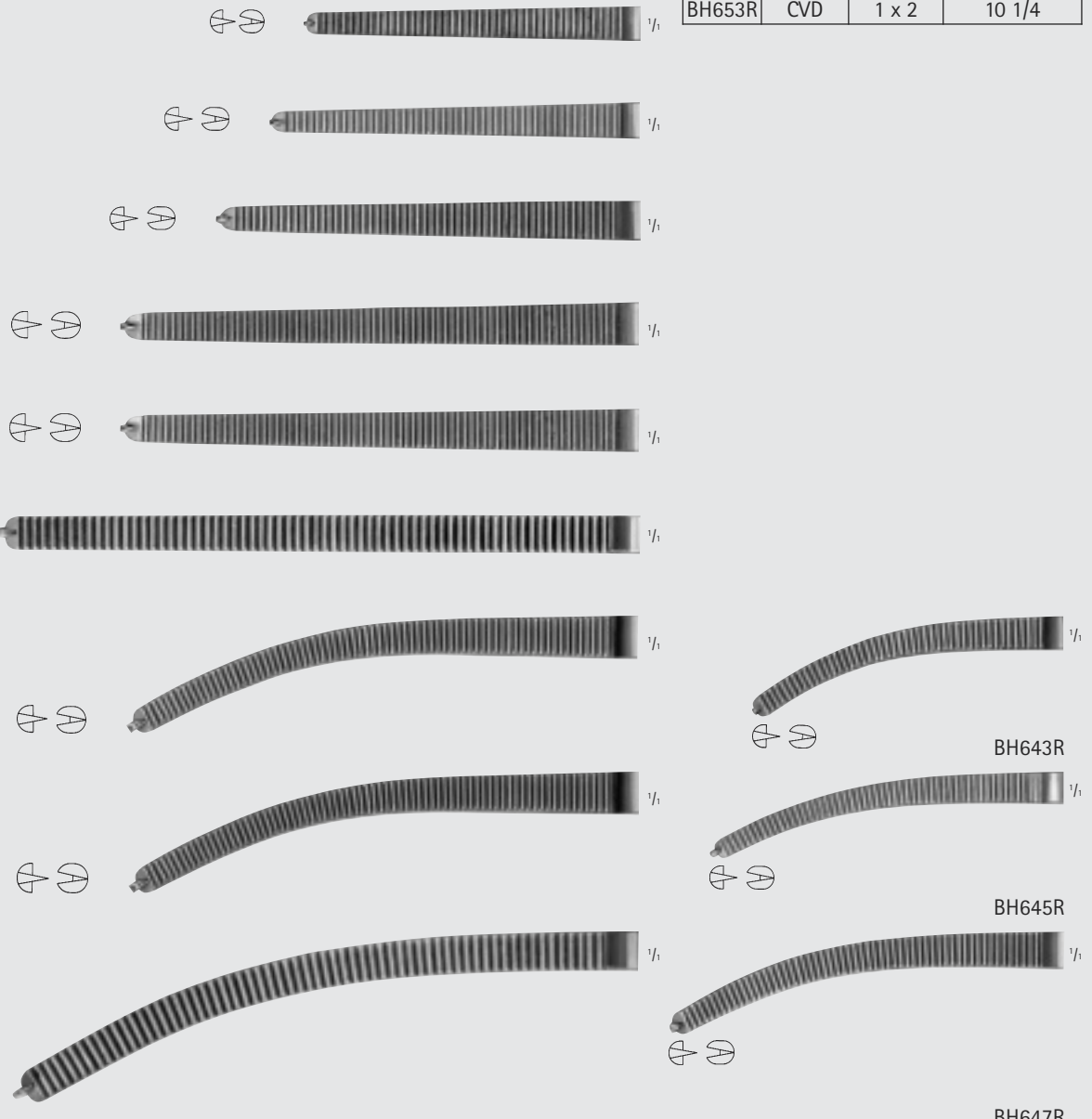

KOCHER-OCHSNER Forceps
(continued)

Catalog Number	Jaw	Teeth	Length (in.)
BH654R	STR	1 x 2	11
BH655R	CVD	1 x 2	11

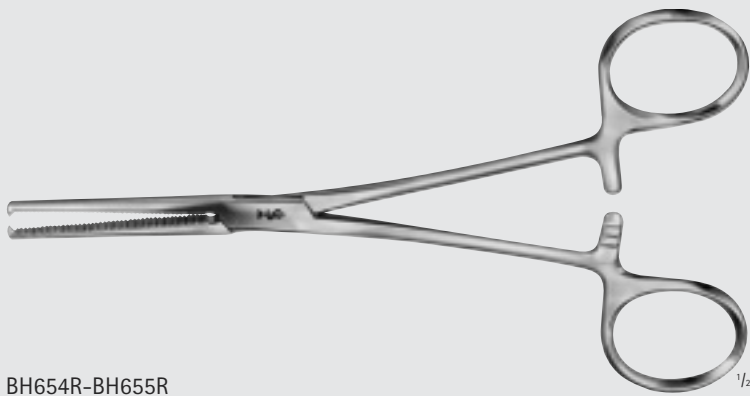

BH654R-BH655R



BH654R

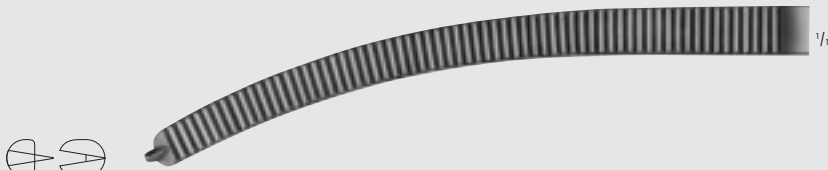

BH655R

ROCHESTER-OCHSNER Forceps

Catalog Number	Jaw	Teeth	Length (in.)
MB807R	STR	1 x 2	14

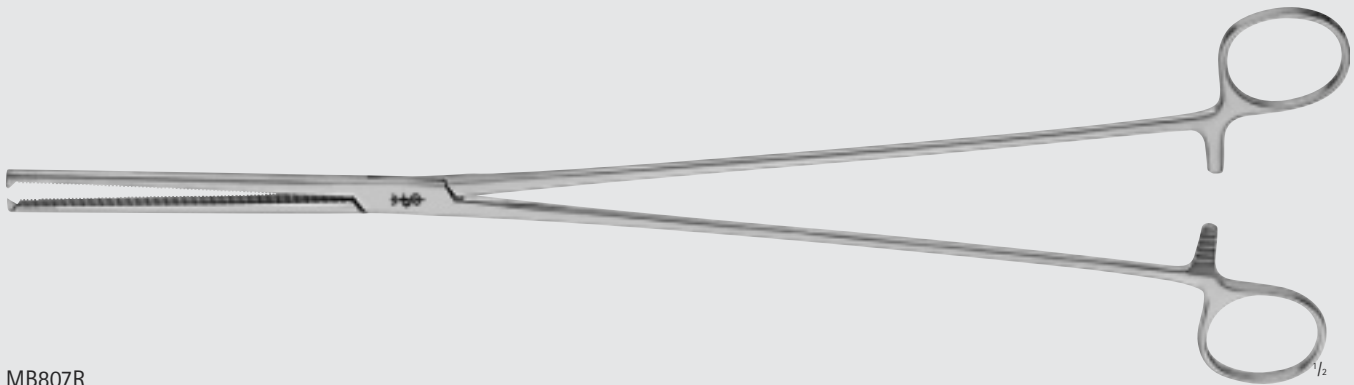

MB807R



INCHES

General Surgery

Hemostatic Forceps & Clamps

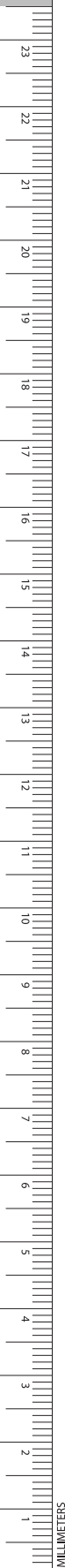
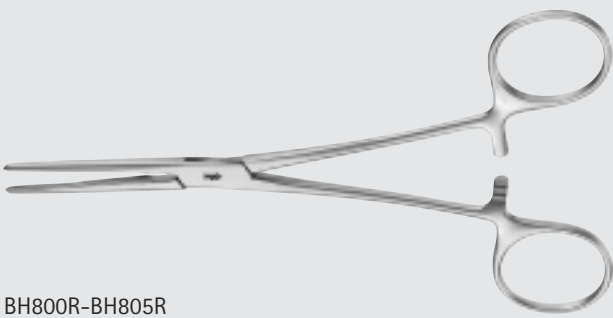
ROCHESTER-CARMALT Forceps

Catalog Number	Jaw	Length (in.)
BH800R	STR	6 1/4
BH801R	CVD	6 1/4
BH804R	STR	8
BH805R	CVD	8

BH800R-BH805R



BH800R 1/4



BH804R 1/4



BH801R 1/4



BH805R 1/4

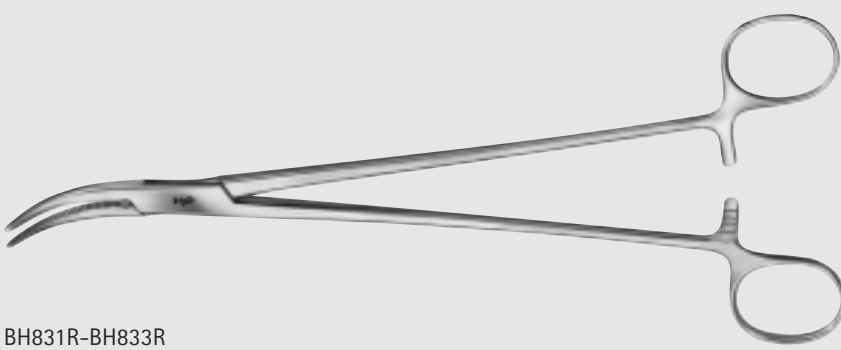

MOYNIHAN Forceps

Catalog Number	Jaw	Length (in.)
BH831R	CVD	9
BH833R	CVD	9 1/2

BH831R-BH833R

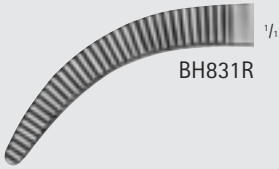

BH831R 1/4

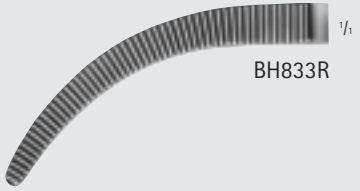

BH833R 1/4

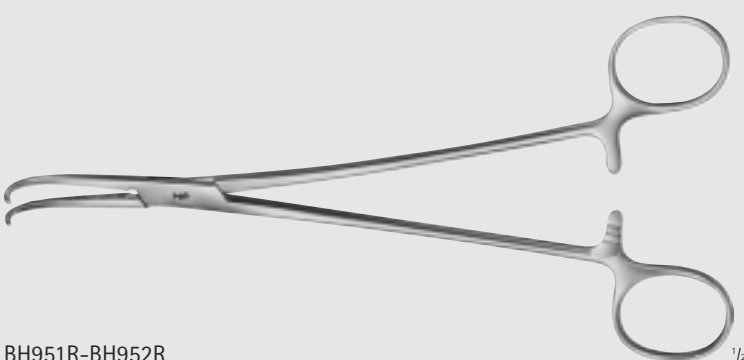

NEGUS Tonsil Forceps

Catalog Number	Jaw	Length (in.)
BH951R	HVY-CVD	7 1/2
BH952R	U-CVD	7 1/2

BH951R-BH952R 1/2

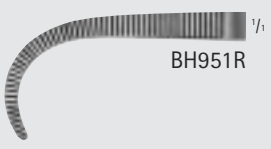

BH951R 1/4



BH952R 1/4

CARMALT Artery Forceps

Catalog Number	Jaw	Length (in.)
MB182R	CVD	12

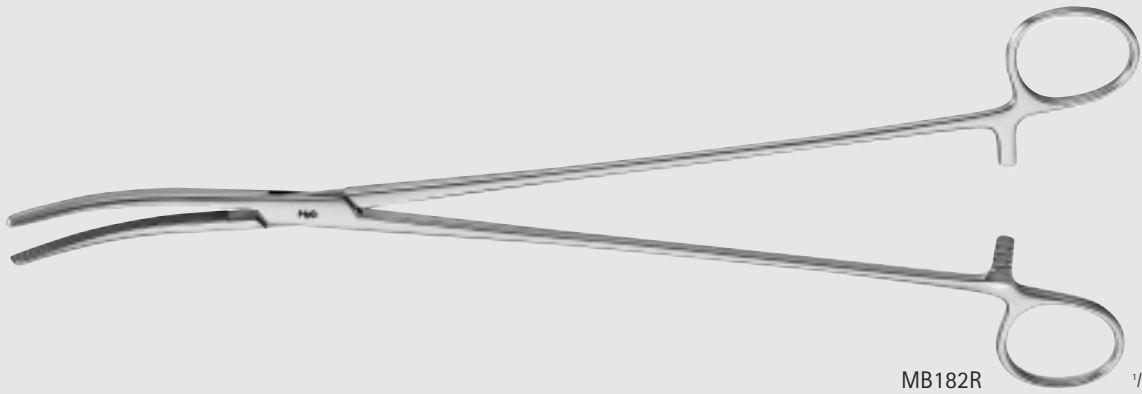

MB182R 1/2

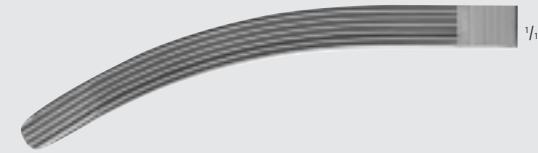

SCHNIDT Tonsil Forceps

Catalog Number	Jaw	Handle	Length (in.)
BH957R	SLT-CVD	CLSD-RING	7 1/4
BH959R	CVD	CLSD-RING	7 1/4
BH961R	SLT-CVD	OPEN-RING	7 1/4
BH963R	CVD	OPEN-RING	7 1/4

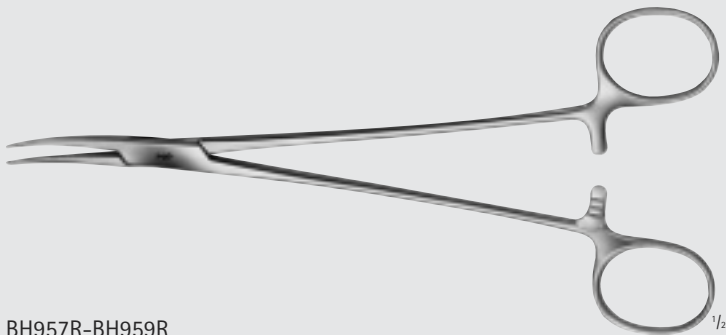

BH957R-BH959R



BH957R



BH959R

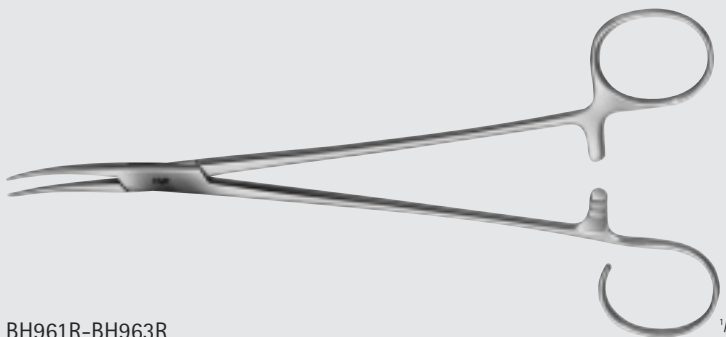

BH961R-BH963R



BH961R



BH963R



INCHES

General Surgery

Hemostatic Forceps & Clamps

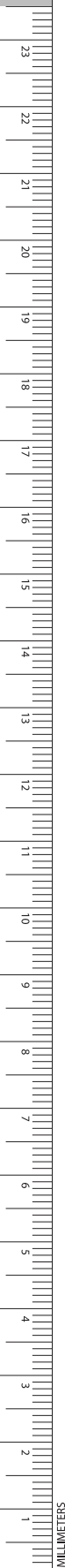

MD450 $\frac{1}{2}$

$\frac{1}{4}$

Catalog Number	Jaw	Teeth	Length (in.)
MD450	STR	1 x 2	6 1/4

OCHSNER-DIXON Artery Forceps

BH104R-BH115R $\frac{1}{2}$

BH104R $\frac{1}{4}$

BH114R $\frac{1}{4}$

BH105R $\frac{1}{4}$

BH115R $\frac{1}{4}$

Catalog Number	Jaw	Teeth	Length (in.)
BH104R	STR	-	4
BH105R	CVD	-	4
BH114R	STR	1 x 2	4
BH115R	CVD	1 x 2	4

BABY-MOSQUITO (HARTMANN) Artery Forceps

BH108R-BH119R $\frac{1}{2}$

BH108R $\frac{1}{4}$

BH118R $\frac{1}{4}$

BH109R $\frac{1}{4}$

BH119R $\frac{1}{4}$

Catalog Number	Jaw	Teeth	Length (in.)
BH108R	STR	-	5
BH109R	CVD	-	5
BH118R	STR	1 x 2	5
BH119R	CVD	1 x 2	5

MICRO-HALSTED Mosquito Forceps, Delicate

HALSTED-MOSQUITO Forceps Delicate

Catalog Number	Jaw	Teeth	Length (in.)
BH110R	STR	-	5
BH111R	CVD	-	5
BH120R	STR	1 x 2	5
BH121R	CVD	1 x 2	5



BH110R-BH121R



BH110R

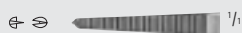

BH120R



BH111R



BH121R

JACOBSON Mosquito Forceps

Catalog Number	Jaw	Length (in.)
BH106R	STR	5
MB229R	CVD	5

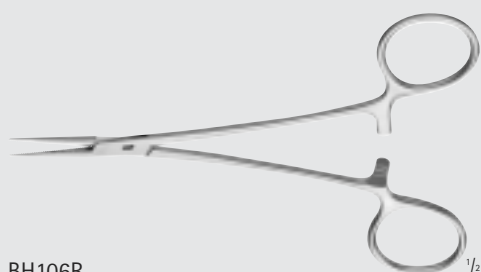

BH106R



1/4

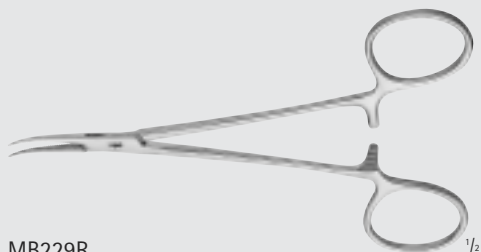

MB229R



1/4

General Surgery

Hemostatic Forceps & Clamps

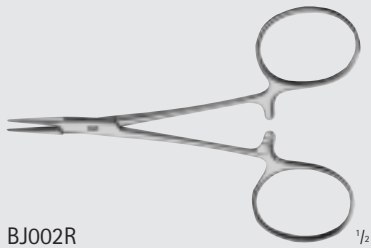

BJ002R



Suture Forceps

Catalog Number	Tip	Jaw	Length (in.)
BJ002R	SMOOTH	STR	3 3/4

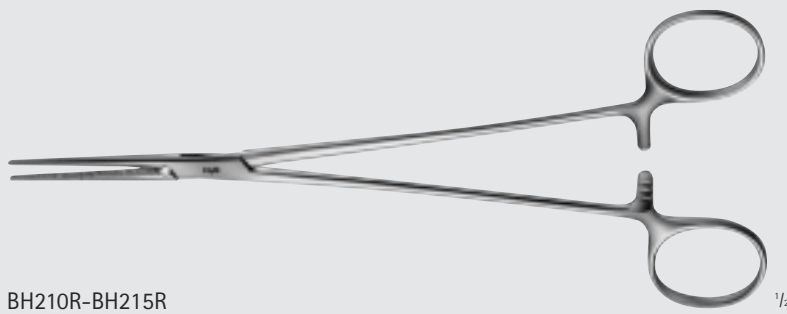

BH210R-BH215R

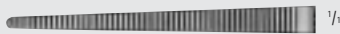

BH210R



BH214R



BH211R



BH215R

HALSTED-MOSQUITO Forceps, Delicate

Catalog Number	Jaw	Teeth	Length (in.)
BH210R	STR	-	8
BH211R	CVD	-	8
BH214R	STR	1 x 2	8
BH215R	CVD	1 x 2	8

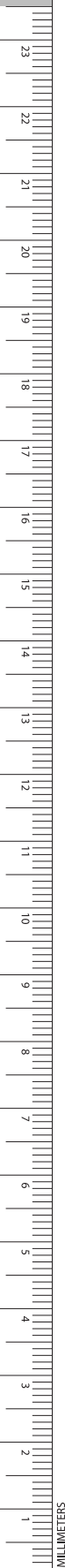

JACOBSON Hemostatic Forceps

Catalog Number	Jaw	Length (in.)
BH187R	SLT-CVD	7 1/2
BH189R	HVY-CVD	7 1/2

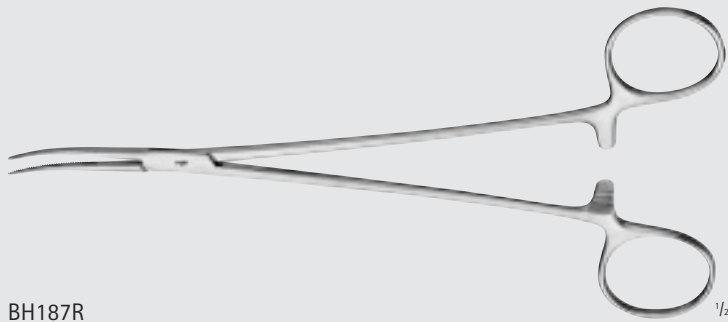

BH187R

1/2



1/1

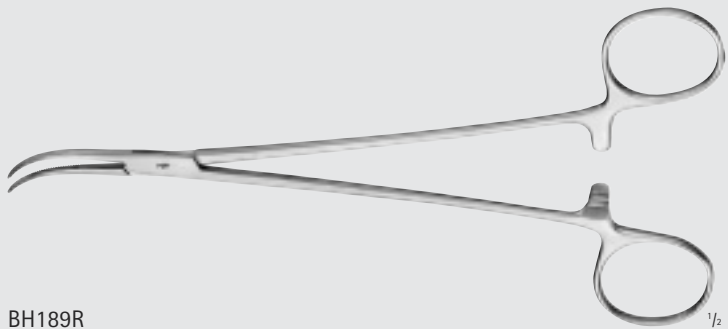

BH189R

1/2



1/1



INCHES

General Surgery

Hemostatic Forceps & Clamps

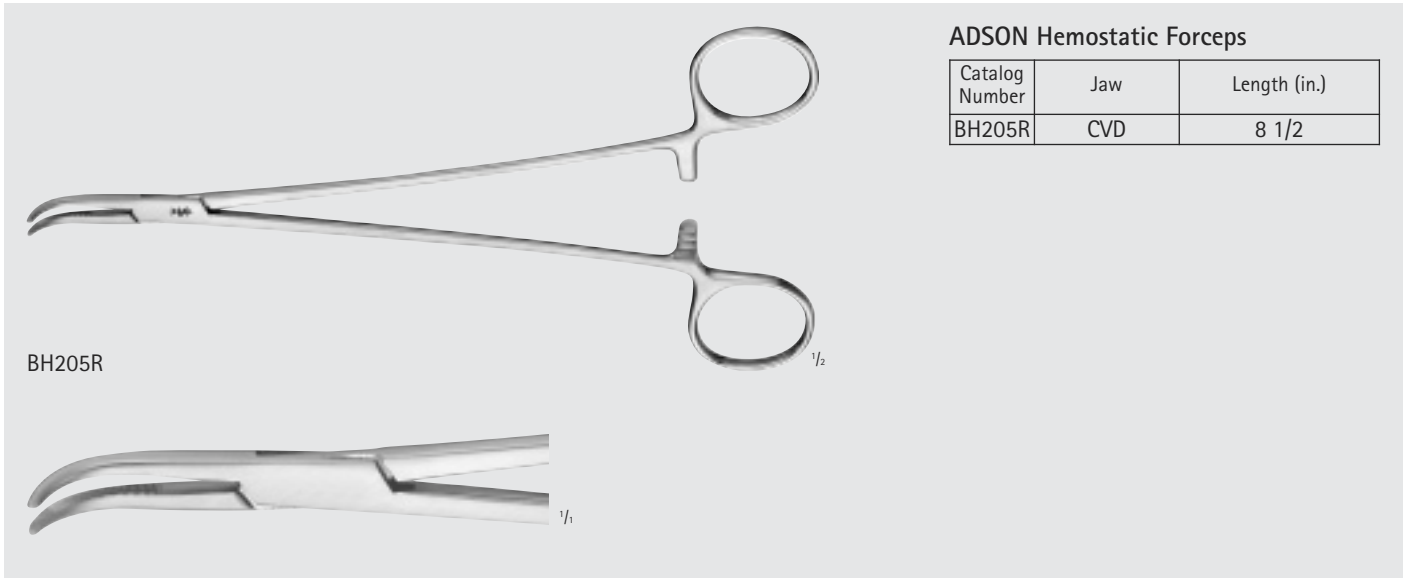
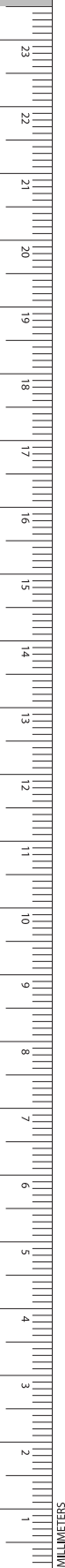

ADSON Hemostatic Forceps

Catalog Number	Jaw	Length (in.)
BH205R	CVD	8 1/2

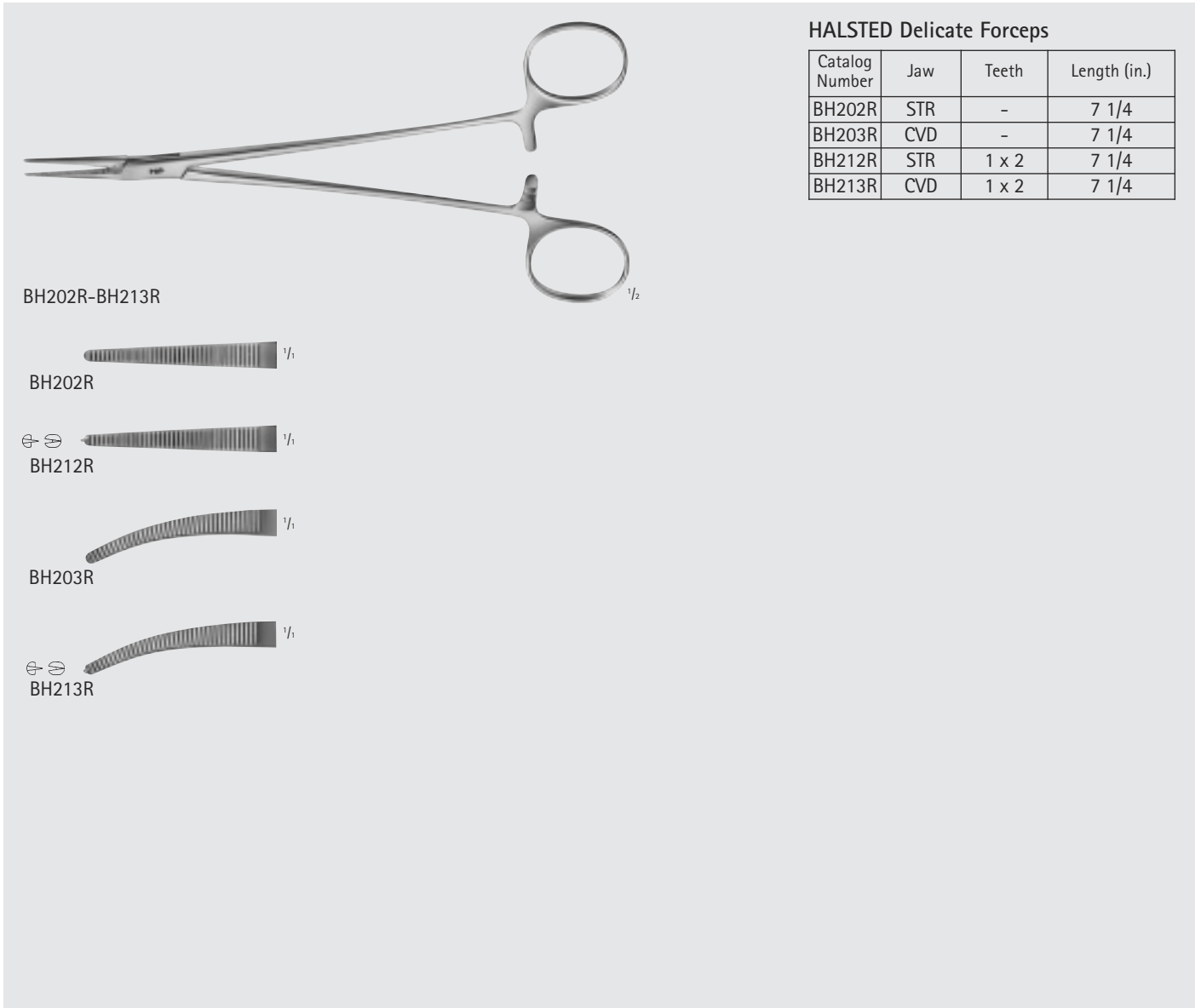

HALSTED Delicate Forceps

Catalog Number	Jaw	Teeth	Length (in.)
BH202R	STR	-	7 1/4
BH203R	CVD	-	7 1/4
BH212R	STR	1 x 2	7 1/4
BH213R	CVD	1 x 2	7 1/4



PROVIDENCE-HOSPITAL Forceps, Delicate

Catalog Number	Jaw	Length (in.)
BH130R	STR	5 1/2
BH131R	CVD	5 1/2

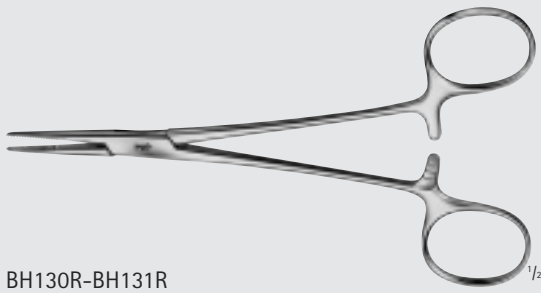

BH130R-BH131R

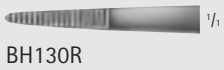

BH130R



BH131R

KELLY Forceps

Catalog Number	Jaw	Length (in.)
BH134R	STR	5 1/2
BH135R	CVD	5 1/2

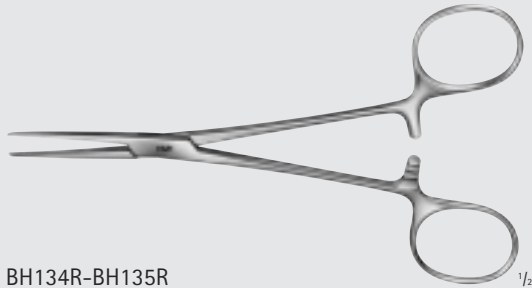

BH134R-BH135R



BH134R



BH135R

BABY-CRILE Forceps

Catalog Number	Jaw	Length (in.)
BH140R	STR	5 1/2
BH141R	CVD	5 1/2



BH140R-BH141R



BH140R



BH141R

General Surgery

Hemostatic Forceps & Clamps

GENL

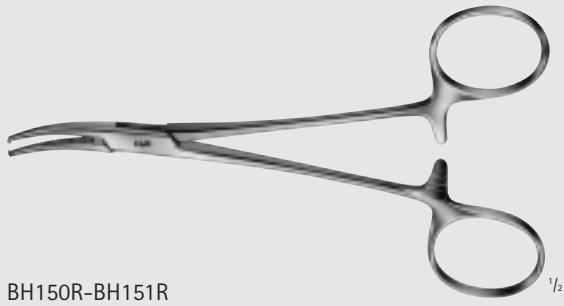
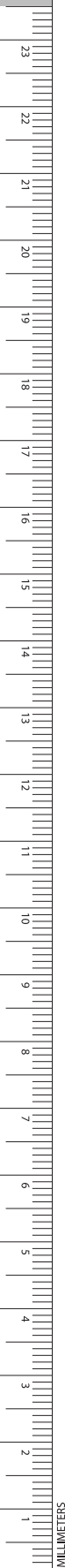

BH150R-BH151R



BH150R



BH151R

BABY-CRILE Forceps

Catalog Number	Jaw	Teeth	Length (in.)
BH150R	STR	1 x 2	5 1/2
BH151R	CVD	1 x 2	5 1/2



BH144R-BH155R



BH144R



BH154R

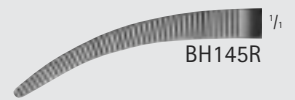

BH145R



BH155R

CRILE Forceps

Catalog Number	Jaw	Teeth	Length (in.)
BH144R	STR	-	5 1/2
BH145R	CVD	-	5 1/2
BH154R	STR	1 x 2	5 1/2
BH155R	CVD	1 x 2	5 1/2
BH166R	STR	-	6 1/4
BH167R	CVD	-	6 1/4
BH176R	STR	1 x 2	6 1/4
BH177R	CVD	1 x 2	6 1/4

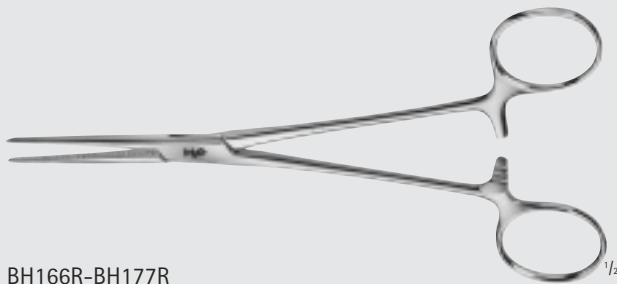

BH166R-BH177R

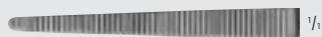

BH166R



BH176R



BH167R



BH177R

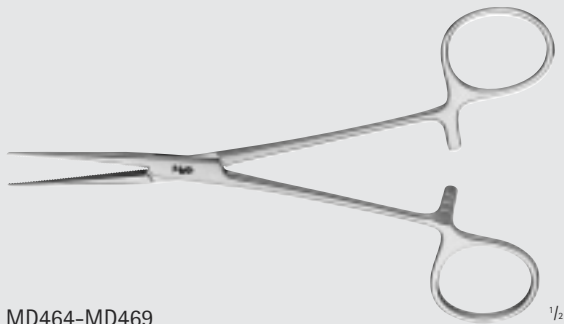

MD464-MD469

1/2

COLLER Artery Forceps

Catalog Number	Jaw	Length (in.)
MD464	STR	5 3/4
MD465R	CVD	5 3/4
MD466R	STR	6 1/2
MD467R	CVD	6 1/2
MD468	STR	7
MD469	CVD	7

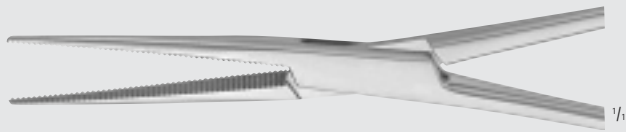

MD464

1/4



MD466R

1/4

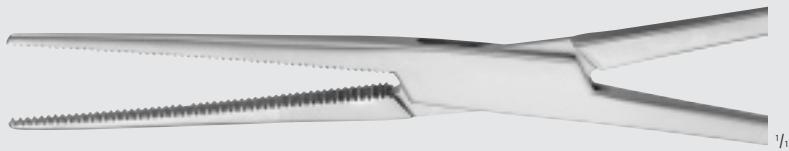

MD468

1/4

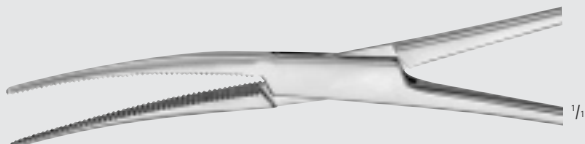

MD465R

1/4

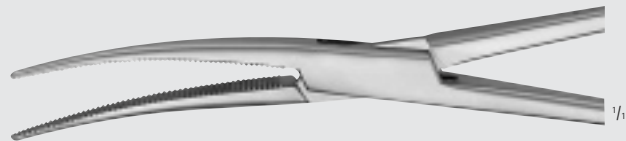

MD467R

1/4



MD469

1/4



INCHES

General Surgery

Hemostatic Forceps & Clamps



BH160R-BH171R



BH160R



BH170R



BH161R



BH171R

LERICHE Delicate Forceps

Catalog Number	Jaw	Teeth	Length (in.)
BH160R	STR	-	6
BH161R	CVD	-	6
BH170R	STR	1 x 2	6
BH171R	CVD	1 x 2	6



BH164R-BH165R



BH164R



BH165R

RANKIN Forceps Delicate

Catalog Number	Jaw	Length (in.)
BH164R	STR	6 1/4
BH165R	CVD	6 1/4

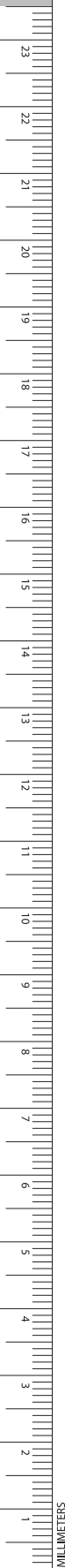



BIRKETT Hemostatic Forceps

Catalog Number	Jaw	Length (in.)
BH197R	CVD	7 1/4

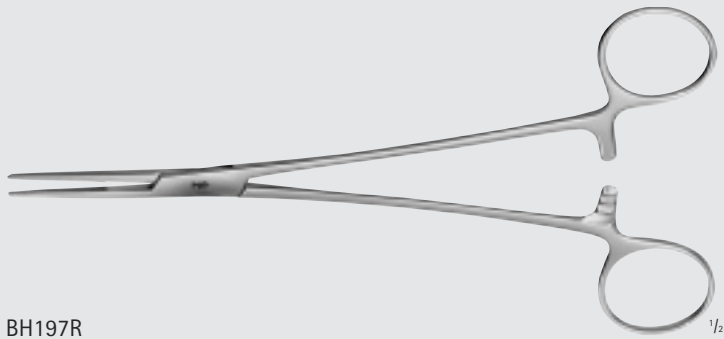

BH197R

1/2



1/4

NISSEN Delicate Tonsil Forceps

Catalog Number	Jaw	Length (in.)
BH199R	CVD	7 1/4

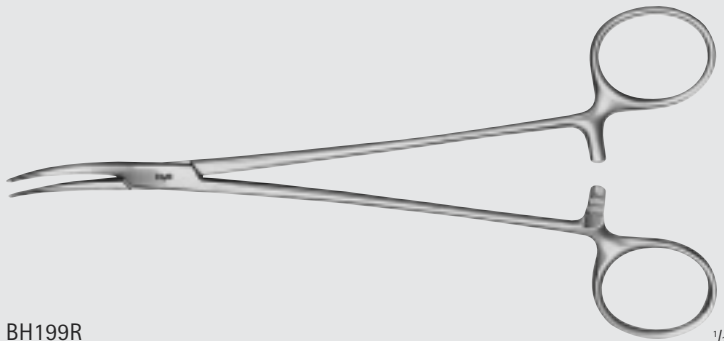

BH199R

1/2



1/4

ADSON Delicate Tonsil Forceps

Catalog Number	Jaw	Length (in.)
BH200R	STR	7 1/4
BH201R	CVD	7 1/4

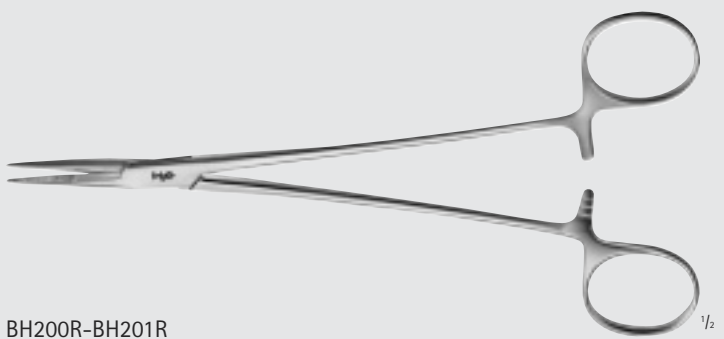

BH200R-BH201R

1/2



1/4

BH200R



1/4

BH201R

General Surgery

Hemostatic Forceps & Clamps

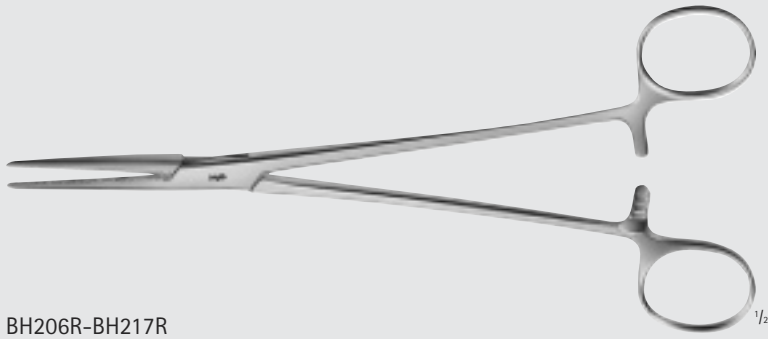

BH206R-BH217R



BH206R



BH216R

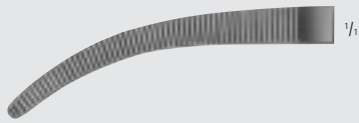

BH207R



BH209R



BH217R

HEISS Delicate Forceps

Catalog Number	Jaw	Teeth	Length (in.)
BH206R	STR	-	8
BH207R	CVD	-	8
BH209R	HVY-CVD	-	8
BH216R	STR	1 x 2	8
BH217R	CVD	1 x 2	8

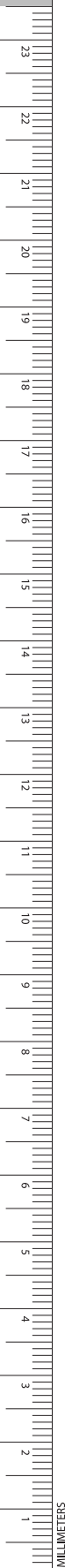

BENGOLEA Delicate Forceps

Catalog Number	Jaw	Length (in.)
BH228R	STR	9 3/4
BH229R	CVD	9 3/4

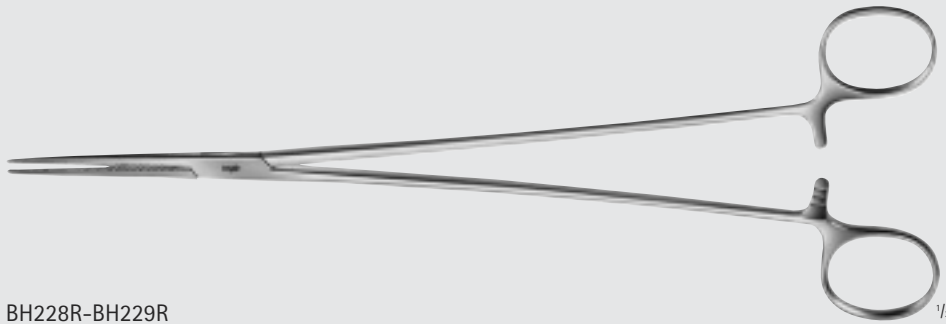

BH228R-BH229R



BH228R



BH229R

BRIDGE Delicate Forceps

Catalog Number	Jaw	Length (in.)
BH230R	STR	10 3/4
BH231R	CVD	10 3/4

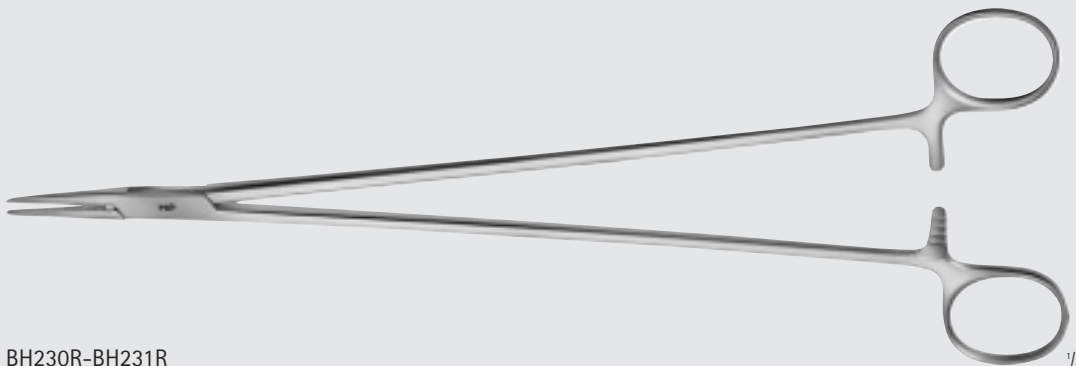

BH230R-BH231R



BH230R

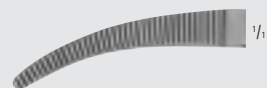

BH231R



INCHES

General Surgery

Dissecting & Right Angle Forceps

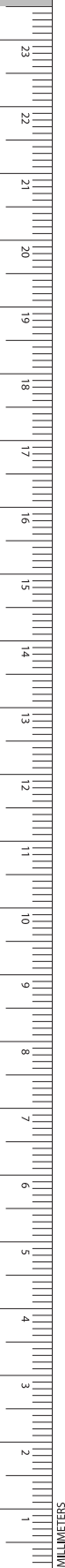

GEMINI Right Angle Forceps

Catalog Number	Length (in.)
BJ100R	5 1/8
BJ102R	7
BJ103R	8
BJ104R	9
BJ106R	11

BJ100R-BJ106R

BJ100R BJ102R BJ103R
BJ104R BJ106R

KANTROWITZ Right Angle Forceps

Catalog Number	Length (in.)
BJ057R	8
BJ058R	9 1/2
BJ059R	10 3/4

BJ057R-BJ059R

BJ057R BJ058R BJ059R

HOLLE Forceps, Delicate

Catalog Number	Length (in.)
BJ037R	5 3/4
BJ038R	7 1/4
BJ039R	9 1/4

BJ037R-BJ039R

BJ037R BJ038R BJ039R

General Surgery

Dissecting & Right Angle Forceps

GENL



MB058R

KANTROWITZ Right Angle Forceps

Catalog Number	Length (in.)
MB058R	6 3/8



MB061R

KANTROWITZ Right Angle Forceps

Catalog Number	Length (in.)
MB061R	12



BJ013R-BJ014R

BABY-ADSON Forceps

Catalog Number	Length (in.)
BJ013R	5 1/2
BJ014R	7



BJ008R

MICRO-ADSON Suture Forceps

Catalog Number	Length (in.)
BJ008R	5 1/2



General Surgery

Dissecting & Right Angle Forceps

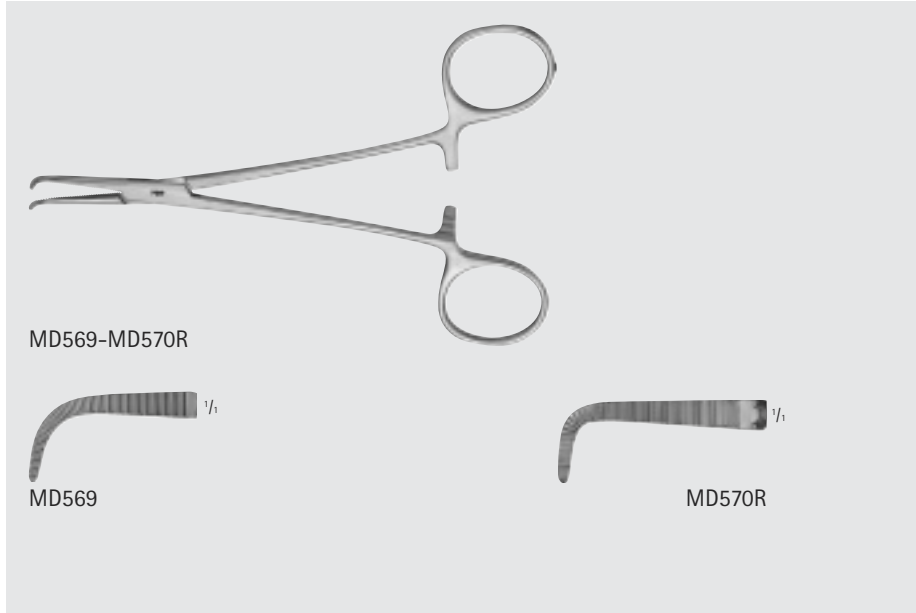

Right Angle Forceps

Catalog Number	Length (in.)
MD569	5 1/2
MD570R	7

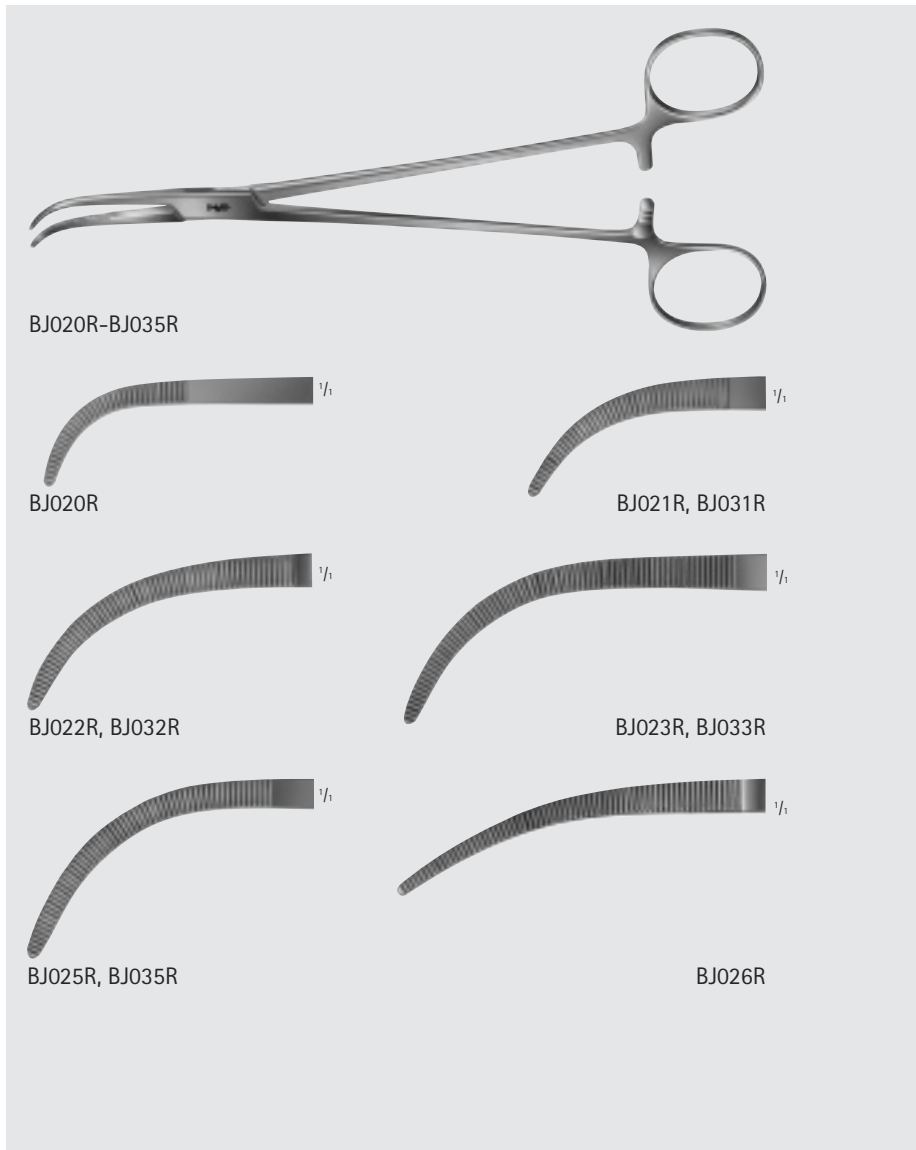

OVERHOLT-GEISSENDOERFER Forceps

Catalog Number	Length (in.)
BJ020R	7 3/4
BJ021R	8 1/4
BJ022R	8 3/4
BJ023R	9
BJ024R	8 3/4
BJ025R	9
BJ026R	9
BJ031R	10 1/4
BJ032R	10 3/4
BJ033R	10 3/4
BJ034R	10 3/4
BJ035R	11

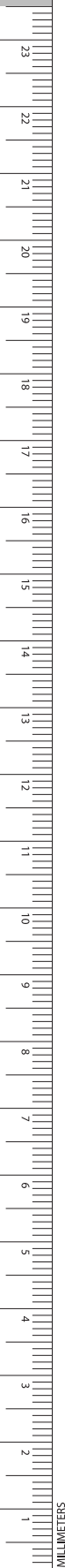

OVERHOLT Forceps

Catalog Number	Length (in.)
BJ080R	8 1/2
BJ081R	8 1/4
BJ082R	8 3/4
BJ083R	9
BJ086R	9
BJ090R	11 3/4
BJ091R	11 3/4
BJ096R	12

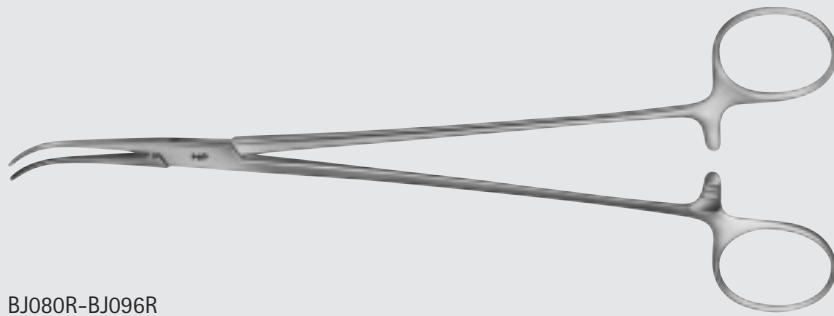

BJ080R-BJ096R

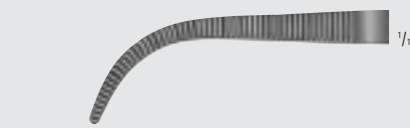

BJ080R



BJ081R

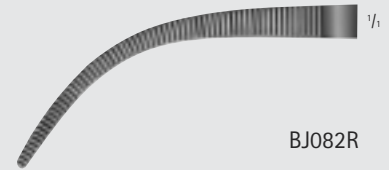

BJ082R

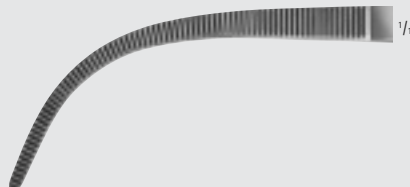

BJ083R

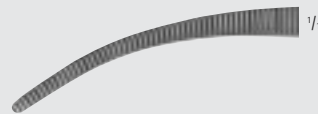

BJ086R

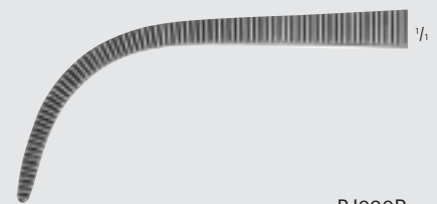

BJ090R

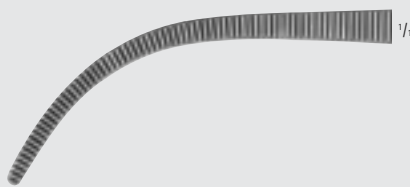

BJ091R



BJ096R

MEEKER Forceps

Catalog Number	Length (in.)
MB459R	11

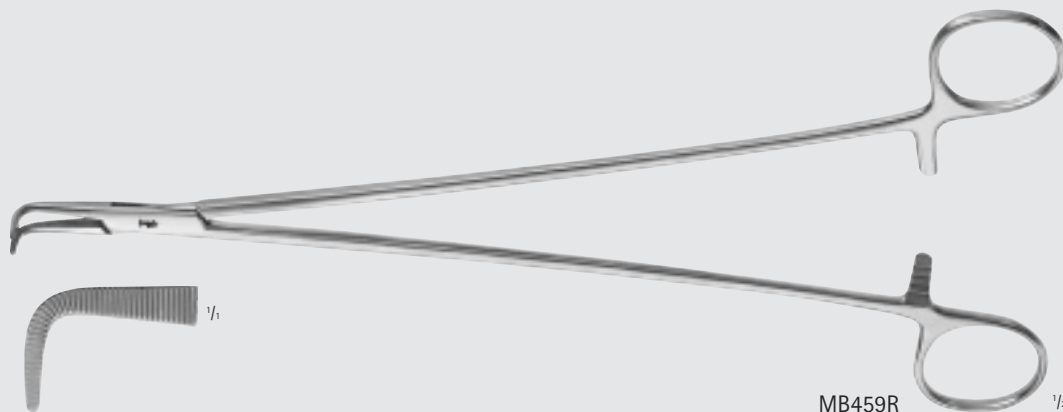

MB459R



INCHES

General Surgery

Dissecting & Right Angle Forceps

ZENKER Forceps

Catalog Number	Jaw	Length (in.)
BJ047R	SLT-CVD	12
BJ048R	HVY-CVD	11 1/2

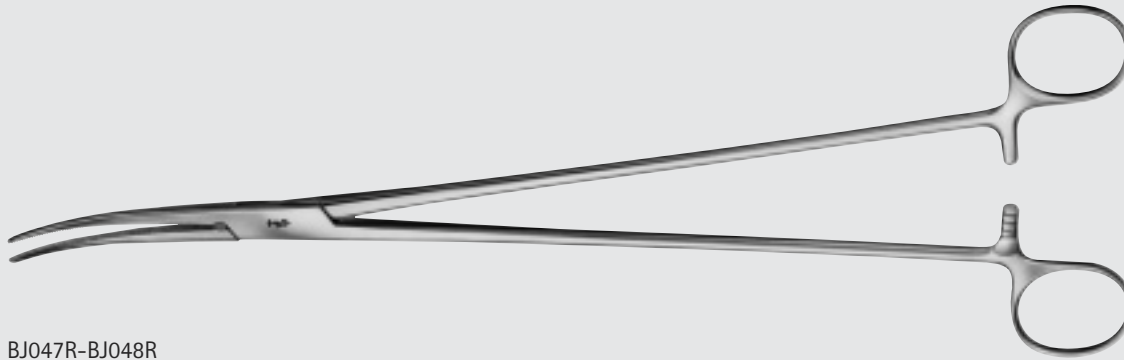

BJ047R-BJ048R

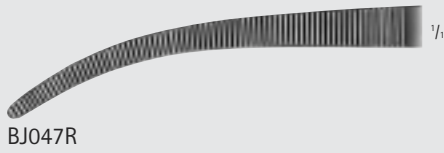

BJ047R

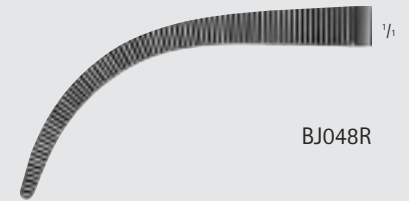

BJ048R

ZENKER Ligature Forceps

Catalog Number	Length (in.)
BJ130R	14
BJ131R	14
BJ132R	14

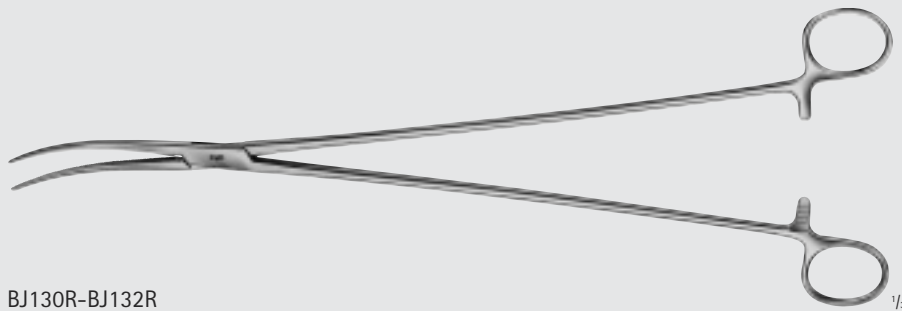

BJ130R-BJ132R



BJ130R

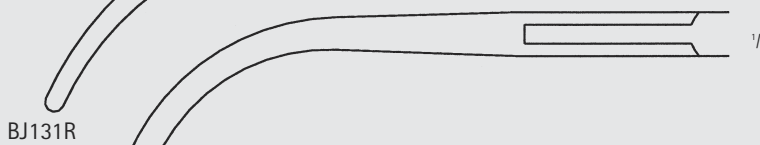

BJ131R

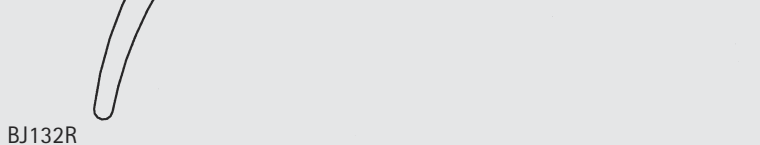

BJ132R



BJ050R 1/2

MIXTER-O'SHAUGNESSY Forceps

Catalog Number	Length (in.)
BJ050R	7 1/2



1/4

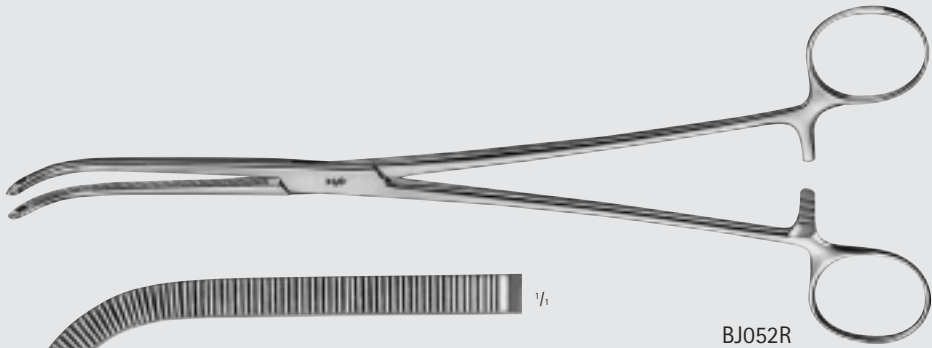

BJ052R 1/2

FINOCHIETTO Forceps

Catalog Number	Length (in.)
BJ052R	9 3/4



1/4

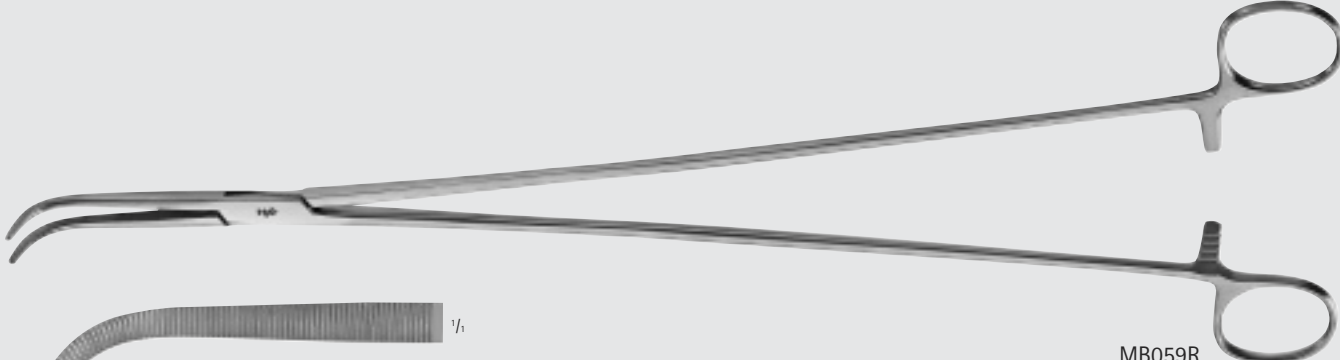

MB059R 1/2

MIXTER Thoracic Forceps

Catalog Number	Length (in.)
MB059R	14



1/4



INCHES

General Surgery

Dissecting & Right Angle Forceps

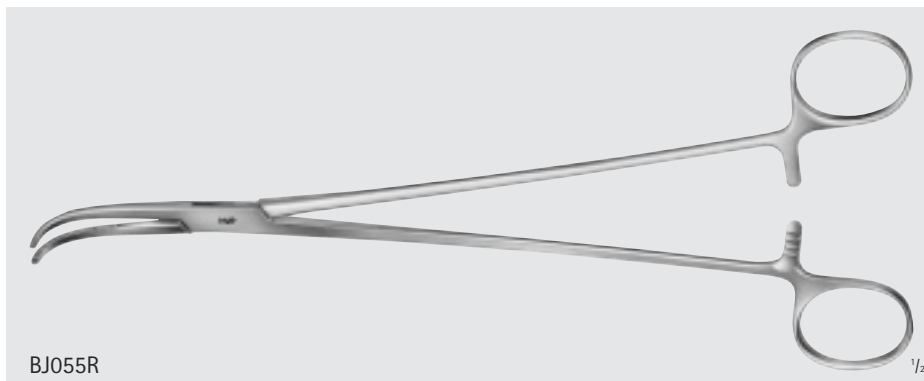

BJO55R

MIXTER Forceps

Catalog Number	Length (in.)
BJ055R	9
BJ061R	8 3/4
BJ062R	10

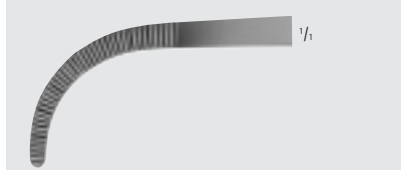

1/2

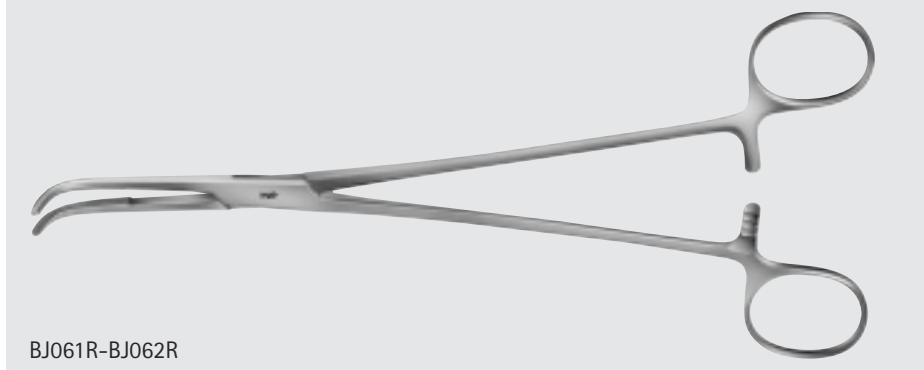

BJO61R-BJO62R



BJO61R



BJO62R

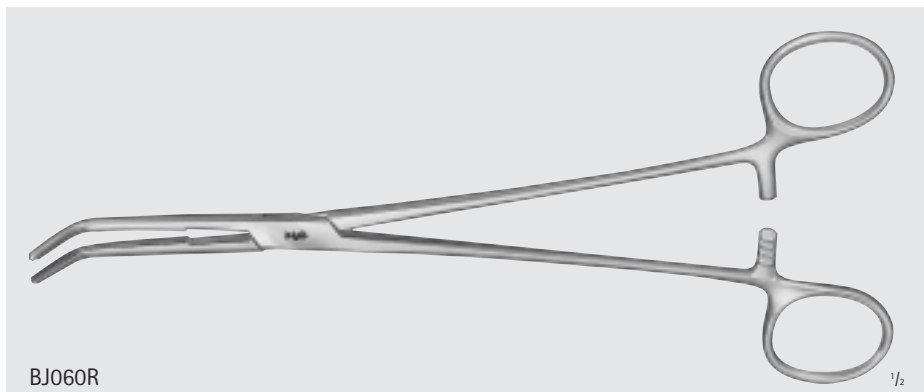

BJO60R

LAHEY Forceps

Catalog Number	Length (in.)
BJ060R	9



1/2

BABY-MIXTER Forceps

Catalog Number	Length (in.)
BJ011R	5 1/2
BJ012R	7

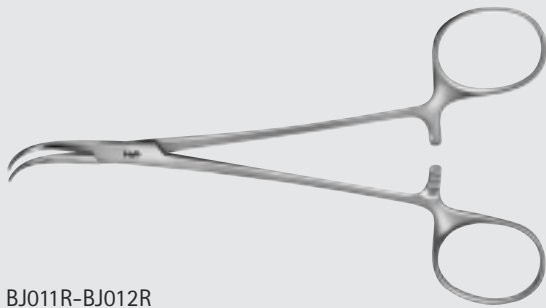

BJ011R-BJ012R



BJ011R



BJ012R

MIXTER Forceps

Catalog Number	Length (in.)
BJ073R	11 1/2
MB808R	14

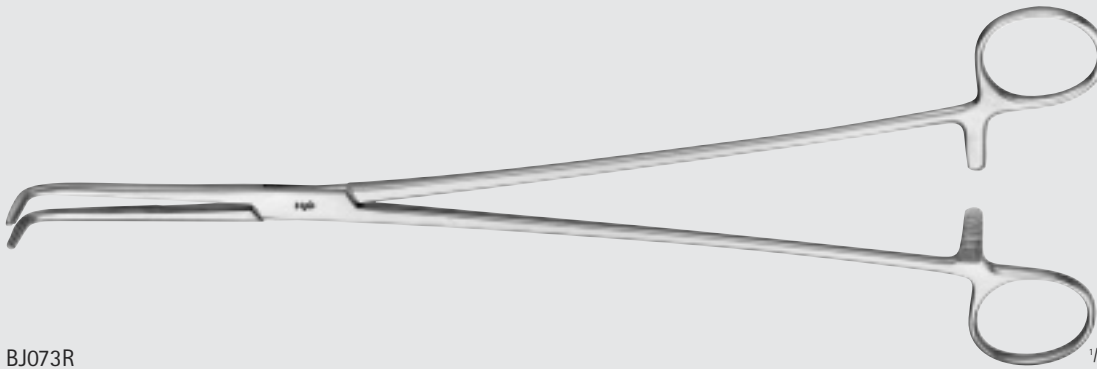

BJ073R

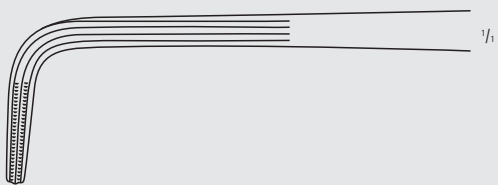

1/2

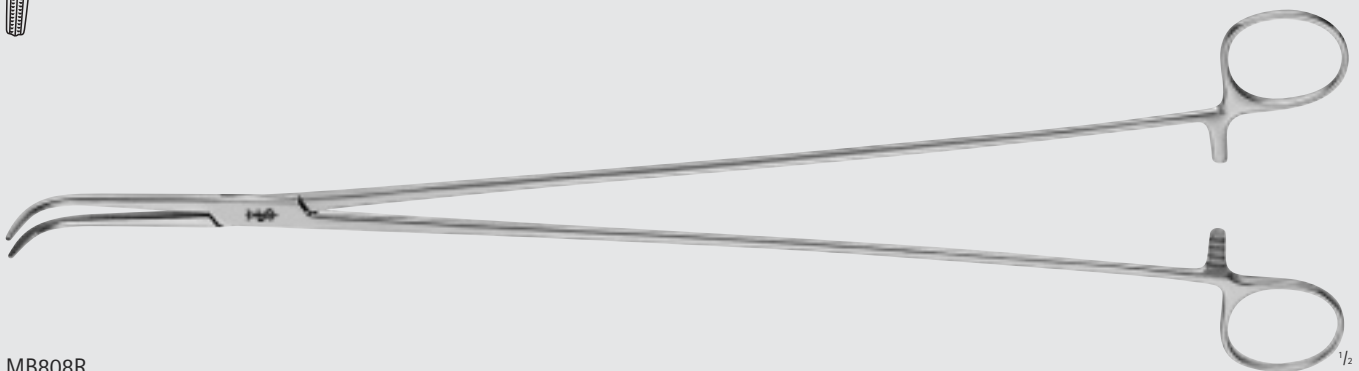

MB808R



1/2



INCHES

General Surgery

Dissecting & Right Angle Forceps

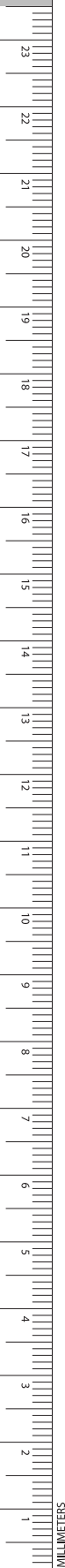

HARRINGTON-MIXTER Forceps

Catalog Number	Length (in.)
BJ072R	12 1/2

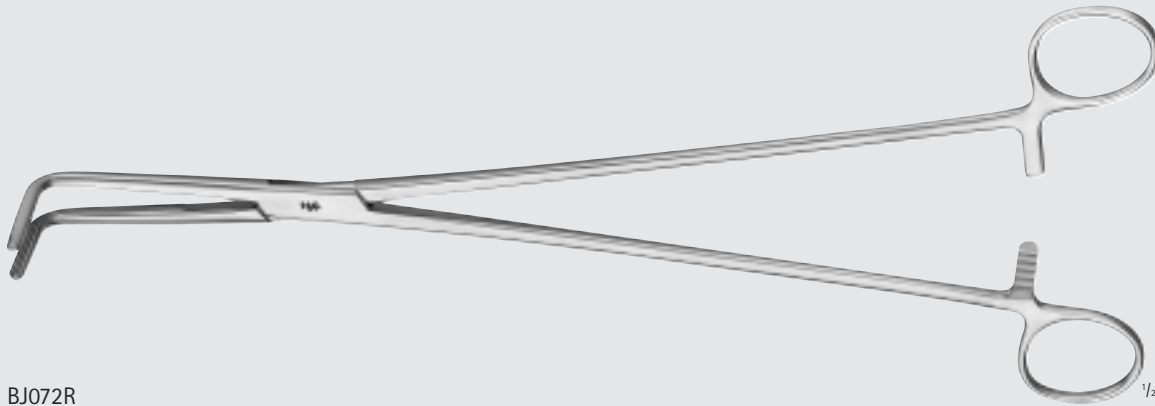

BJ072R

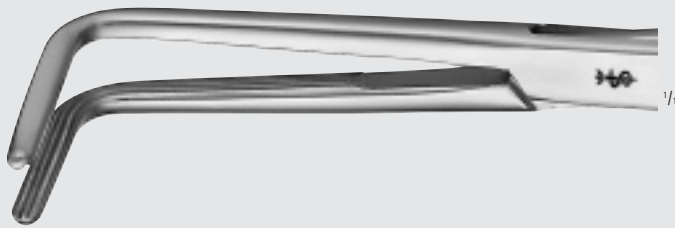

WIKSTROEM Forceps

Catalog Number	Length (in.)
BJ051R	8

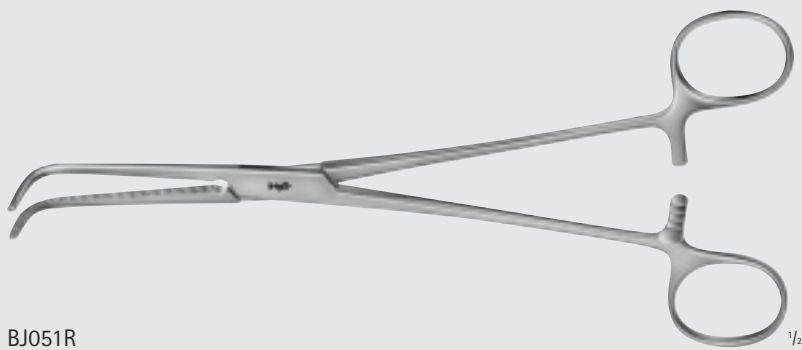

BJ051R



LAWRENCE Forceps

Catalog Number	Length (in.)
BJ070R	10 3/4

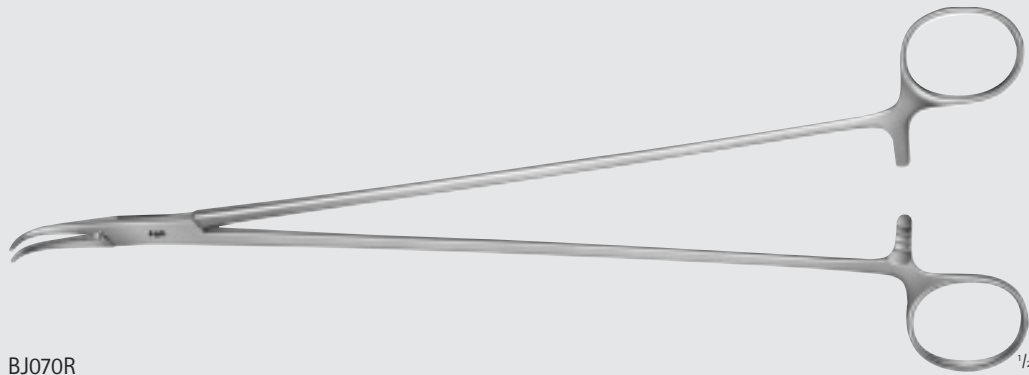

BJ070R



KIEBACK Forceps

Catalog Number	Jaw	Length (in.)
BJ075R	UP-CVD	9 1/4

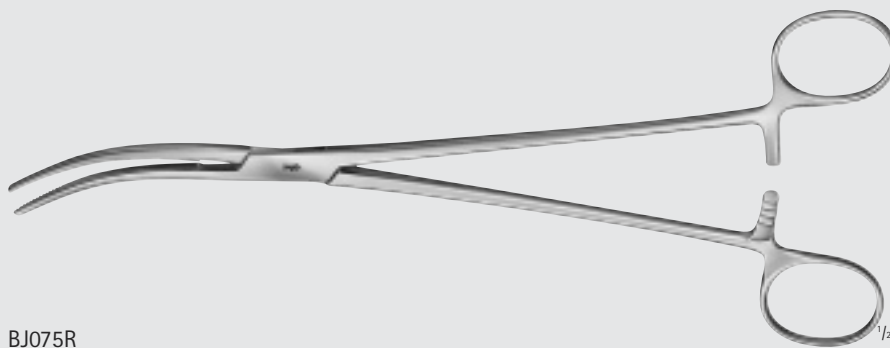

BJ075R



General Surgery

Towel & Tubing Clamps

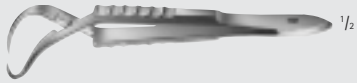

BF407R

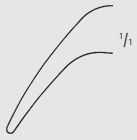

JONES Towel Clamp

Catalog Number	Length (in.)
BF407R	3 3/8

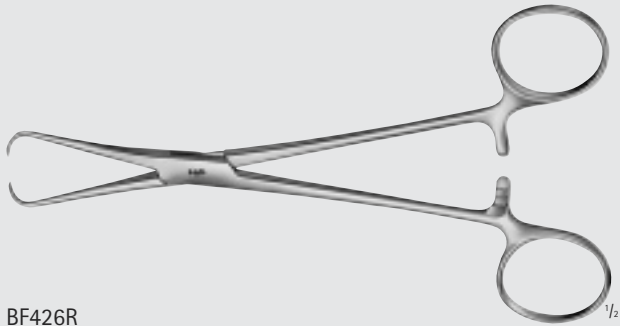

BF426R

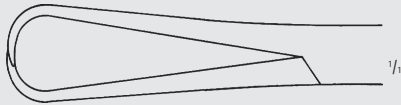

BERNHARD Towel Clamp

Catalog Number	Jaw	Length (in.)
BF426R	STR	6 1/4



BF431R-BF433R



BF431R



BF432R

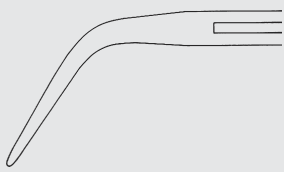

BF433R

BACKHAUS Towel Clamp

Catalog Number	Length (in.)
BF431R	3 1/2
BF432R	4 3/8
BF433R	5 1/4

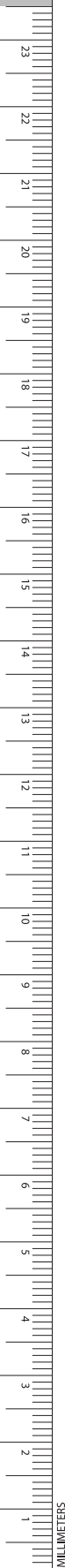

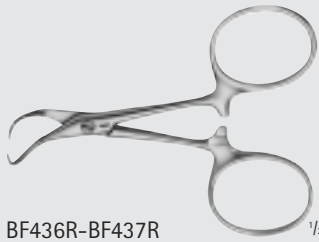

BF436R-BF437R $\frac{1}{2}$

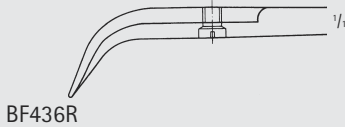

BF436R

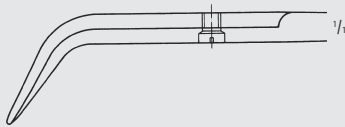

BF437R

BACKHAUS Towel Clamp, W/Screw

Catalog Number	Length (in.)
BF436R	3 1/8
BF437R	4 1/8



BF444R $\frac{1}{2}$

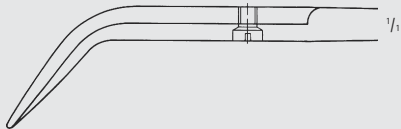

BACKHAUS-KOCHER Towel Clamp, W/Screw

Catalog Number	Length (in.)
BF444R	5 1/4

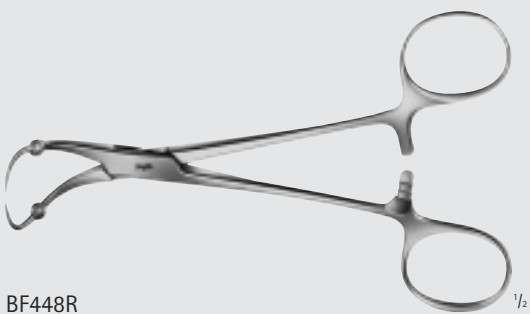

BF448R $\frac{1}{2}$

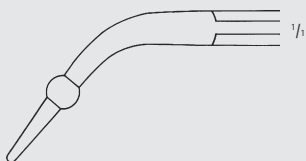

ROEDER Towel Clamp, W/Ball On Jaws

Catalog Number	Length (in.)
BF448R	5 1/4



INCHES

General Surgery

Towel & Tubing Clamps

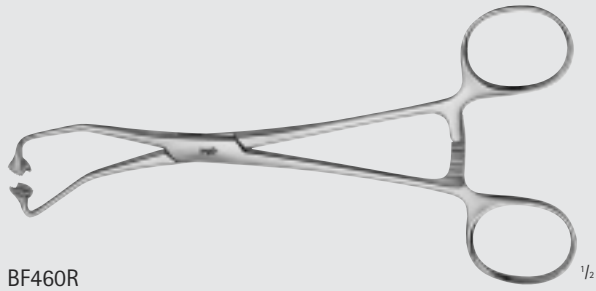
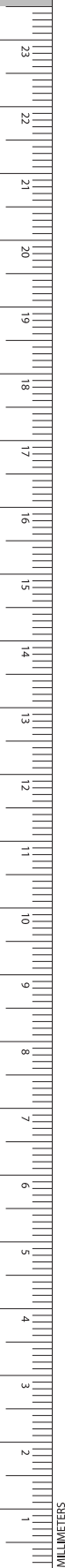

BF460R

1/2

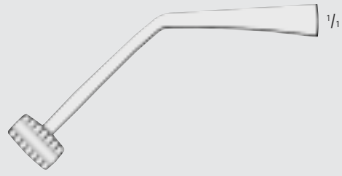

1/4



BF464R

1/2



1/4

Towel Clamp, Paper Drape

Catalog Number	Length (in.)
BF460R	6
BF464R	5 1/2



BF458R-BF459R

1/2



BF458R

1/4

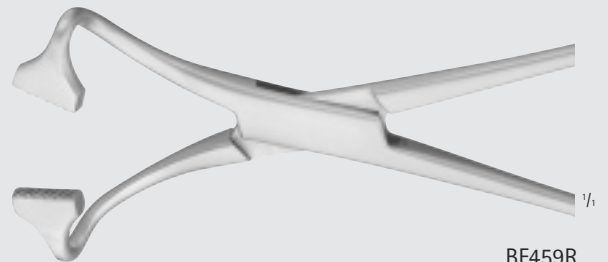

BF459R

Non-Perforating Towel Forceps

Catalog Number	Tip	Length (in.)
BF458R	NON-PERF	4
BF459R	NON-PERF	5 1/4

LORNA Towel Clamp

Catalog Number	Tip	Length (in.)
BF461R	NON-PERF	3 3/4
BF463R	NON-PERF	5 1/8

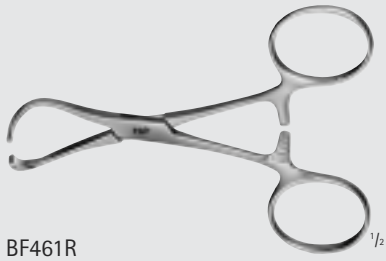

BF461R

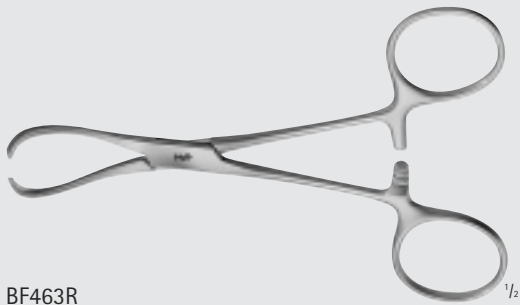

BF463R



Tubing Clamp W/Guard

Catalog Number	Jaw	Length (in.)
MD652	SERR	6
MD653	SERR	7
MD654	SERR	8

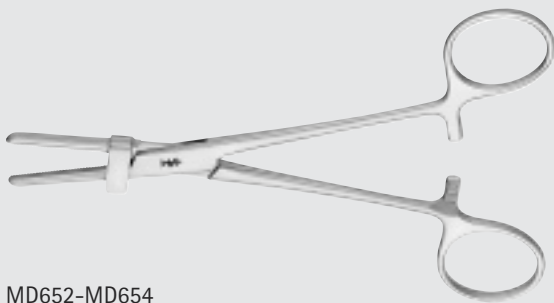

MD652-MD654



MD652



MD653



MD654



INCHES

General Surgery

Skin Hooks



Dimensions for blade size of retractors
 1st number = depth Example: 25 x 38 mm
 2nd number = width

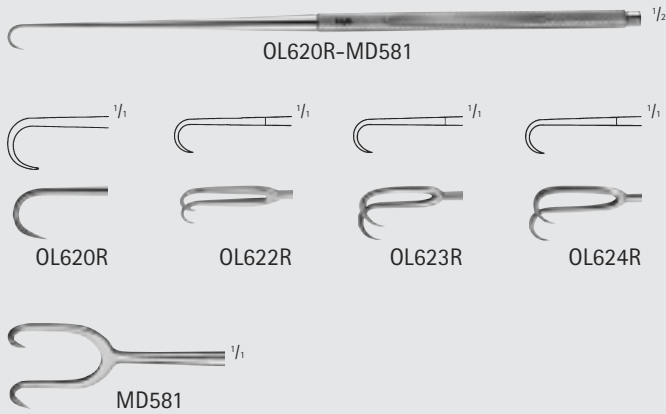

JOSEPH Skin Hook

Catalog Number	Tip	Blade End	Tip Size (mm)	Length (in.)
OL620R	SHARP	1 PRONG	-	6 1/2
OL622R	SHARP	2 PRONGS	3	6 1/2
OL623R	SHARP	2 PRONGS	6	6 1/2
OL624R	SHARP	2 PRONGS	8	6 1/2
MD581	SHARP	2 PRONGS	10	6 1/2



FREER Double Hook

Catalog Number	Tip	Tip Size (mm)	Length (in.)
OL621R	SHARP	2.0 x 3.2	6

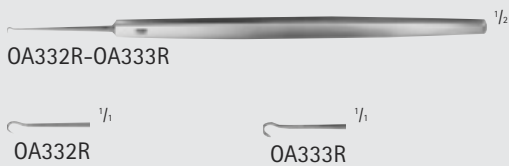

GRAEFE Hook, Fine

Catalog Number	Tip	Length (in.)
OA332R	SHARP	5
OA333R	BLUNT	5

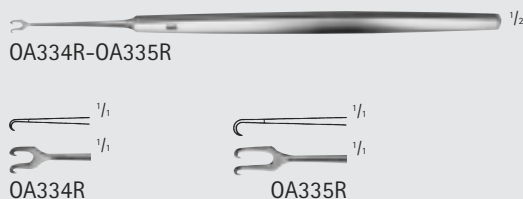

GUTHRIE Double Hook

Catalog Number	Tip	Length (in.)
OA334R	SHARP	5
OA335R	SHARP	5 1/8

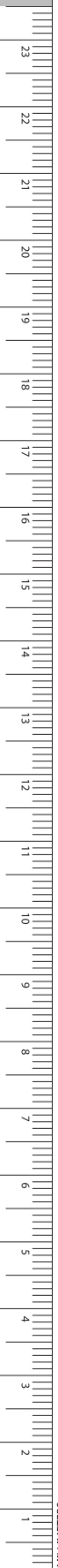



OA336R-OA338R

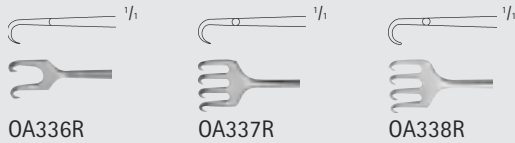

ROLLET Hook Retractor

Catalog Number	Tip	Blade End	Length (in.)
OA336R	SHARP	2 PRONGS	5 1/8
OA337R	SHARP	4 PRONGS	5 1/4
OA338R	BLUNT	4 PRONGS	5 1/4



OA340R

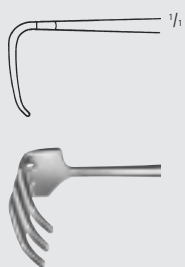

PAUL Tendon Hook

Catalog Number	Tip	Blade End	Blade Size (mm)	Length (in.)
OA340R	BLUNT	3 PRONGS	11 x 8	4 3/4

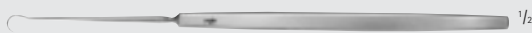

OA351R



JAEGER Hook Retractor, Fine

Catalog Number	Tip	Length (in.)
OA351R	SHARP	5 1/4



OL610R



KILNER Skin Hook

Catalog Number	Tip	Length (in.)
OL610R	SHARP	6 1/4



OL611R-OL612R

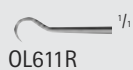

OL611R



OL612R

GILLIES Skin Hook

Catalog Number	Tip	Hook End	Length (in.)
OL611R	SHARP	SMALL	7
OL612R	SHARP	LARGE	7

General Surgery

Skin Hooks

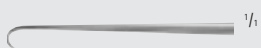

COTTLE Hook

Catalog Number	Tip	Hook End	Length (in.)
OL617R	SHARP	ANG	6 1/4
OL619R	SHARP	HVY-CVD	6 1/4

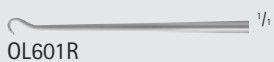

KLEINERT-KUTZ Skin Hook

Catalog Number	Tip Size (mm)	Size	Length (in.)
OL601R	2.5	1	6 1/4
OL602R	4.2	2	6 1/4
OL603R	4.8	3	6 1/4



Prong Micro Hooks

Catalog Number	Tip Size (mm)	Tip	Length (in.)
MB885R	1	SHARP	5 5/8
MB886R	2	SHARP	5 5/8
MB887R	2	BLUNT	5 5/8
MB888R	2	SHARP	5 5/8
MB889R	5	SHARP	5 5/8
MB890R	7	SHARP	5 5/8
MB891R	10	SHARP	5 5/8

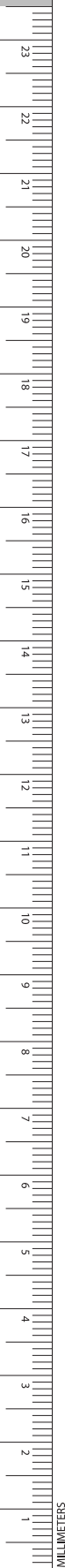



BROM Vein Hook

Catalog Number	Length (in.)
BT075R	6 3/4

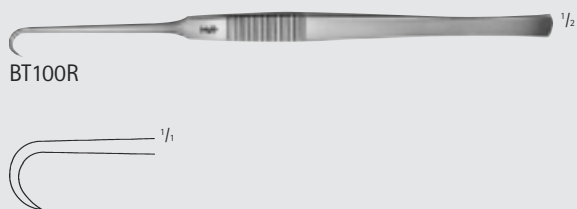

BERGMANN Hook

Catalog Number	Tip	Tip Size (mm)	Length (in.)
BT100R	SHARP	7	5 1/2



EMMET Fistula Hook

Catalog Number	Tip	Length (in.)
BT161R	SHARP	8 3/4

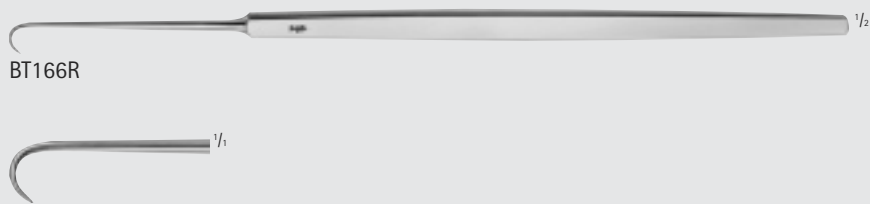

SIMON Fistula Hook

Catalog Number	Tip	Blade End	Length (in.)
BT166R	SHARP	1 PRONG	8 3/4
BT167R	SHARP	2 PRONGS	8 3/4

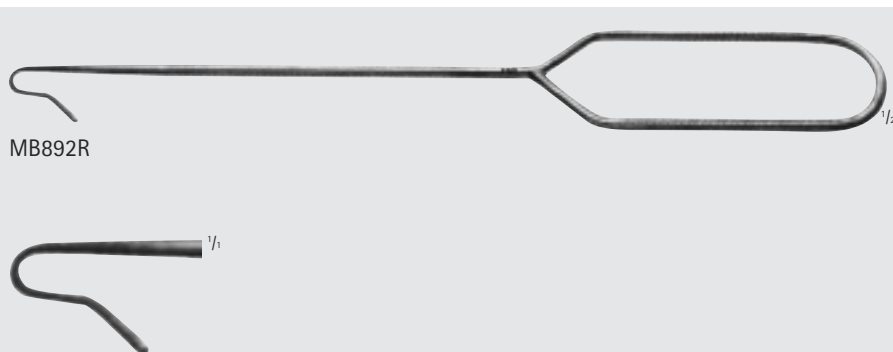

STEWART Crypt Hook

Catalog Number	Length (in.)
MB892R	9

General Surgery

Hand Held Retractors



BT006R-BT007R

BABY-SENN-MILLER Retractor

Catalog Number	Tip	Blade End	Blade Size (mm)	Length (in.)
BT006R	SHARP	3 PRONGS	8 x 7 22 x 7	6
BT007R	BLUNT	3 PRONGS	8 x 7 22 x 7	6

BT006R 8 x 7 mm

BT007R 8 x 7 mm

22 x 7 mm

BT008R

SENN-MILLER Retractor

Catalog Number	Tip	Blade End	Blade Size (mm)	Length (in.)
BT008R	SHARP	3 PRONGS	8 x 7 18 x 5.5	6 1/2

8 x 7 mm

18 x 5.5 mm

BT004R

RAGNELL Retractor

Catalog Number	Blade Size (mm)	Length (in.)
BT004R	3 x 5.0 / 6.3 x 14	6

BT187R

Double Ended Retractor

Catalog Number	Blade Size (mm)	Length (in.)
BT187R	20 x 15 / 20 x 19	8



MD497

GOELET Retractor

Catalog Number	Blade End	Length (in.)
MD497	DBL-END	7 1/2



BT010R

LUER Retractor

Catalog Number	Blade Size (mm)	Length (in.)
BT010R	10 x 8 / 12 x 11	4 3/8

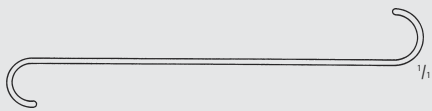

BT012R

CRILE Retractor

Catalog Number	Blade Size (mm)	Length (in.)
BT012R	11 x 4 / 19 x 6	4 3/8

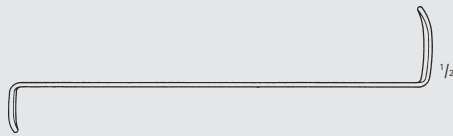

BT020R

FARABEUFR Retractor, 2/Set

Catalog Number	Blade Size (mm)	Length (in.)
BT020R	25 x 10 / 32 x 12 22 x 10 / 28 x 12	5
BT021R	23 x 16 / 28 x 16 20 x 16 / 24 x 16	6



BT021R

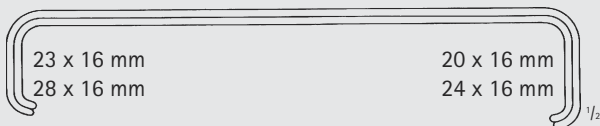

INCHES

General Surgery

Hand Held Retractors



BT022R

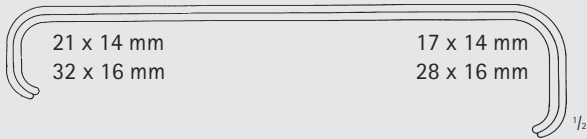

COLLIN Retractor, 2/Set

Catalog Number	Blade Size (mm)	Length (in.)
BT022R	21 x 14 / 32 x 16 17 x 14 / 28 x 16	6



MB727R-MB733R

CRILE Retractor

Catalog Number	Blade Size (mm)	Size	Length (in.)
MB727R	3 x 11 / 6 x 21	1	4 1/4
MB728R	6 x 13 / 10 x 21	2	6 1/8
MB729R	16 x 25 / 17 x 35	3	6 1/4
MB730R	22 x 29 / 29 x 44	4	7
MB731R	29 x 41 / 35 x 51	5	7
MB732R	32 x 64 / 35 x 70	6	8
MB733R	41 x 76 / 51 x 79	7	9



BT025R

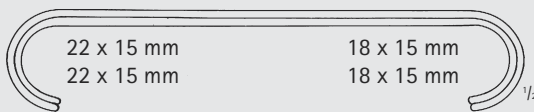

PARKER Retractor, 2/Set

Catalog Number	Blade Size (mm)	Length (in.)
BT025R	22 x 15 / 22 x 15 18 x 15 / 18 x 15	5 1/4



BT026R

1/2



26 x 44 mm
26 x 44 mm



30 x 24 mm
30 x 24 mm

1/1

**PARKER Retractor, 2/Set
(continued)**

Catalog Number	Blade Size (mm)	Length (in.)
BT026R	30 x 24 / 30 x 24 26 x 24 / 26 x 24	7

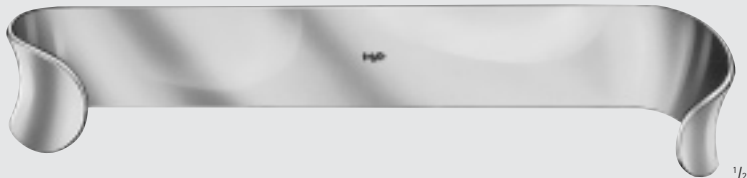

BT029R

1/2

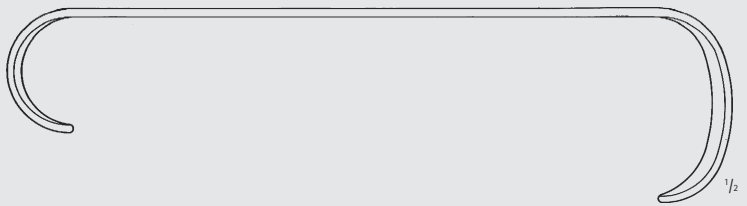

1/2

ROUX Retractor, Long

Catalog Number	Blade Size (mm)	Length (in.)
BT029R	28 x 28 / 46 x 28	7 1/2



BT036R

1/2

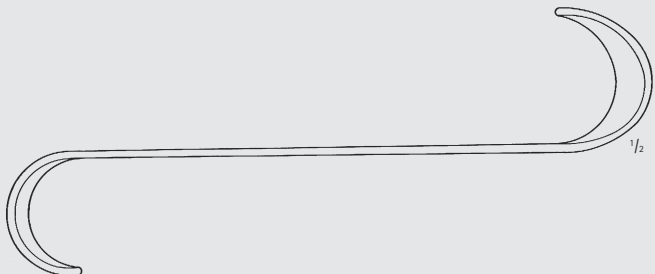

1/2

ROUX Retractor

Catalog Number	Blade Size (mm)	Length (in.)
BT036R	28 x 29 / 33 x 44	6 3/4



INCHES

General Surgery

Hand Held Retractors



BT030R-BT033R



BT031R



BT032R



BT033R



BT034R

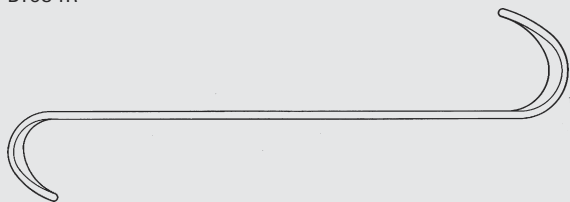

BT035R

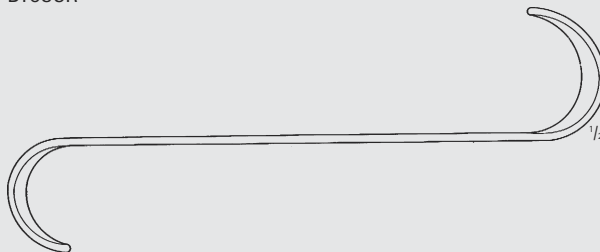

ROUX Retractor

Catalog Number	Blade Size (mm)	Length (in.)
BT030R	COMPLETE SET BT031R-BT033R	
BT031R	19 x 22 / 23 x 30	5 3/4
BT032R	25 x 26 / 28 x 38	6
BT033R	28 x 29 / 33 x 45	6 1/2
BT034R	20 x 22 / 25 x 29	6
BT035R	25 x 26 / 30 x 38	6 1/4

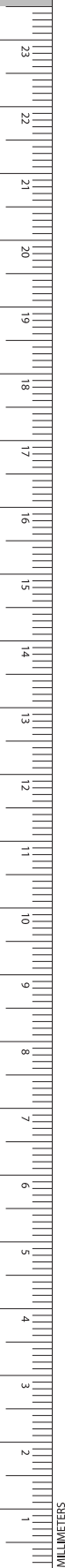



MB584R-MB585R

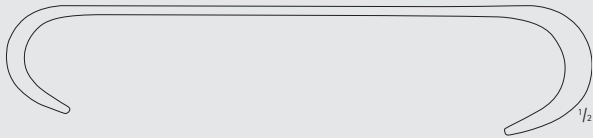

MB584R

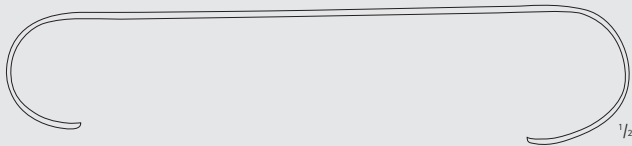

MB585R

ROUX Retractor

Catalog Number	Blade Size (mm)	Length (in.)
MB584R	25 x 35	6 1/2
MB585R	29 x 40	6 1/2



BT040R

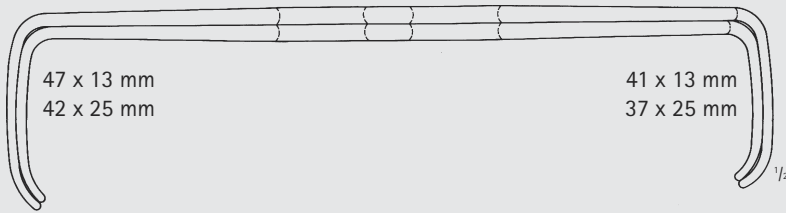

MATHIEU Retractor, 2/Set

Catalog Number	Blade Size (mm)	Length (in.)
BT040R	47 x 13 / 42 x 25 41 x 13 / 37 x 25	8



BT041R

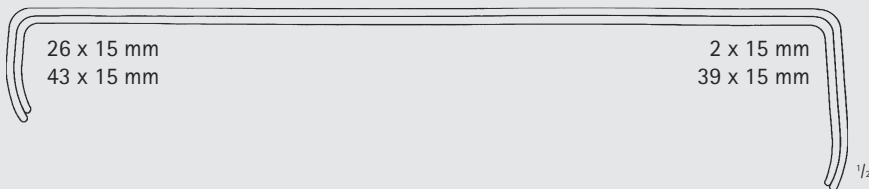

US-ARMY Retractor, 2/Set

Catalog Number	Blade Size (mm)	Length (in.)
BT041R	26 x 15 / 43 x 15 22 x 15 / 39 x 15	8 3/4



General Surgery

Hand Held Retractors

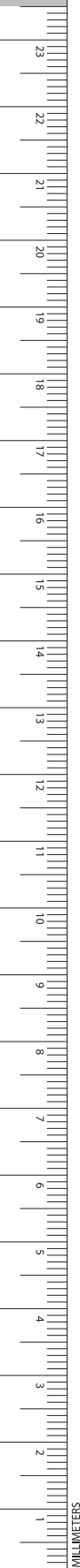

BT111R-BT114R $\frac{1}{2}$

BT111R $\frac{1}{4}$

BT113R $\frac{1}{4}$

Hook, Small Curve

Catalog Number	Tip	Blade End	Length (in.)
BT111R	SHARP	1 PRONG	6 1/2
BT112R	SHARP	2 PRONGS	6 1/2
BT113R	SHARP	3 PRONGS	6 1/2
BT114R	SHARP	4 PRONGS	6 1/2

BT112R

BT114R

BT116R-BT119R $\frac{1}{2}$

BT116R $\frac{1}{4}$

BT118R $\frac{1}{4}$

Hook, Small Curve

Catalog Number	Tip	Blade End	Length (in.)
BT116R	BLUNT	1 PRONG	6 1/2
BT117R	BLUNT	2 PRONGS	6 1/2
BT118R	BLUNT	3 PRONGS	6 1/2
BT119R	BLUNT	4 PRONGS	6 1/2

BT117R

BT119R

BT121R-BT124R $\frac{1}{2}$

BT121R $\frac{1}{4}$

BT123R $\frac{1}{4}$

Hook, Large Curve

Catalog Number	Tip	Blade End	Length (in.)
BT121R	SHARP	1 PRONG	6 1/2
BT122R	SHARP	2 PRONGS	6 1/2
BT123R	SHARP	3 PRONGS	6 1/2
BT124R	SHARP	4 PRONGS	6 1/2

BT122R

BT124R



Hook, Large Curve

Catalog Number	Tip	Blade End	Length (in.)
BT126R	BLUNT	1 PRONG	6 1/2
BT127R	BLUNT	2 PRONGS	6 1/2
BT128R	BLUNT	3 PRONGS	6 1/2
BT129R	BLUNT	4 PRONGS	6 1/2

Hook, Flex Shaft

Catalog Number	Tip	Blade End	Length (in.)
BT132R	SHARP	2 PRONGS	6
BT133R	SHARP	3 PRONGS	6
BT134R	SHARP	4 PRONGS	6

CRILLE Hook and Dissector

Catalog Number	Length (in.)
MB060R	11 3/4

Hook, Flex Shaft

Catalog Number	Tip	Blade End	Length (in.)
BT136R	BLUNT	2 PRONGS	6
BT137R	BLUNT	3 PRONGS	6
BT138R	BLUNT	4 PRONGS	6

MASING Retractor

Catalog Number	Blade Size (mm)	Length (in.)
OL211R	6 x 12	5 1/2

General Surgery

Hand Held Retractors

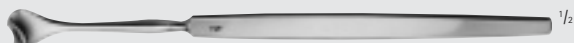

OL212R

COTTLE Retractor

Catalog Number	Blade Size (mm)	Length (in.)
OL212R	10 x 12	5 1/2



OA310R-OA314R

DESMARRES Lid Retractor

Catalog Number	Blade Size (mm)	Length (in.)
OA310R	9 x 9	5 1/2
OA311R	9 x 12	5 1/2
OA312R	11 x 14	5 1/2
OA313R	12 x 16	5 1/2
OA314R	13 x 18	5 1/2



OA310R



OA311R



OA312R



OA313R



OA314R



BT172R

KLAPP Tendon Hook

Catalog Number	Tip	Blade End	Blade Size (mm)	Length (in.)
BT172R	BLUNT	4 PRONGS	15 x 11	7

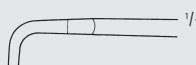

BT179R

Vein Retractor

Catalog Number	Blade Size (mm)	Length (in.)
BT179R	10 x 13	6 1/4

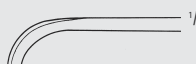

BT182R-BT183R

KOENIG Vein Retractor

Catalog Number	Blade Size (mm)	Length (in.)
BT182R	13 x 13	7
BT183R	12 x 16	7



BT182R



BT183R

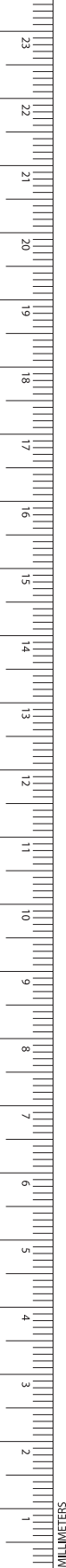

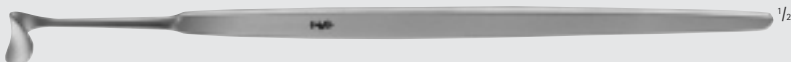

BT184R-BT185R

CUSHING Vein Retractor

Catalog Number	Blade Size (mm)	Length (in.)
BT184R	10 x 13	8
BT185R	14 x 18	8



BT184R



BT185R

Vein Retractor

Catalog Number	Blade Size (mm)	Length (in.)
BT207R	11	9 1/4

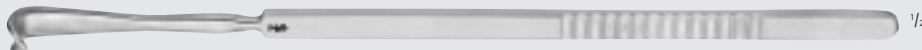

BT207R



GIL-VERNET Vein Retractor

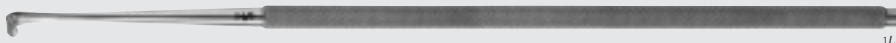

BT210R-BT217R

Catalog Number	Blade Size (mm)	Length (in.)
BT210R	10 x 4	9 1/2
BT211R	10 x 6	9 1/2
BT212R	10 x 8	9 1/2
BT213R	10 x 11	9 1/2
BT214R	13 x 15	9 1/2
BT215R	13 x 17	9 1/2
BT216R	14 x 20	9 1/2
BT217R	16 x 23	9 1/2

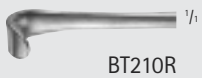

BT210R



BT211R



BT212R



BT213R

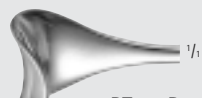

BT214R



BT215R



BT216R



BT217R



INCHES

General Surgery

Hand Held Retractors



CUSHING-KOCHER Retractor

Catalog Number	Blade Size (mm)	Length (in.)
BT190R	10 x 10	7



MEYERDING Thumb Retractor

Catalog Number	Blade Size	Size	Blade Size (mm)	Length (in.)
BT193R	A	#1	18 x 7	7
BT194R	B	#2	16 x 5	7
BT195R	C	#3	7 x 4	7
BT196R	D	#4	5 x 10	7
BT197R	E	#5	11 x 4	7
BT198R	F	#6	6 x 4	7

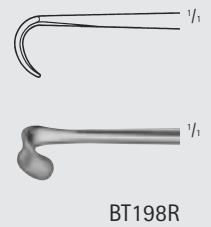
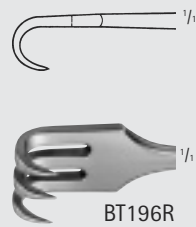
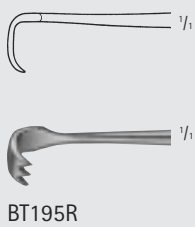
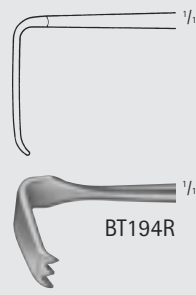
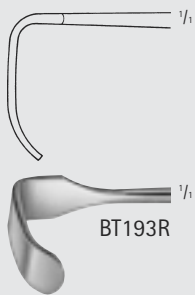

CUSHING Vein Retractor

Catalog Number	Blade Size (mm)	Length (in.)
BT200R	14 x 11	10
BT202R	22 x 15	10



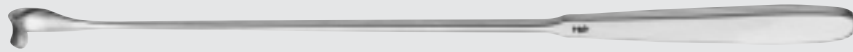

MB766R-MB769R

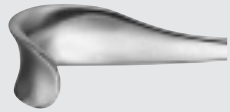

GIL-VERNET Retractor

Catalog Number	Blade Size (mm)	Length (in.)
MB766R	9	11 1/4
MB767R	11	11 1/4
MB768R	13	11 1/4
MB769R	18	11 1/4



BT221R

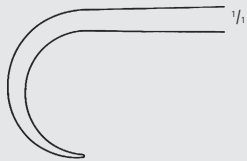

BT221R



BT222R-BT230R

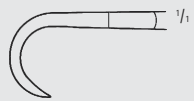

BT222R



BT223R



BT224R



BT225R

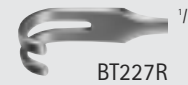
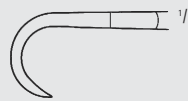

BT227R



BT228R



BT229R



BT230R

VOLKMANN Retractor

Catalog Number	Tip	Blade End	Blade Size (mm)	Length (in.)
BT221R	SHARP	1 PRONG	8.5 x 8	8 3/4
BT222R	SHARP	2 PRONGS	9 x 8	9
BT223R	SHARP	3 PRONGS	9 x 13	9
BT224R	SHARP	4 PRONGS	9 x 19	9
BT225R	SHARP	6 PRONGS	9 x 29	9
BT227R	BLUNT	2 PRONGS	8.5 x 8	9
BT228R	BLUNT	3 PRONGS	8.5 x 13	9
BT229R	BLUNT	4 PRONGS	9 x 8	9
BT230R	BLUNT	6 PRONGS	8.5 x 29	9



INCHES

General Surgery

Hand Held Retractors

GENL

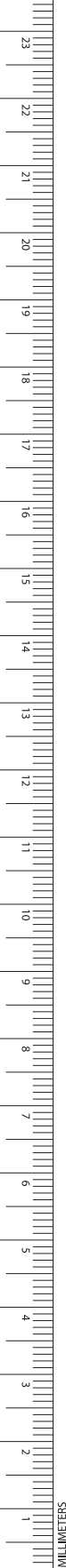

BT240R-BT241R

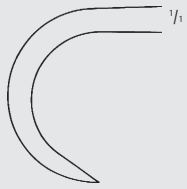

BT240R

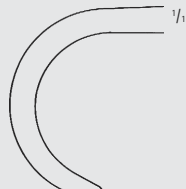

BT241R



BT242R-BT261R

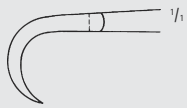

BT242R

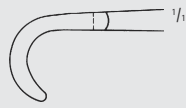

BT252R

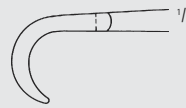

BT257R



BT243R



BT253R



BT259R

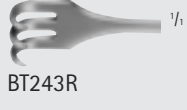

BT244R



BT254R



BT260R



BT246R



BT256R



BT261R



BT248R



BT258R



BT265R

VOLKMANN Retractor, Small

Catalog Number	Tip	Blade End	Blade Size (mm)	Length (in.)
BT240R	SHARP	1 PRONG		8 3/4
BT241R	BLUNT	1 PRONG		8 3/4
BT242R	SHARP	2 PRONGS	9 x 8	8 3/4
BT243R	SHARP	3 PRONGS	9 x 13	8 3/4
BT244R	SHARP	4 PRONGS	9 x 19	8 3/4
BT246R	SHARP	6 PRONGS	9 x 29	8 3/4
BT248R	SHARP	8 PRONGS	9 x 40	8 3/4
BT252R	BLUNT	2 PRONGS	8 x 8	8 3/4
BT253R	BLUNT	3 PRONGS	8 x 13	8 3/4
BT254R	BLUNT	4 PRONGS	8 x 19	8 3/4
BT256R	BLUNT	6 PRONGS	8 x 29	8 3/4
BT258R	BLUNT	8 PRONGS	8 x 13	8 3/4
BT265R	SEMI-S	8 PRONGS	8.5 x 40	8 3/4
BT257R	SEMI-S	2 PRONGS	8.5 x 8	8 3/4
BT259R	SEMI-S	3 PRONGS	8.5 x 13	8 3/4
BT260R	SEMI-S	4 PRONGS	8.5 x 19	8 3/4
BT261R	SEMI-S	6 PRONGS	8.5 x 29	8 3/4



BT262R-BT276R

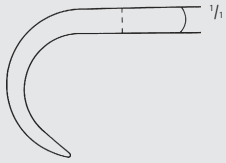

BT262R



BT263R



BT264R



BT266R

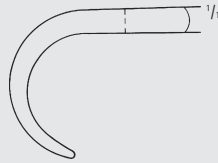

BT272R



BT273R



BT274R



BT276R

KOCHER Retractor, Large

Catalog Number	Tip	Blade End	Blade Size (mm)	Length (in.)
BT262R	2 PRONGS	SEMI-S	16 x 9	8 3/4
BT263R	3 PRONGS	SEMI-S	16 x 14	8 3/4
BT264R	4 PRONGS	SEMI-S	16 x 20	8 3/4
BT266R	6 PRONGS	SEMI-S	16 x 30	8 3/4
BT272R	2 PRONGS	BLUNT	15.5 x 9	8 3/4
BT273R	3 PRONGS	BLUNT	15.5 x 14	8 3/4
BT274R	4 PRONGS	BLUNT	15.5 x 20	8 3/4
BT276R	6 PRONGS	BLUNT	15.5 x 30	8 3/4

KOERTE Retractor

Catalog Number	Tip	Blade End	Blade Size (mm)	Length (in.)
BT278R	BLUNT	8 PRONGS	26 x 40	9 1/2
BT279R	SEMI-S	8 PRONGS	26 x 40	9 1/2



BT278R-BT279R

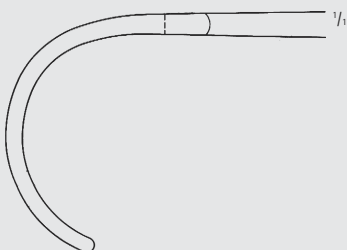

BT278R

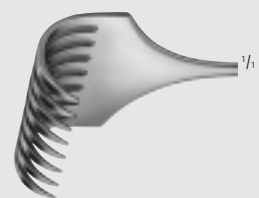

BT279R



INCHES

General Surgery
Hand Held Retractors

ISRAEL Retractor

Catalog Number	Tip	Blade End	Blade Size (mm)	Length (in.)
BT284R	BLUNT	4 PRONGS	39 x 40	10
BT285R	BLUNT	5 PRONGS	47 x 51	10
BT286R	BLUNT	6 PRONGS	53 x 62	10
BT287R	BLUNT	6 PRONGS	70 x 70	10



BT284R-BT287R

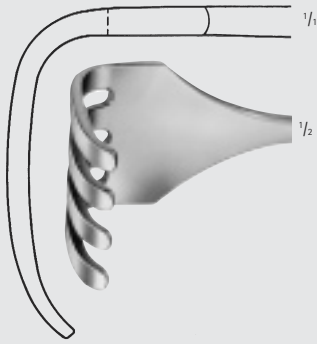

BT284R

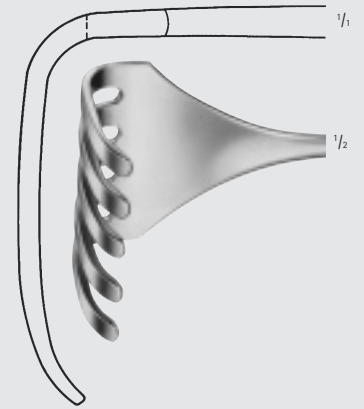

BT285R

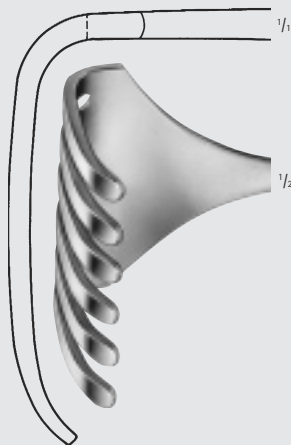

BT286R

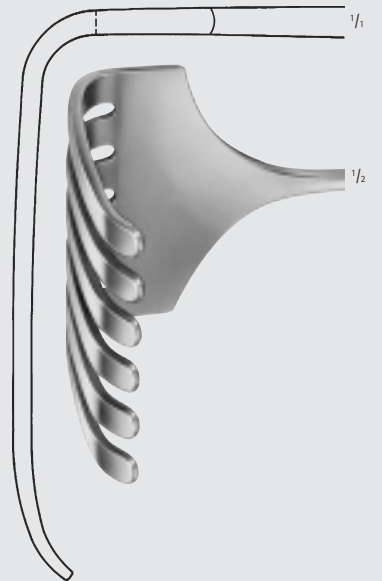

BT287R

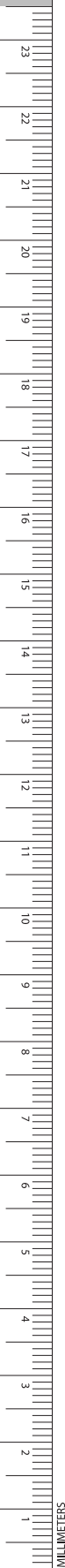

MURPHY Retractor

Catalog Number	Tip	Blade End	Length (in.)
BT293R	SHARP	3 PRONGS	7 3/4
BT294R	SHARP	4 PRONGS	7 3/4
BT295R	BLUNT	3 PRONGS	7 3/4
BT296R	BLUNT	4 PRONGS	7 3/4

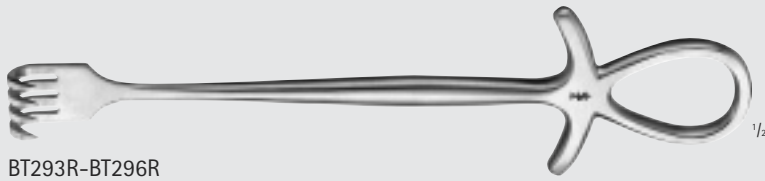

BT293R-BT296R



BT293R



BT294R



BT295R



BT296R

KOERTE-WAGNER Retractor

Catalog Number	Tip	Blade End	Blade Size (mm)	Length (in.)
BT290R	SEMI-S	8 PRONGS	28 x 40	11

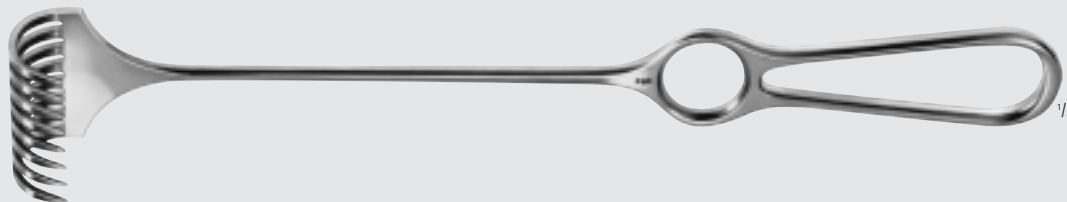

BT290R

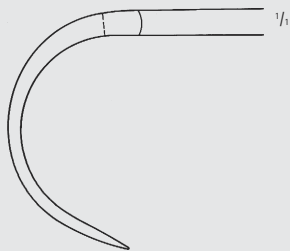

INCHES

General Surgery
Hand Held Retractors



LANGENBECK Retractor

Catalog Number	Blade Size (mm)	Length (in.)
BT311R	30 x 10	9
BT315R	40 x 10	9
BT316R	43 x 13	9

BT311R-BT316R

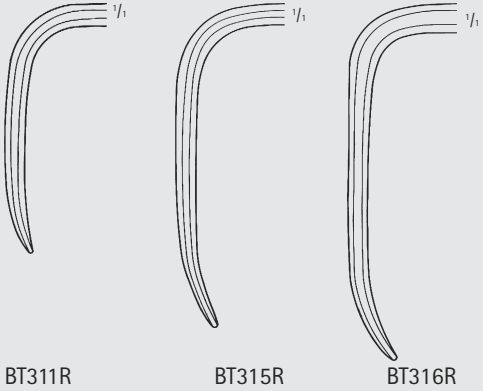

BT311R

BT315R

BT316R

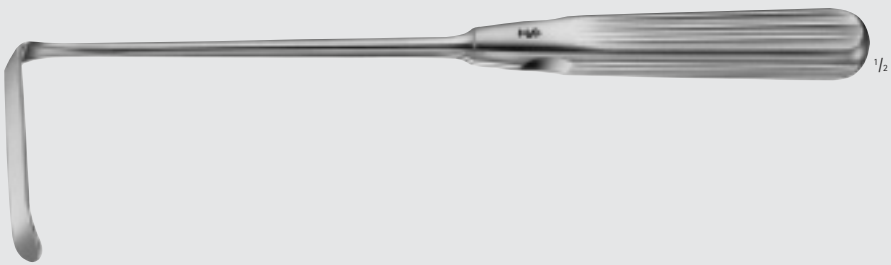

SAUERBRUCH Retractor

Catalog Number	Blade Size (mm)	Length (in.)
BT351R	46 x 16	9
BT352R	55 x 22	9
BT353R	72 x 19	9

BT351R-BT353R

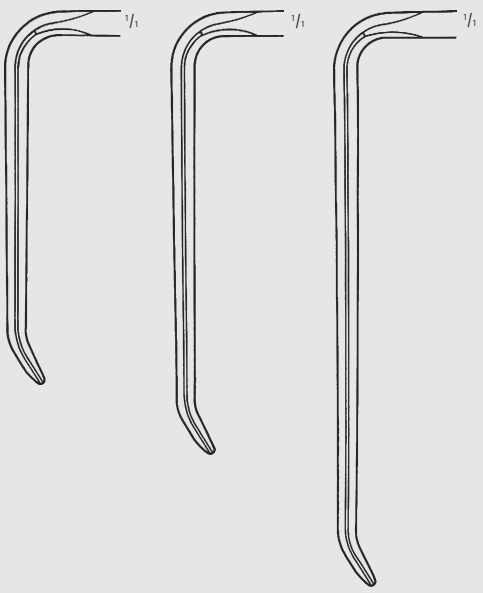

BT351R

BT352R

BT353R

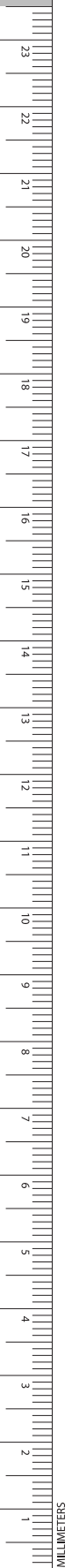



BT354R-BT365R

KOCHER-LANGENBECK Retractor

Catalog Number	Blade Size (mm)	Length (in.)
BT354R	25 x 6	8 1/2
BT356R	35 x 8	8 1/2
BT357R	35 x 11	8 1/2
BT358R	35 x 15	8 1/2
BT359R	41 x 11	8 1/2
BT361R	55 x 11	8 1/2
BT363R	70 x 14	8 1/2
BT364R	80 x 12	8 1/2
BT365R	80 x 16	8 1/2

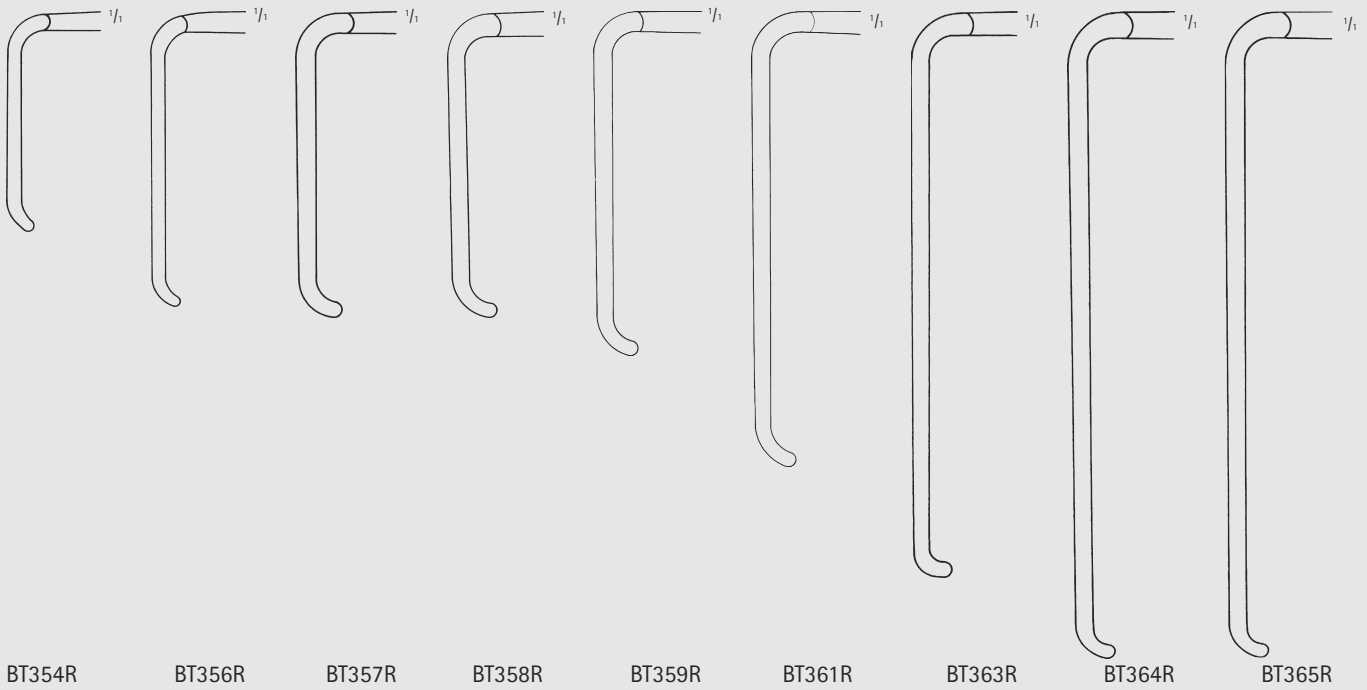

BT354R

BT356R

BT357R

BT358R

BT359R

BT361R

BT363R

BT364R

BT365R



INCHES

General Surgery

Hand Held Retractors



MB785R

LAHEY Goiter Retractor

Catalog Number	Blade Size (mm)	Length (in.)
MB785R	24 x 8	8



BT404R-BT406R



BT404R

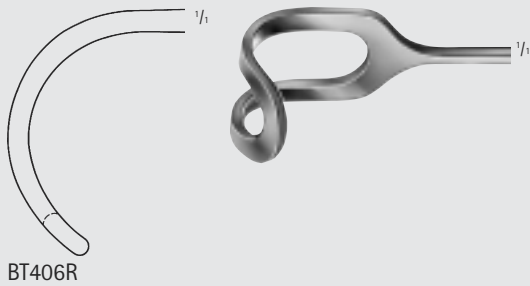

BT406R

MIDDELDORPF Retractor

Catalog Number	Blade Size (mm)	Length (in.)
BT404R	15 x 15	8 3/4
BT405R	20 x 22	8 1/2
BT406R	28 x 28	9 1/4

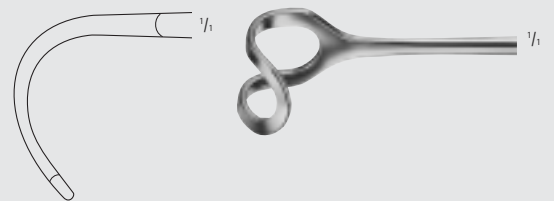

BT405R



BT408R

GREENE Retractor

Catalog Number	Blade Size (mm)	Length (in.)
BT408R	22 x 22	9

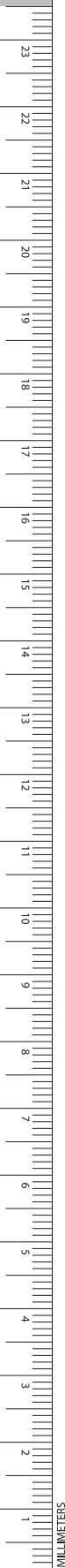
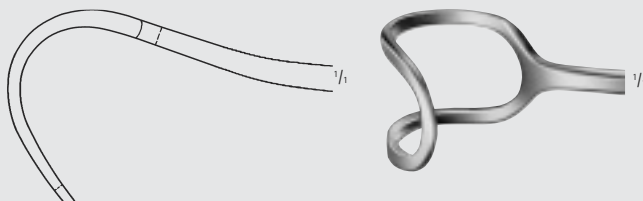



DOCKHORN Cheek Retractor

Catalog Number	Blade Size (mm)	Length (in.)
D0438R	40 x 12	8 1/4
D0439R	55 x 14	8 1/4

D0438R-D0439R



D0438R



D0439R



General Surgery

Abdominal Retractors



HOESEL Retractor

Catalog Number	Blade Size (mm)	Length (in.)
BT442R	100 x 30	10
BT446R	220 x 40	10

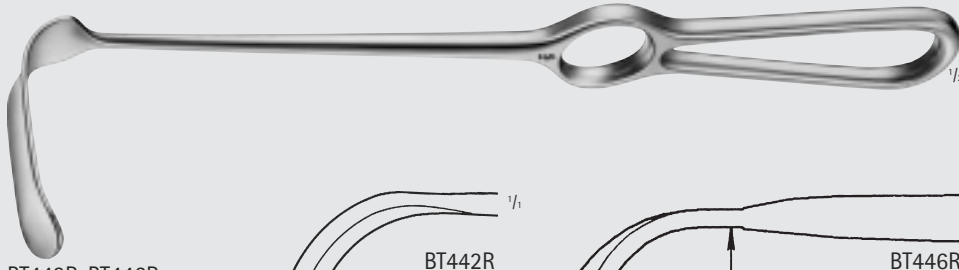

BT442R-BT446R

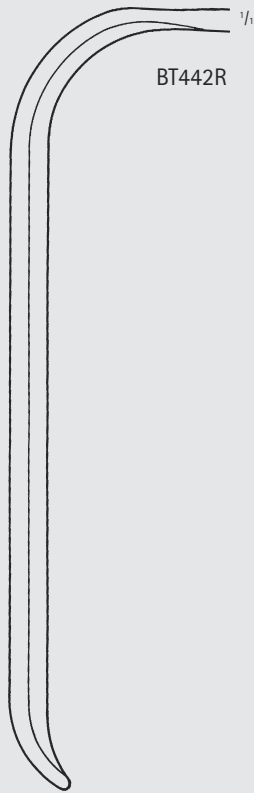

BT442R

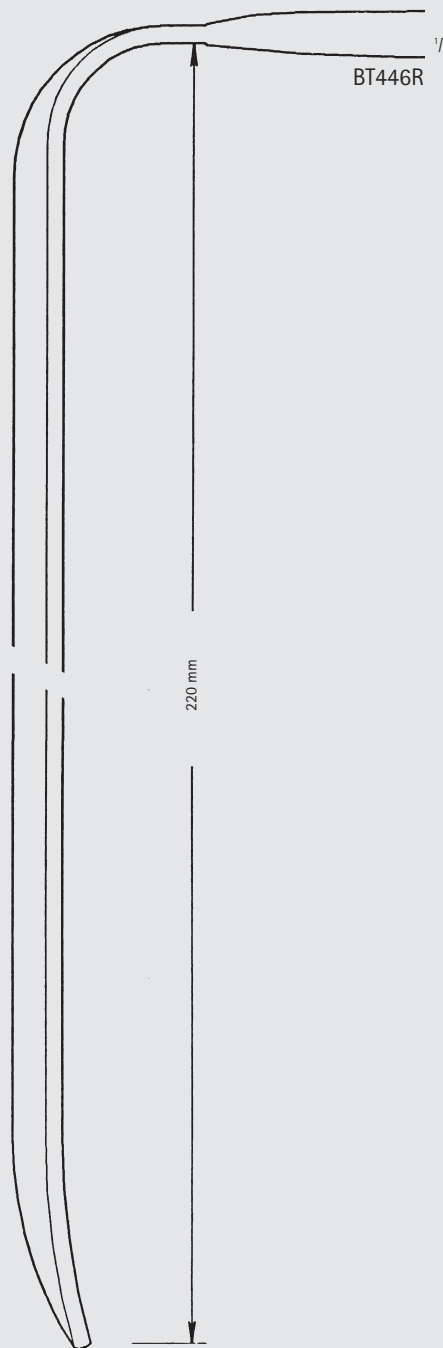

BT446R

220 mm

KOCHER Retractor

Catalog Number	Blade Size (mm)	Length (in.)
BT461R	80 x 42	10
BT462R	80 x 50	10
BT463R	80 x 60	10

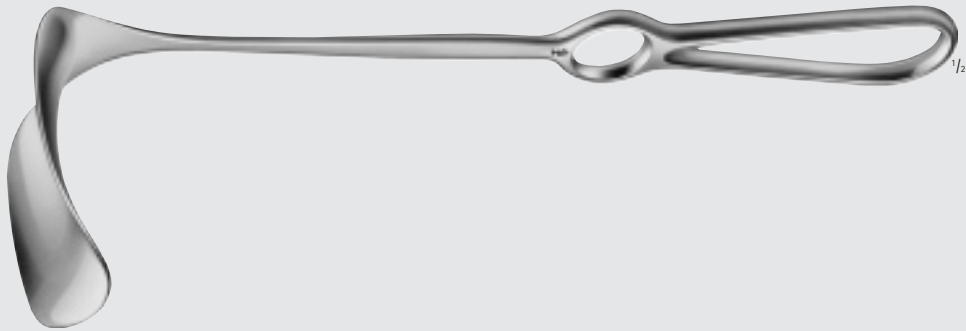

BT461R-BT463R

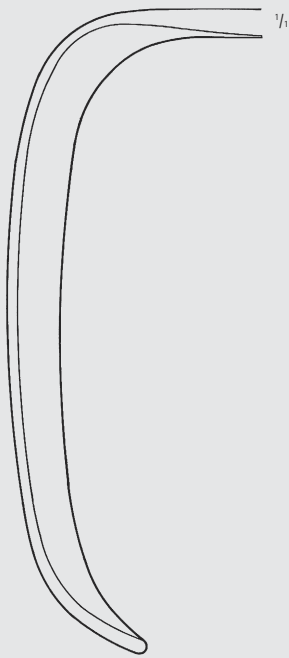

INCHES

General Surgery

Abdominal Retractors

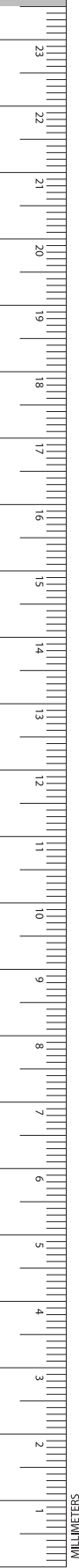

BT464R



KRAEMER Retractor

Catalog Number	Blade Size (mm)	Length (in.)
BT464R	66 x 10	8 1/4



BT465R



CASPAR Retractor

Catalog Number	Blade Size (mm)	Length (in.)
BT465R	67 x 17	8 1/4



BT450R-BT469R

MIASPAS Mini-Alif LANGENBECK Retractor

Catalog Number	Blade Size (mm)	Length (in.)
BT450R	125 x 20	8 1/4
BT451R	125 x 35	8 1/4
BT466R	80 x 20	8 1/4
BT467R	110 x 20	8 1/4
BT468R	80 x 35	8 1/4
BT469R	110 x 35	8 1/4

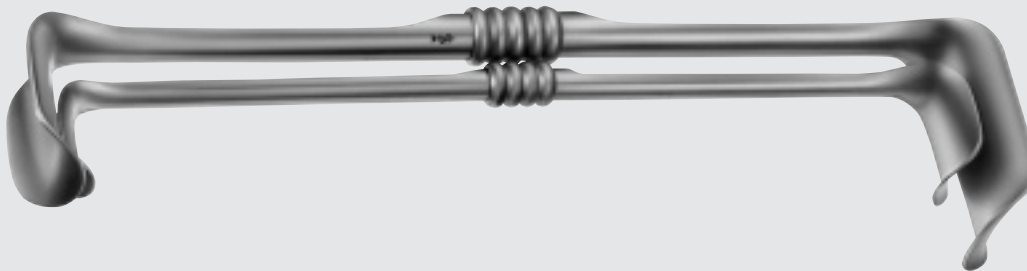

BT470R-BT472R

RICHARDSON-EASTMAN Retractor

Catalog Number	Item	Tip	Length (in.)
BT470R	2/SET (BT471R, BT472R)	-	
BT471R	-	SM	10
BT472R	-	LRG	10 3/4

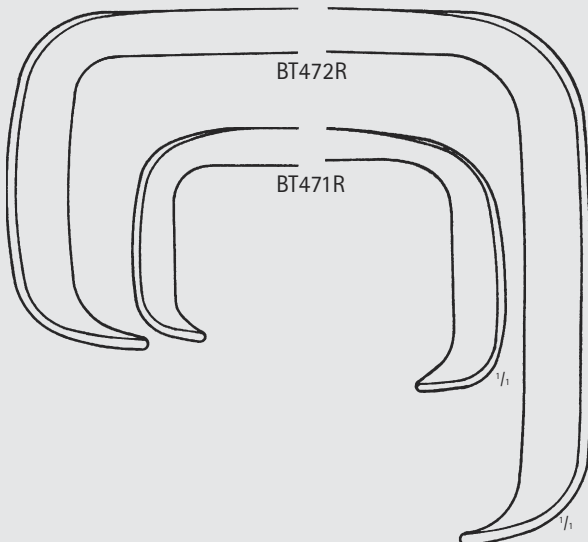

INCHES

General Surgery

Abdominal Retractors



BT475R-BT477R

RICHARDSON Retractor

Catalog Number	Blade Size (mm)	Blade Size (in.)	Length (in.)
BT475R	23 x 20	1 x 3/4	9 1/2
BT476R	30 x 29	1 1/4 x 1 1/8	9 1/2
BT477R	37 x 37	1 1/2 x 1 1/2	9 1/2
BT478R	47 x 21	2 x 3/4	9 1/2

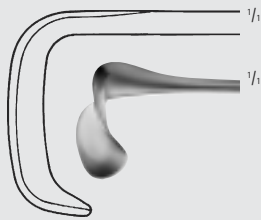

BT475R

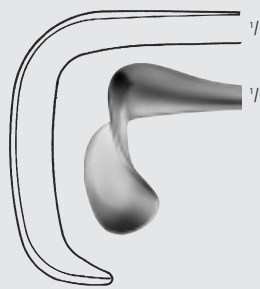

BT476R

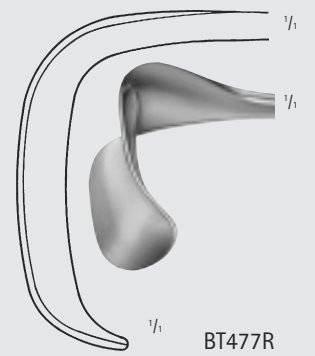

BT477R



BT478R

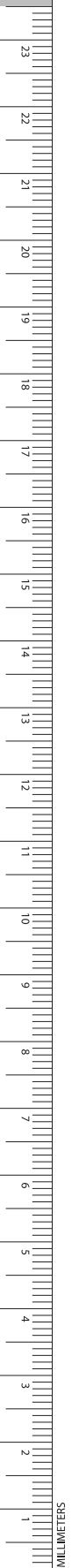
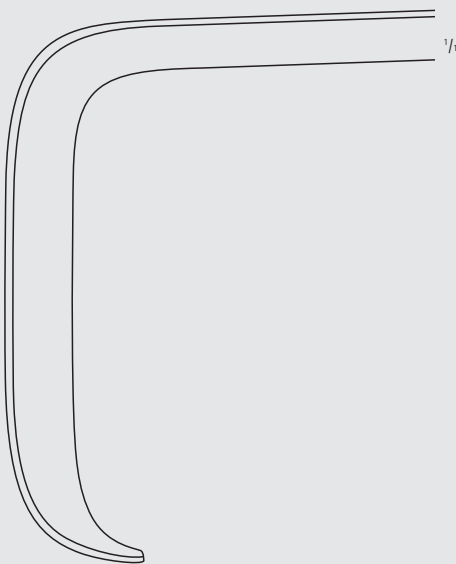

General Surgery

Abdominal Retractors

GENL

RICHARDSON Retractor

Catalog Number	Blade Size (mm)	Blade Size (in.)	Length (in.)
BT479R	65 x 41	2 1/2 x 1 5/8	10



General Surgery
Abdominal Retractors

KELLY Retractor

Catalog Number	Blade Size (mm)	Blade Size (in.)	Length (in.)
BT481R	50 x 40	2 x 1 1/2	10 1/4
BT482R	64 x 54	2 1/2 x 2	10 1/4
BT483R	70 x 65	2 3/4 x 2 1/2	10 1/4
BT484R	90 x 76	3 1/2 x 3	10 1/4

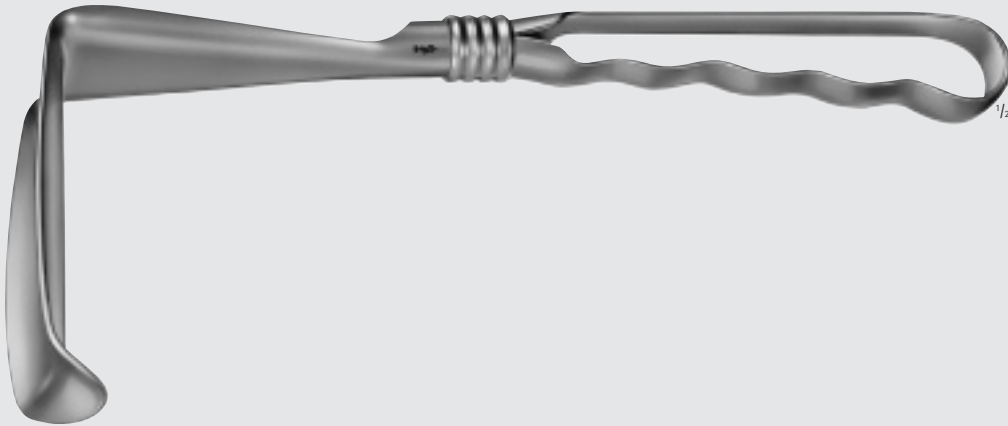

BT481R-BT484R



BT481R

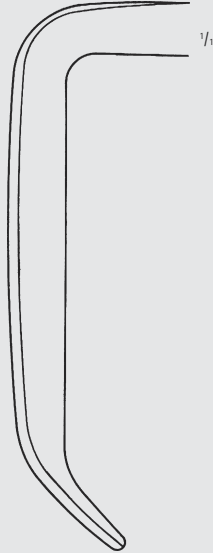

BT482R



BT483R

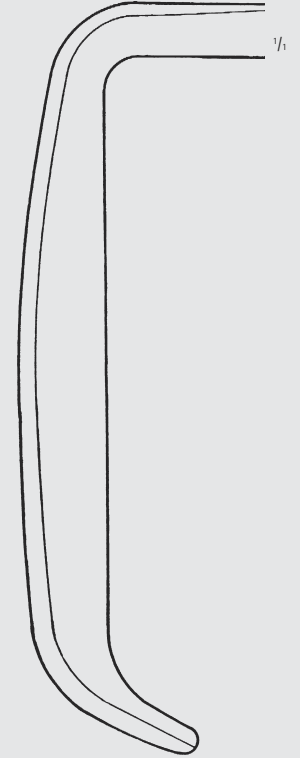

BT484R

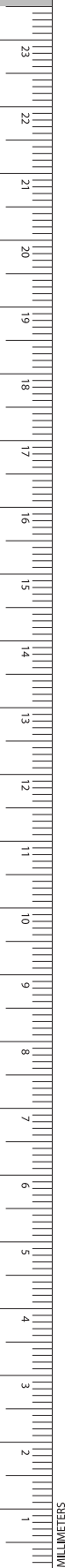

General Surgery
Abdominal Retractors

GENL

SAUERBRUCH Retractor, Open

Catalog Number	Blade Size (mm)	Length (in.)
BT514R	130 x 38	10 1/4

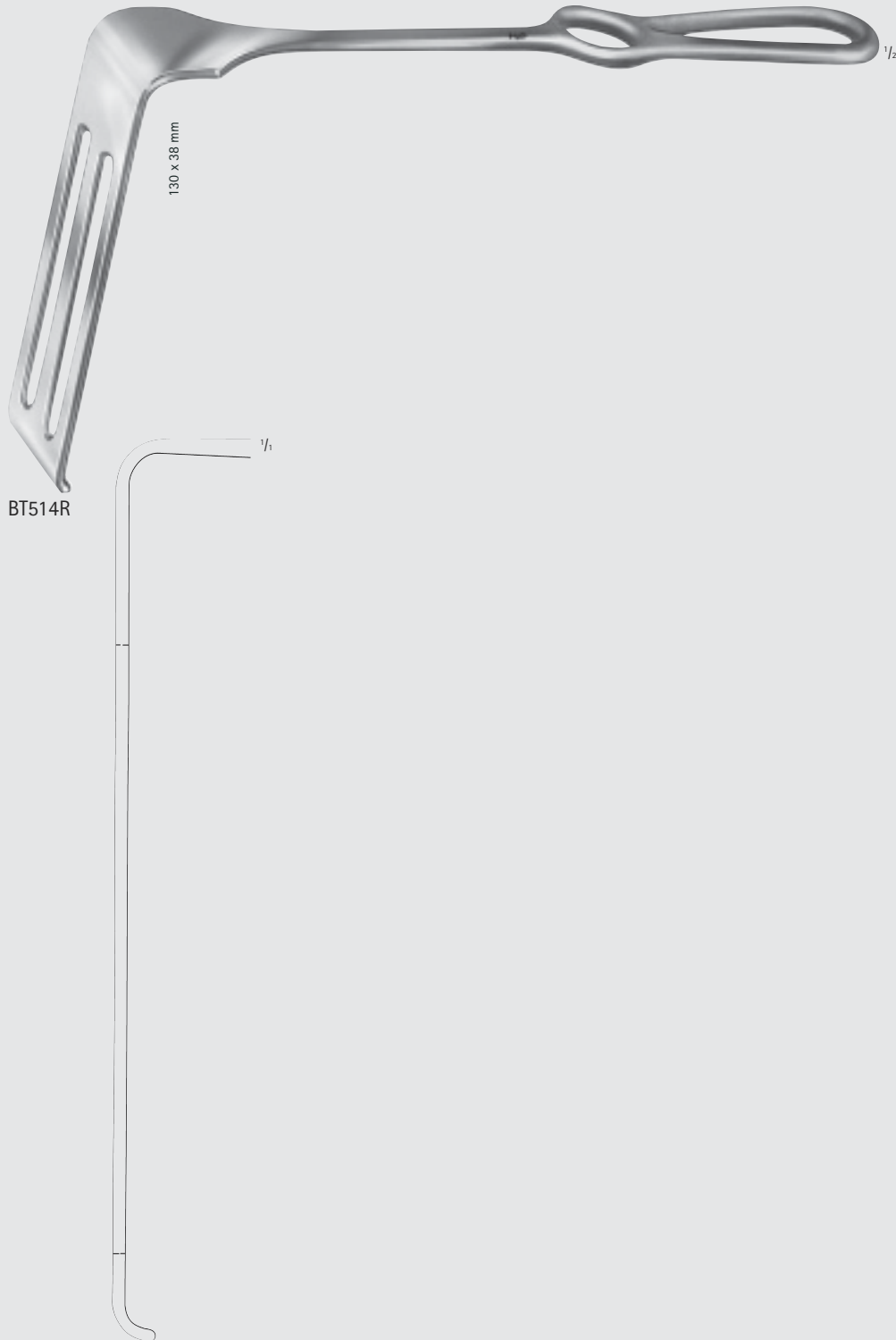

INCHES

General Surgery

Abdominal Retractors

HARRINGTON Lung Spatula

Catalog Number	Blade Size (mm)	Blade End	Length (in.)
BT551R	123 x 45	FLEX	11 3/4
BT552R	123 x 64	FLEX	11 3/4

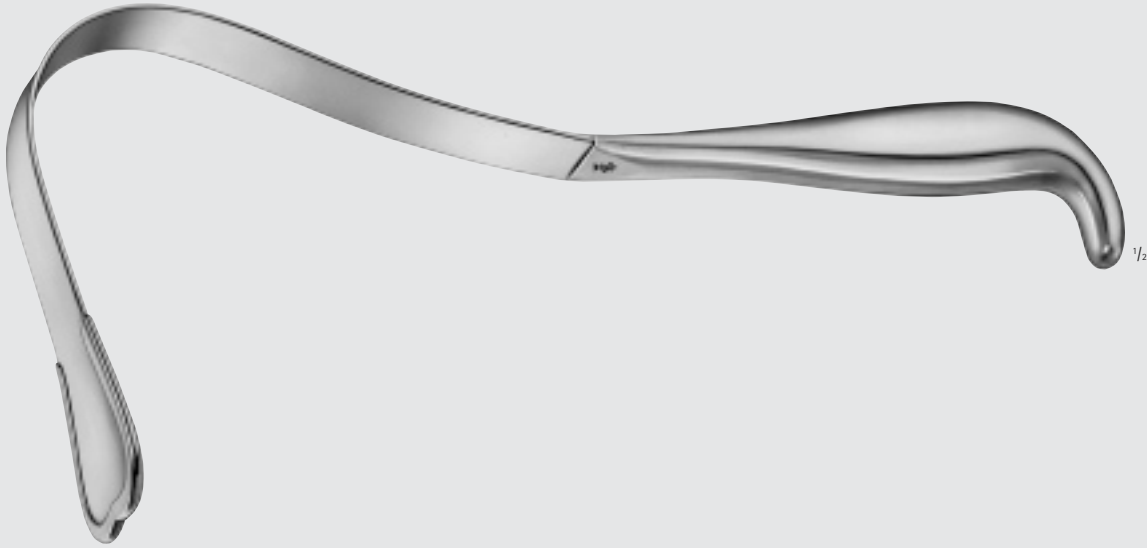

BT551R-BT552R

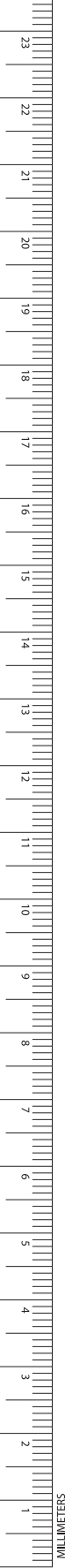
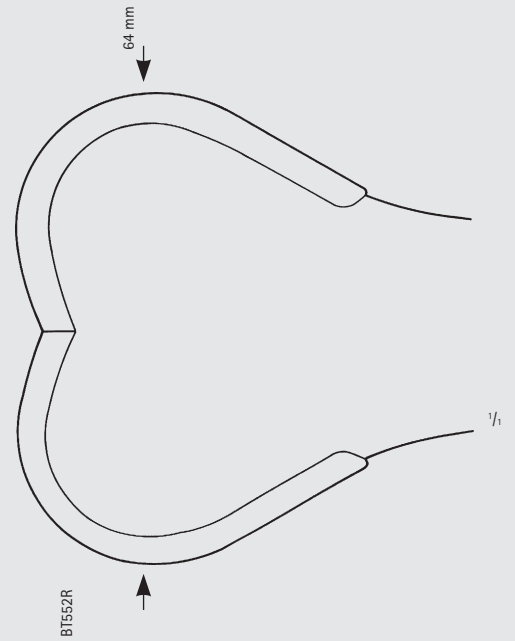
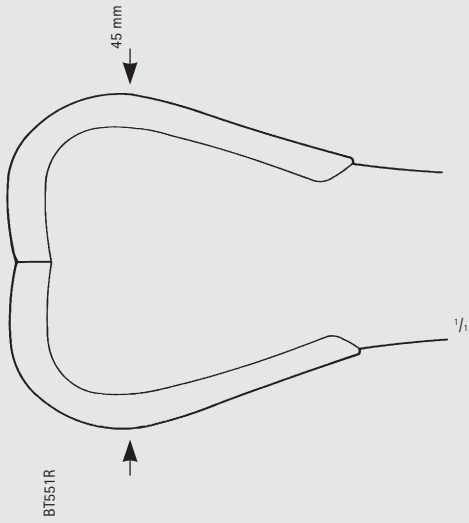

HARRINGTON-PEMBERTON Lung
Spatula

Catalog Number	Blade Size (mm)	Blade End	Length (in.)
BT553R	175 x 64	FLEX	11 3/4



BT553R

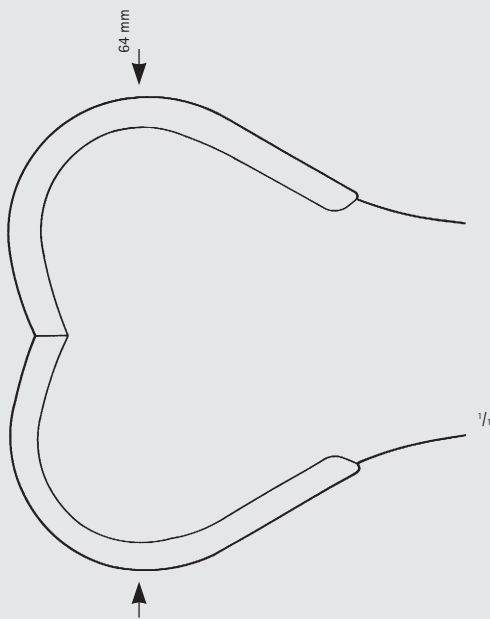

INCHES

General Surgery

Abdominal Retractors

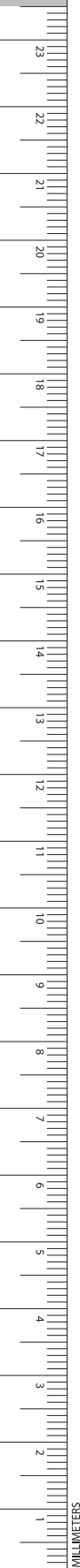

ZENKER Retractor

Catalog Number	Blade Size (mm)	Length (in.)
BT594R	36 x 8	9 1/2
BT595R	60 x 12	10
BT596R	75 x 12	10 3/4
BT597R	120 x 12	11 1/2



BT594R-BT597R

1/2

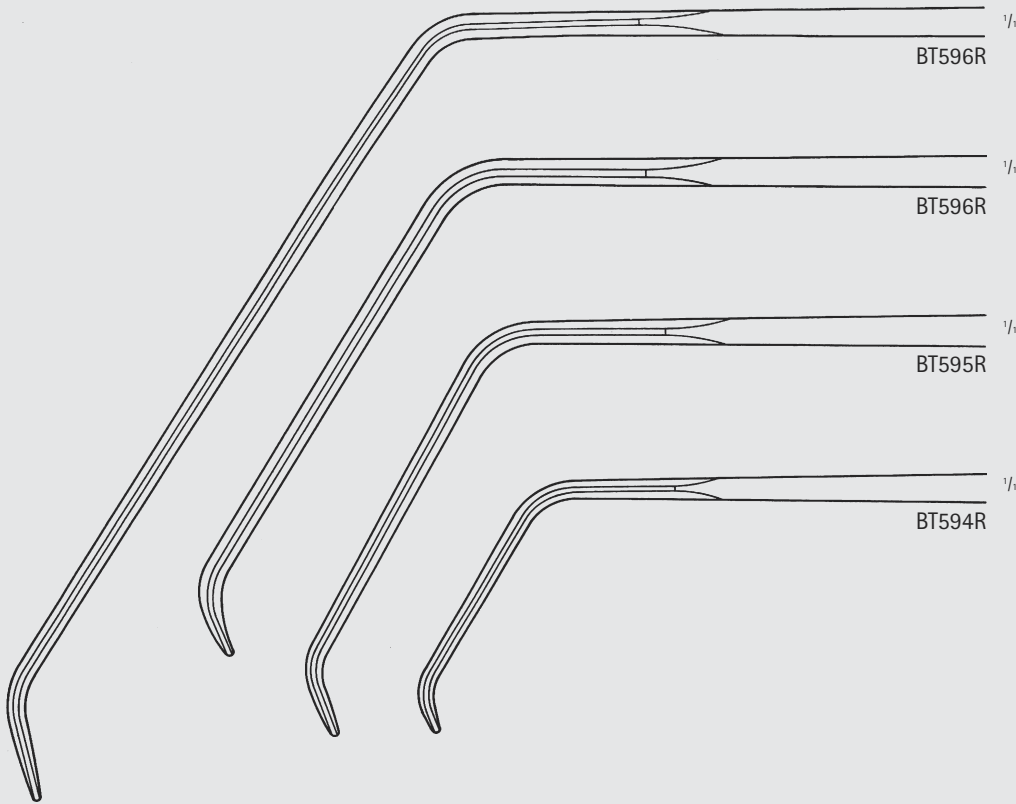

1/4

BT596R

1/4

BT596R

1/4

BT595R

1/4

BT594R

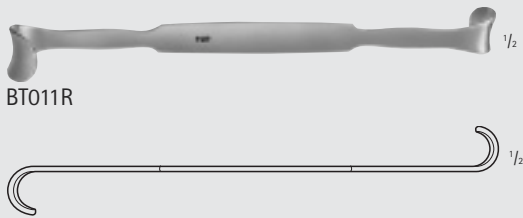

BT011R

ROSE Retractor

Catalog Number	Blade Size (mm)	Length (in.)
BT011R	10 x 12 / 11 x 15	5 1/8

Abdominal retractors for exposure of the abdominal aorta

- To be used in pairs:
- left side: small retractor (BT640R-BT642R)
- right side: large retractor (BT643R-BT645R)
- to keep away organs and tissue, e.g. intestine

VOLLMAR Abdominal Retractor

Catalog Number	Blade	Blade Size (mm)	Length (in.)
BT640R	LEFT, SMALL	110 x 60	12 3/4
BT641R	LEFT, SMALL	120 x 60	12 3/4
BT642R	LEFT, SMALL	130 x 60	12 3/4
BT643R	RIGHT, LARGE	120 x 110	12 3/4
BT644R	RIGHT, LARGE	140 x 110	12 3/4
BT645R	RIGHT, LARGE	160 x 110	12 3/4



BT640R-BT645R



INCHES

General Surgery

Abdominal Retractors

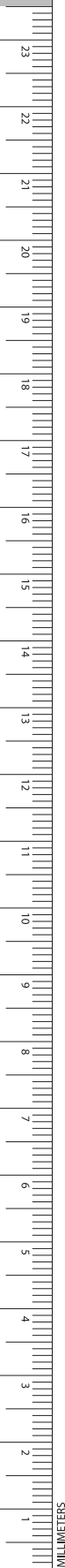

DEAVER Retractor

Catalog Number	Blade Size (mm)	Blade Size (in.)	Length (in.)
BT600R	19	3/4	7

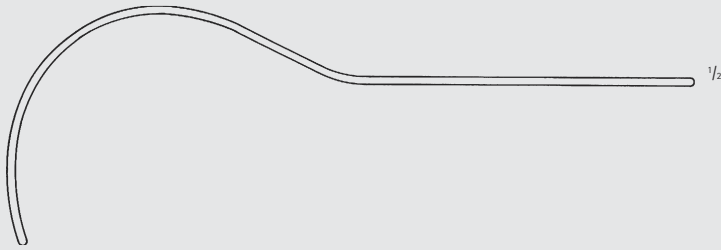

DEAVER Retractor, Double End

Catalog Number	Blade Size (mm)	Blade Size (in.)	Length (in.)
BT606R	25	1	9 1/4



DEAVER Retractor

Catalog Number	Blade Size (mm)	Blade Size (in.)	Length (in.)
BT601R	22	7/8	8 1/2
BT602R	25	1	12
BT603R	25	1	12 1/2



BT601R

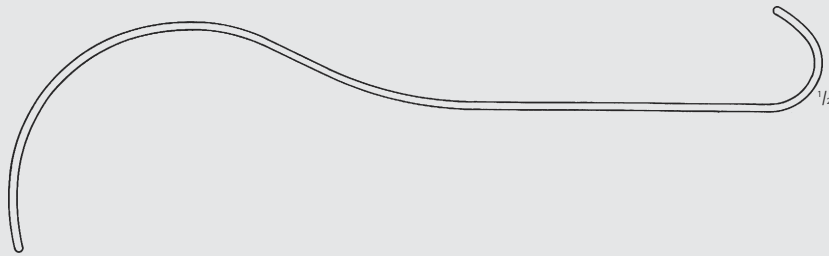

BT602R-BT603R

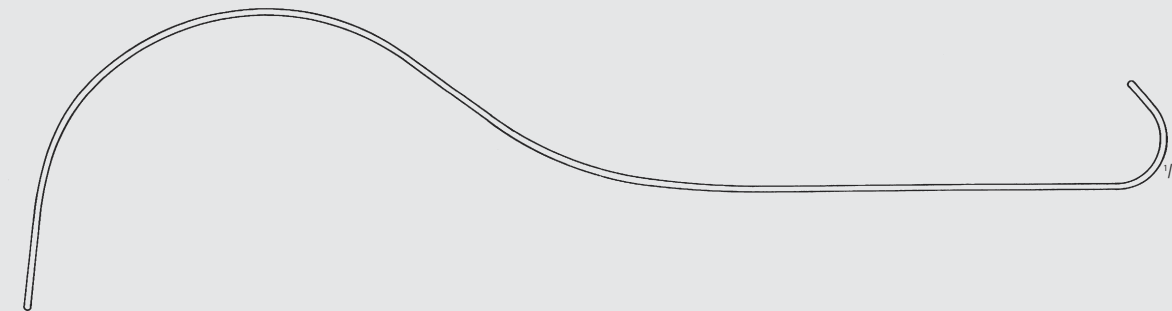

BT602R

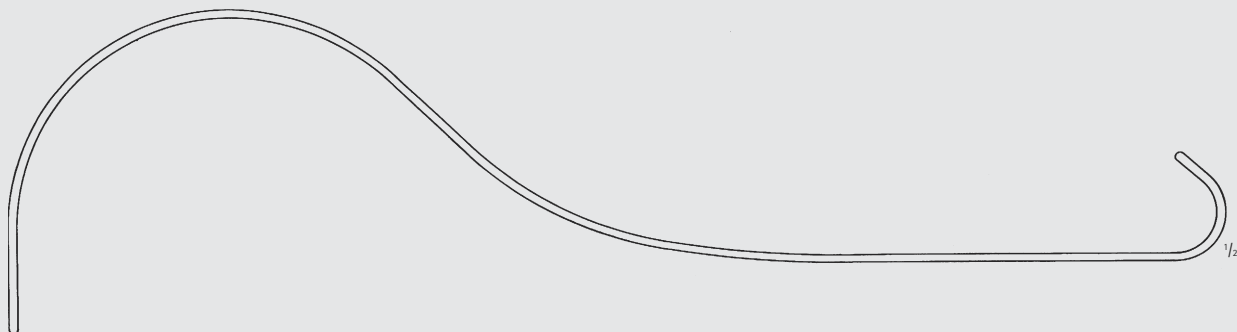

BT603R



INCHES

General Surgery

Abdominal Retractors

DEAVER Retractor (continued)

Catalog Number	Blade Size (mm)	Blade Size (in.)	Length (in.)
BT604R	38	1 1/2	12

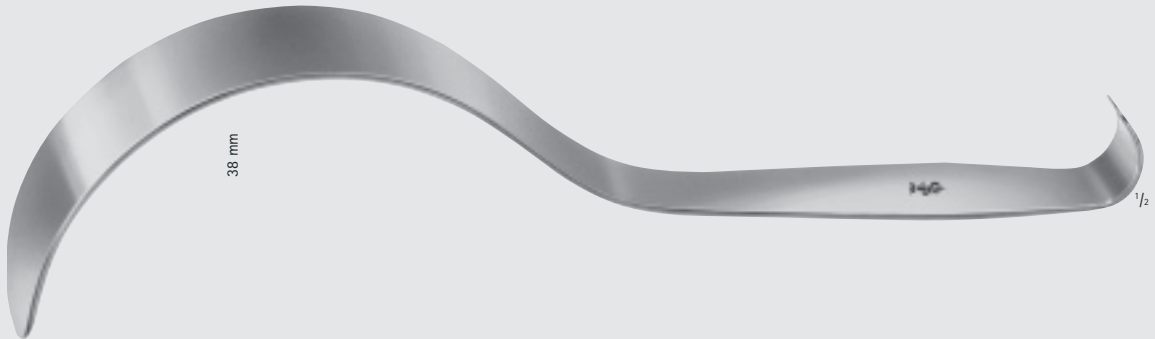

BT604R

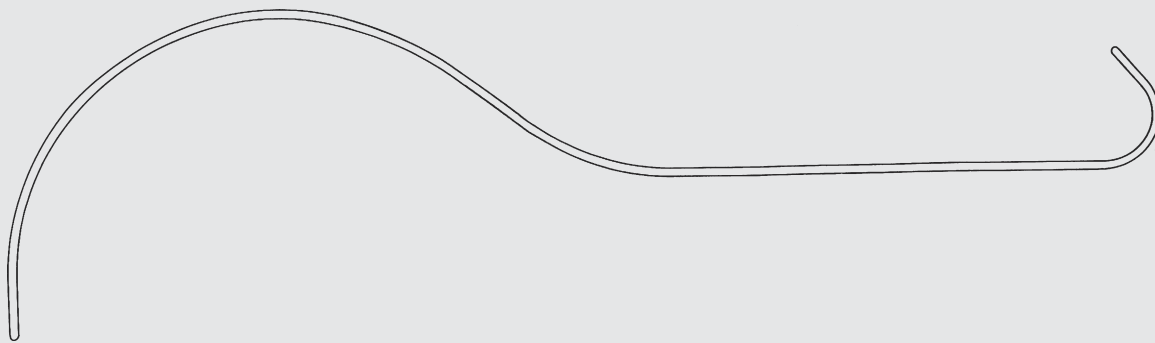

DEAVER Retractor
(continued)

Catalog Number	Blade Size (mm)	Blade Size (in.)	Length (in.)
BT605R	50	2	12 1/4
BT607R	25	1	14 1/2

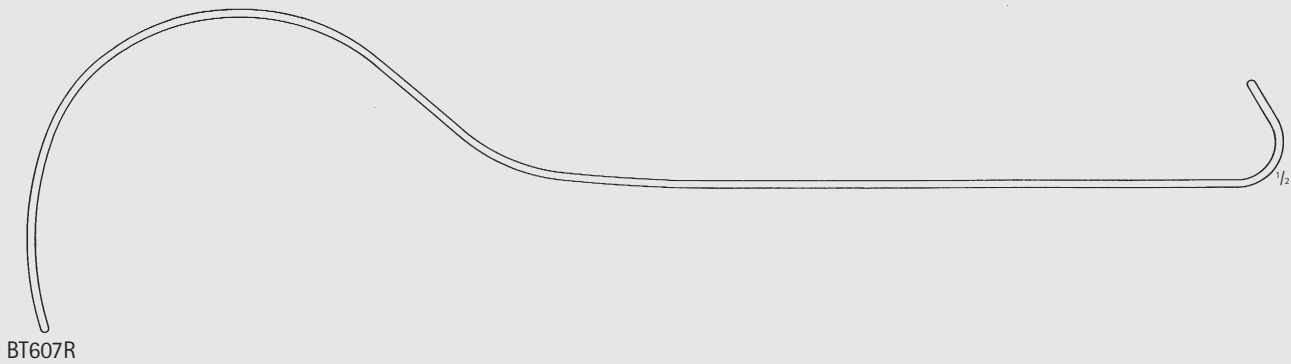
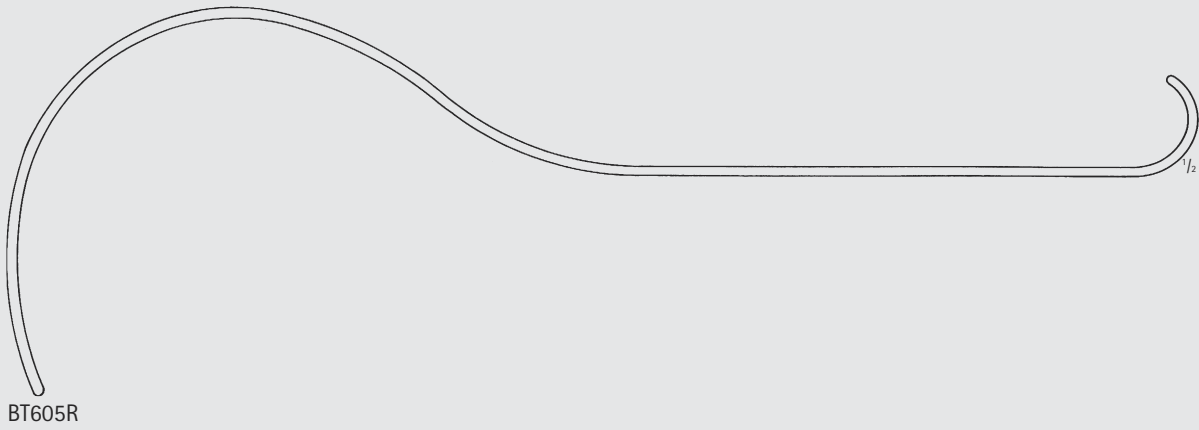

INCHES

General Surgery

Abdominal Retractors



DEAVER Retractor
(continued)

Catalog Number	Blade Size (mm)	Blade Size (in.)	Length (in.)
BT608R	75	3	12 3/4

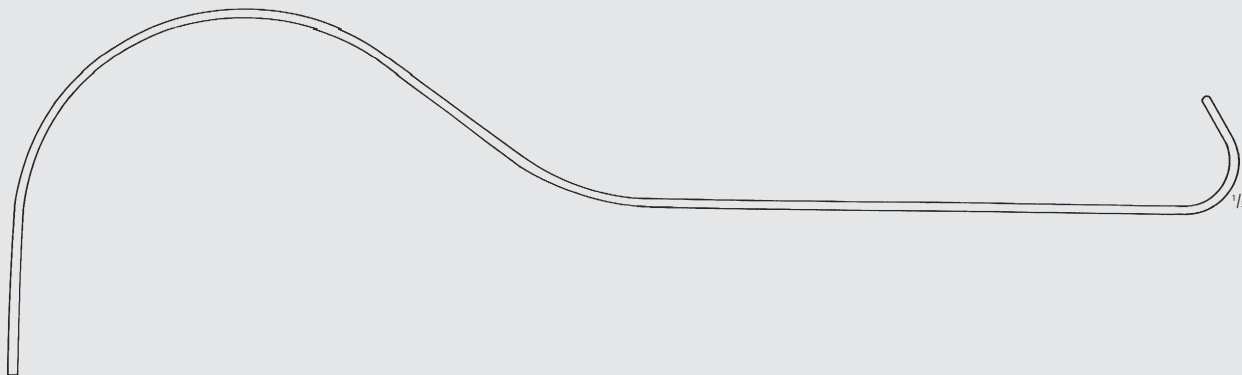
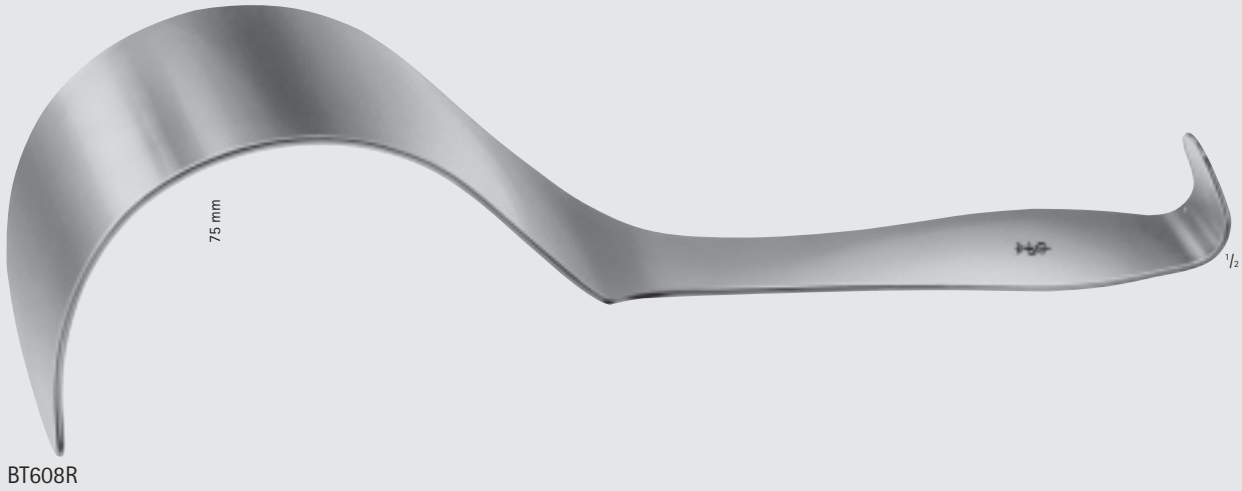

DEAVER Retractor, W/Grip

Catalog Number	Blade Size (mm)	Blade Size (in.)	Length (in.)
BT611R	25	1	12 1/4
BT613R	38	1 1/2	12 1/4



BT611R-BT613R

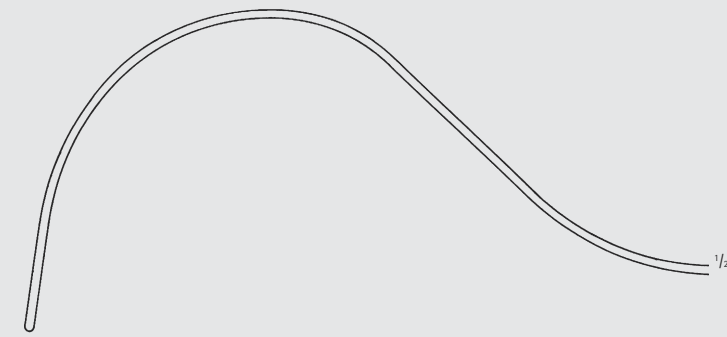

BT611R

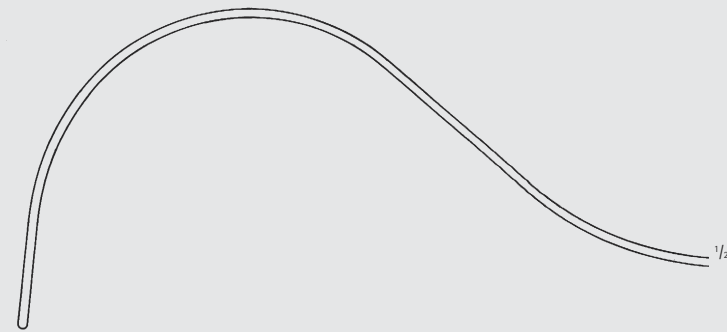

BT613R



General Surgery

Abdominal Retractors

DEAVER Retractor, W/Grip
(continued)

Catalog Number	Blade Size (mm)	Blade Size (in.)	Length (in.)
BT614R	50	2	12

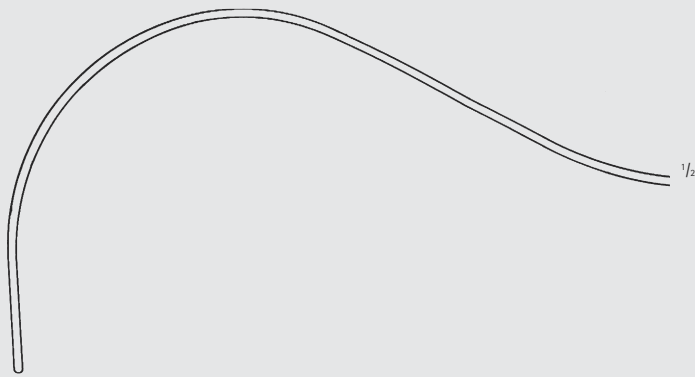

DEAVER Retractor, W/Grip
(continued)

Catalog Number	Blade Size (mm)	Blade Size (in.)	Length (in.)
BT615R	75	3	12 1/4



BT615R

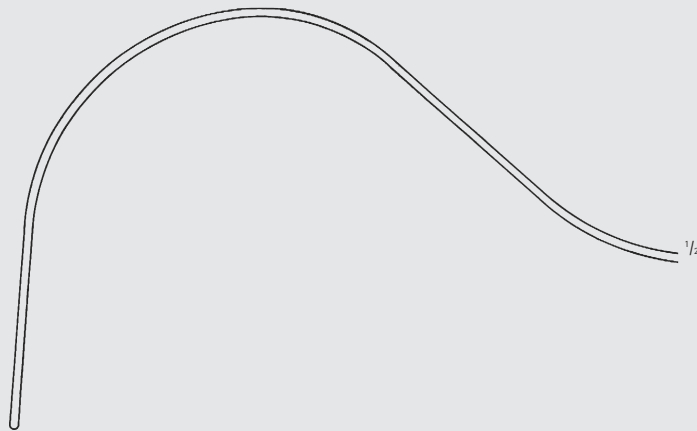

INCHES

General Surgery

Abdominal Retractors



MD076-MD072R

HASSON "S" Retractor

Catalog Number	Blade	Blade Size (mm)	Length (in.)
MD076	MALLEABLE	10	7 1/8
MD077	MALLEABLE	13	7 1/8
MD071R	RIGID	10	7 1/8
MD072R	RIGID	13	7 1/8

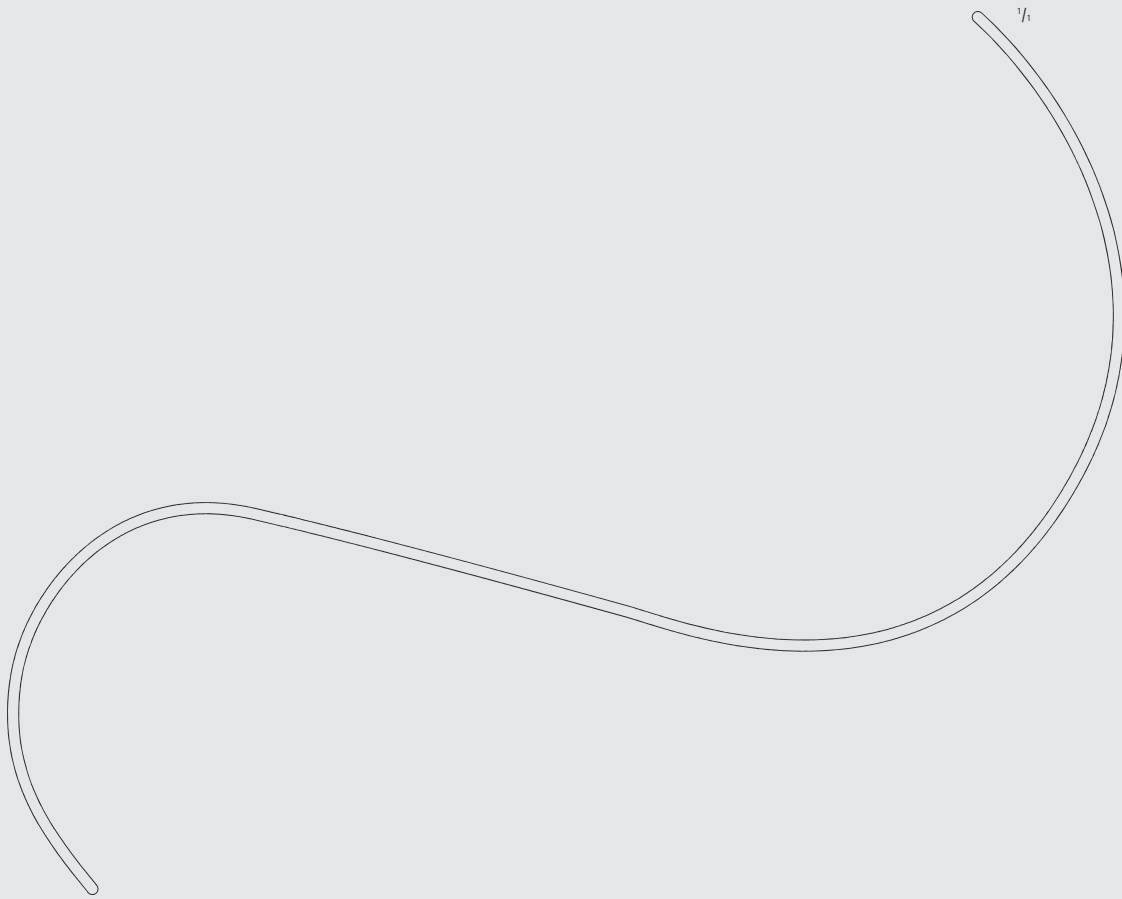



TUFFIER Spatula, Malleable

Catalog Number	Blade Size (mm)	Blade Size (in.)	Length (in.)
BT750R	17 / 25	3/4 / 1	8



Spatula, Malleable

Catalog Number	Blade Size (mm)	Blade Size (in.)	Length (in.)
BT751R	12	1/2	8
BT752R	17	3/4	8
BT755R	25	1	10



HABERER Spatula, Malleable

Catalog Number	Blade Size (mm)	Blade Size (in.)	Length (in.)
BT758R	40 / 50	1 1/2 / 2	12



RIBBON Spatula, Malleable

Catalog Number	Blade Size (mm)	Blade Size (in.)	Length (in.)
BT756R	25	1	13 1/8
BT761R	30	1 1/4	13 1/8
BT762R	40	1 1/2	13 1/8
BT763R	50	2	13 1/8

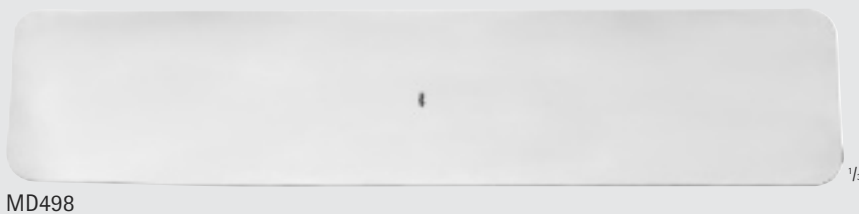

Spatula, Malleable

Catalog Number	Blade Size (mm)	Blade Size (in.)	Length (in.)
MD498	75	3	13



General Surgery

Abdominal Retractors

DOYEN Abdominal Retractor

Catalog Number	Blade Size (mm)	Length (in.)
BT667R	53 x 80	10
BT669R	72 x 82	10 1/4



BT667R



BT669R

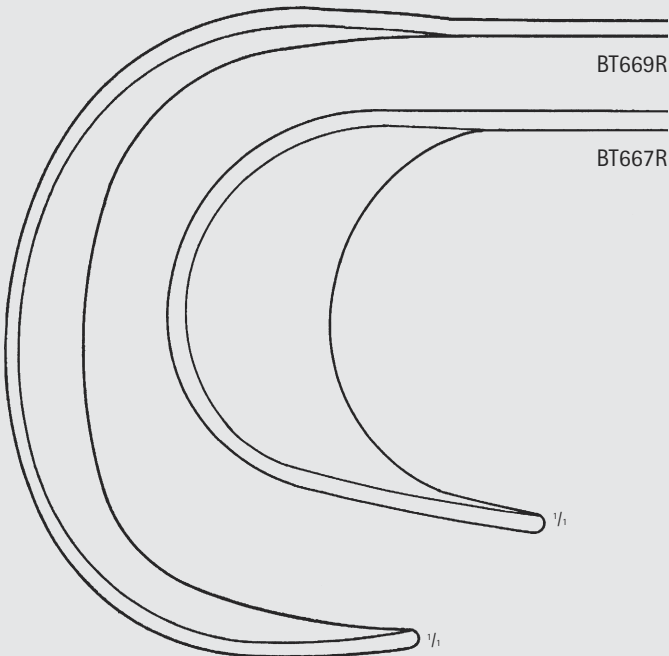

ST. MARKS Pelvis Retractor

Catalog Number	Blade Size (mm)	Length (in.)
BT670R	124 x 60	11 1/2
BT672R	174 x 60	13 1/8

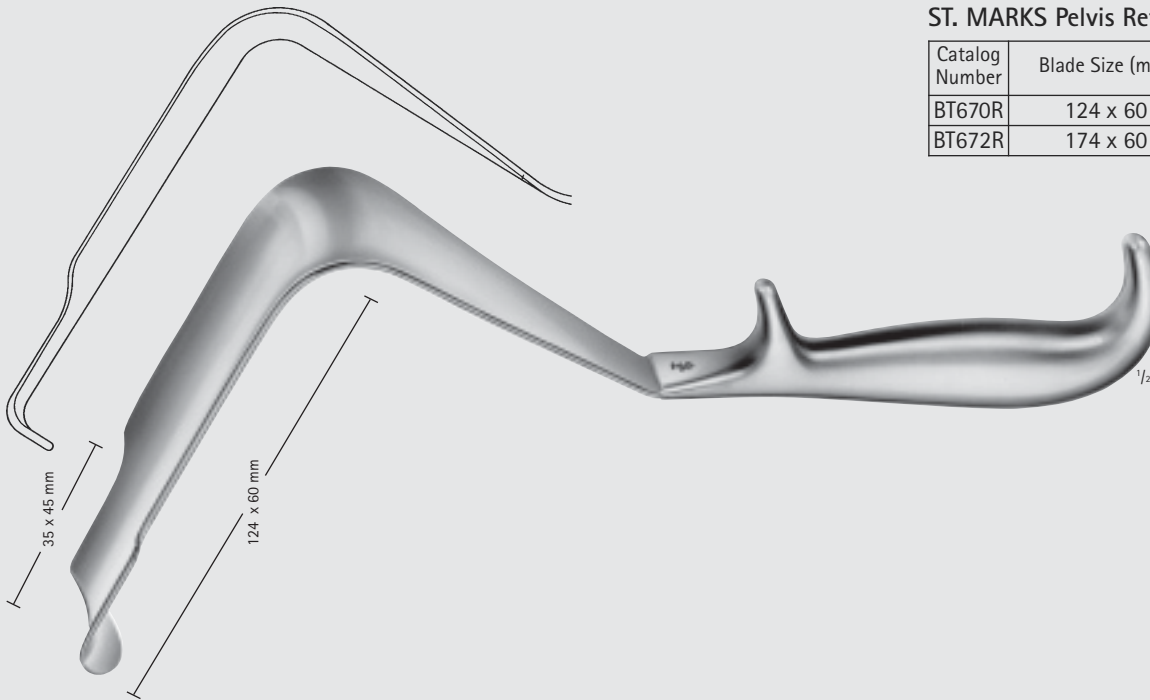

BT670R

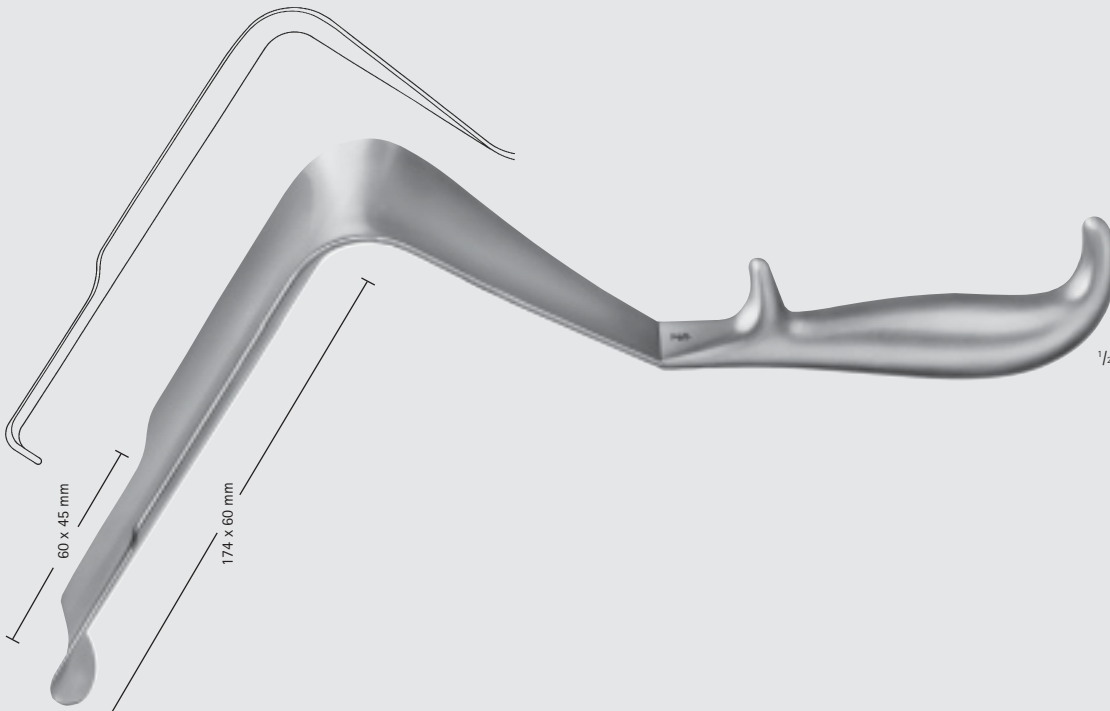

BT672R



General Surgery
Abdominal Retractors

ST. MARKS Pelvis Retractor
(continued)

Catalog Number	Blade Size (mm)	Length (in.)
BT674R	178 x 60	13 1/8

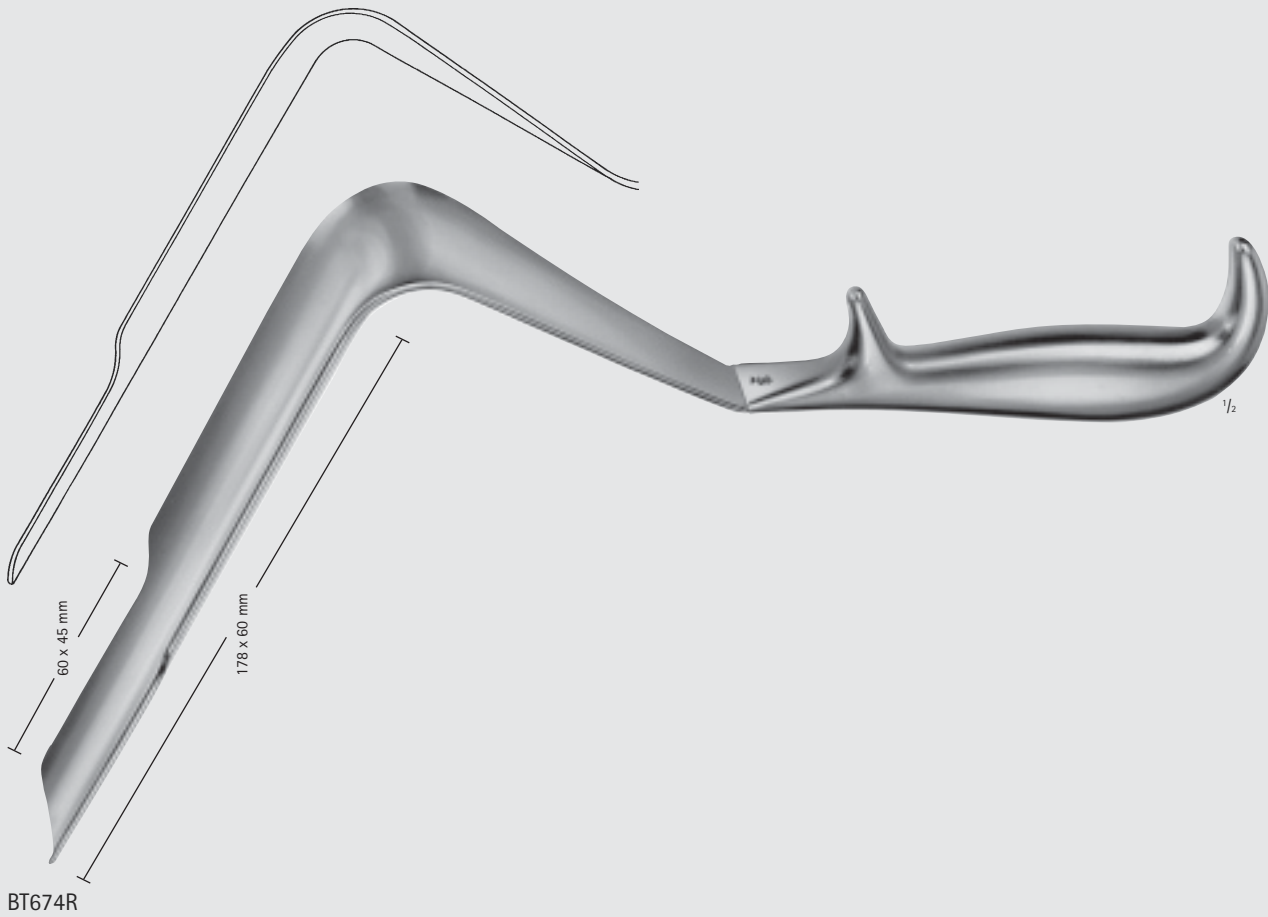

MUELLER Retractor

Catalog Number	Blade Size (mm)	Length (in.)
BT626R	250 x 30	10 3/4

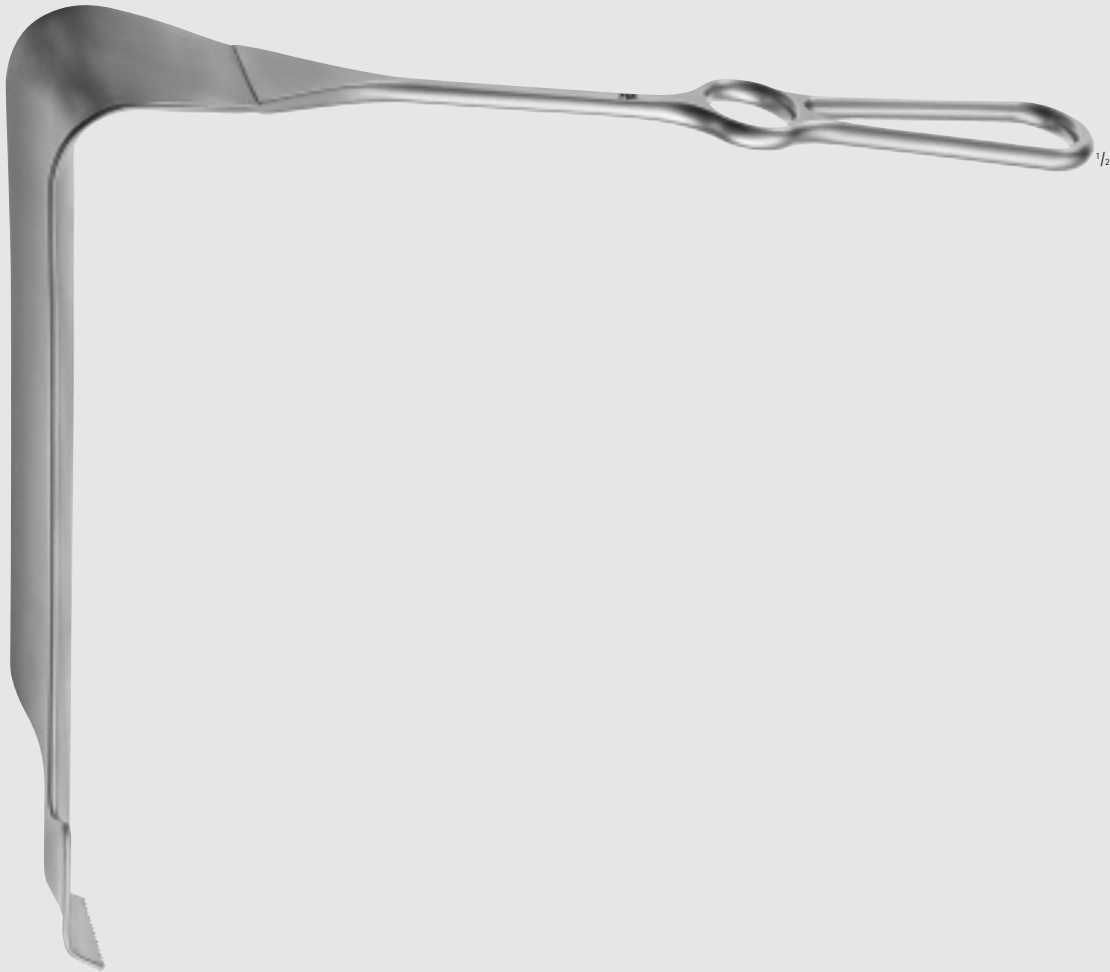

BT626R

MAYO-COLLINS Appendectomy Retractor

Catalog Number	Length (in.)
MB129R	6 3/4

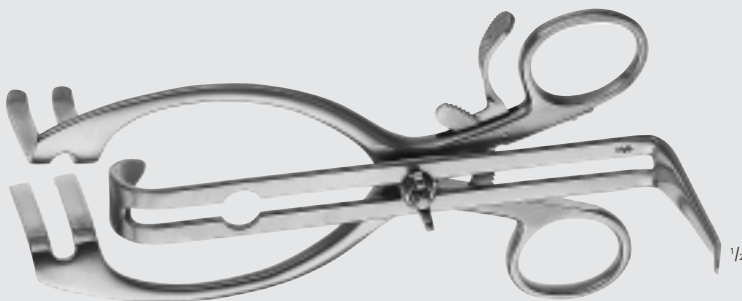

MB129R



General Surgery
Abdominal Retractors

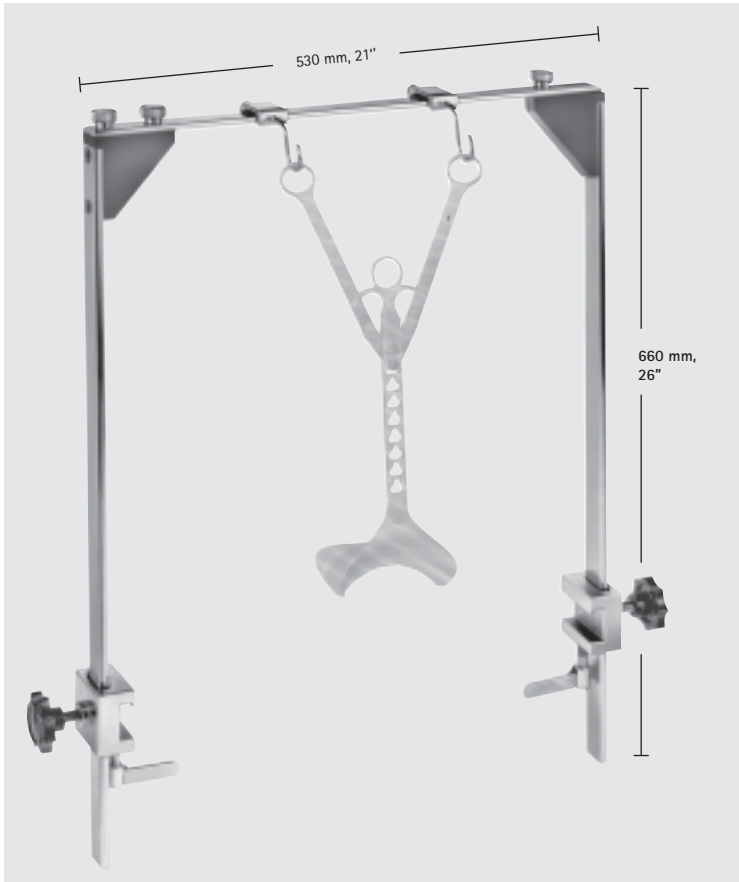

ROCHARD Retractor Mounting Frame,
F/BT71R-BT715R, Double

Catalog Number
BT708R

Mounting frame for fastening to the lateral bars of the operating tables, can be dismantled for decontamination and sterilization.

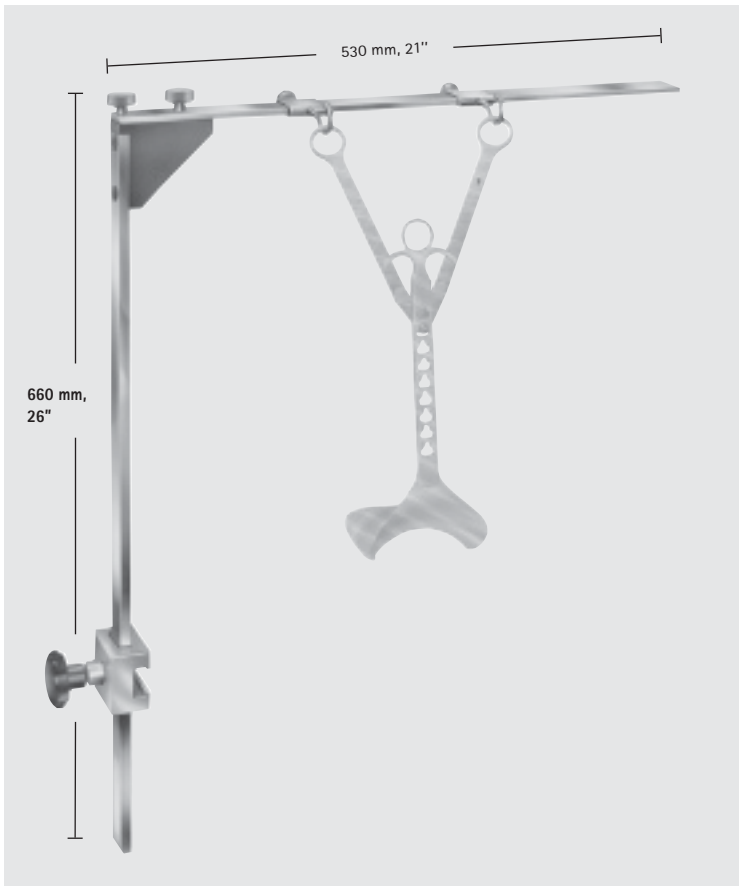

ROCHARD Retractor Mounting Frame,
F/BT710R-BT715R, Single

Catalog Number
BT709R

Mounting frame for fastening to the lateral bars of the operating tables, can be dismantled for decontamination and sterilization.

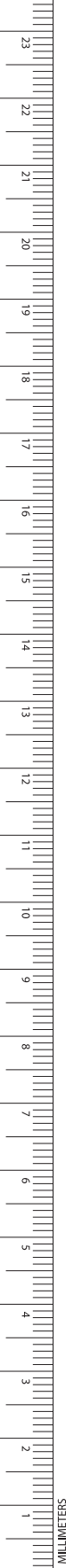

ROCHARD Fixation Device,
F/BT711R–BT715R

Catalog Number
BT710R

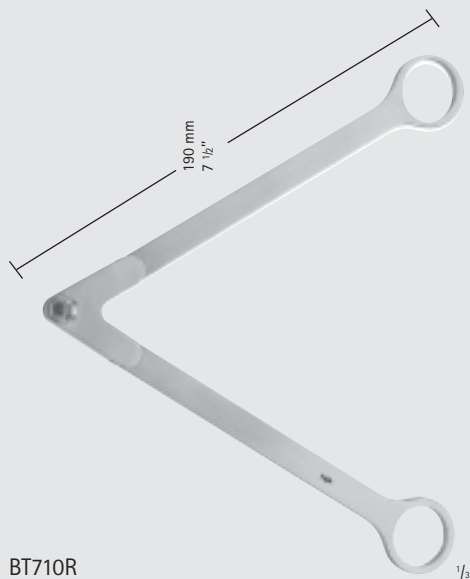

BT710R

ROCHARD Blades

Catalog Number	Blade Size (mm)	Length (in.)
BT711R	48 x 90	12 1/4
BT712R	48 x 105	12 1/4
BT713R	48 x 120	12 1/4
BT714R	48 x 135	12 1/4
BT715R	48 x 155	12 1/4

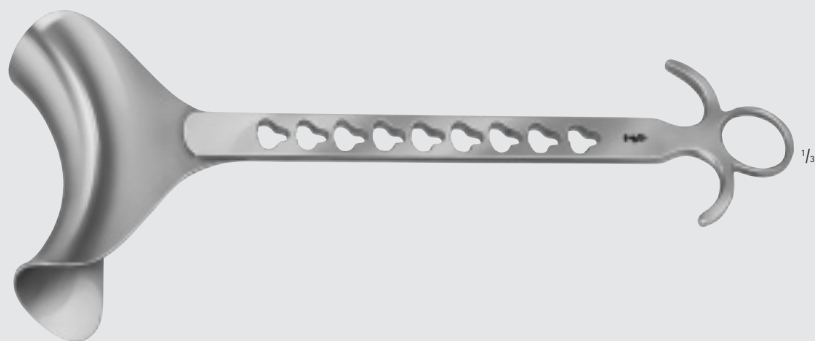

BT711R–BT715R

General Surgery

Abdominal Retractors

Abdominal Retractor, Malleable

Catalog Number	Blade Size (mm)	Blade Size (in.)	Length (in.)
BT773R	30	1 1/4	16
BT774R	40	1 1/2	16
BT775R	50	2	16
BT776R	60	2 1/2	16
BT777R	70	2 3/4	16

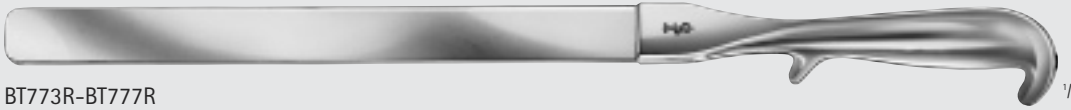

BT773R-BT777R

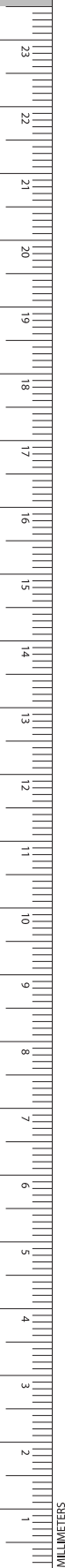
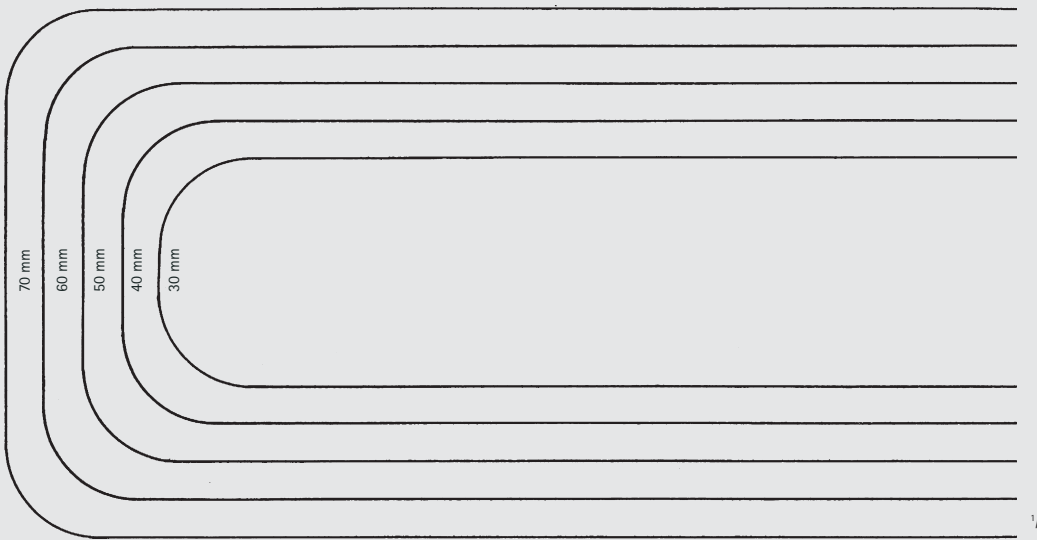

Laparotomy Ring

Catalog Number	Diameter (in.)
MB226	2



MB226

2

HERTZLER Abdominal Retractor

Catalog Number	Blade Size (mm)
BV512R	20 x 25

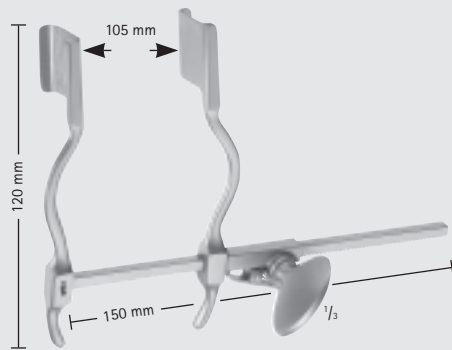

BV512R

105 mm

120 mm

150 mm

1/3

General Surgery

Abdominal Retractors

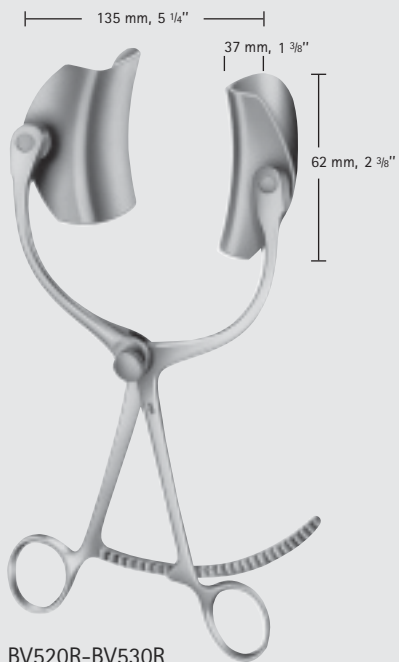

BV520R-BV530R



BV551R

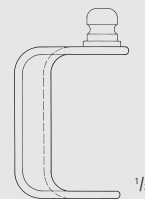

BV551R

COLLIN Abdominal Retractor W/ Ball Snap Closure

Catalog Number	Item
BV520R	SPREADER ONLY
BV530R	SET COMPLETE
BV551R	LATERAL BLADES, 37 x 62 MM



BV399R

Blade Ejector

Catalog Number	Item	Length (in.)
BV399R	FOR CHANGING BLADES WITH BALL SNAP CLOSURE	4 1/2

GOSSET Abdominal Retractor, Small

Catalog Number	Blade Size (mm)
BV500R	38

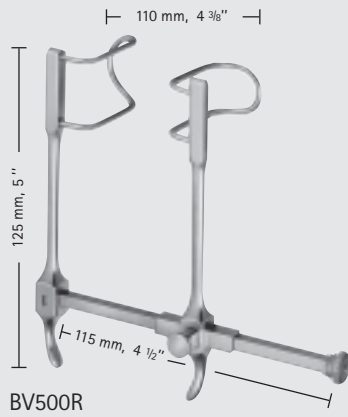

GOSSET Abdominal Retractor, Medium

Catalog Number	Blade Size (mm)
BV502R	55

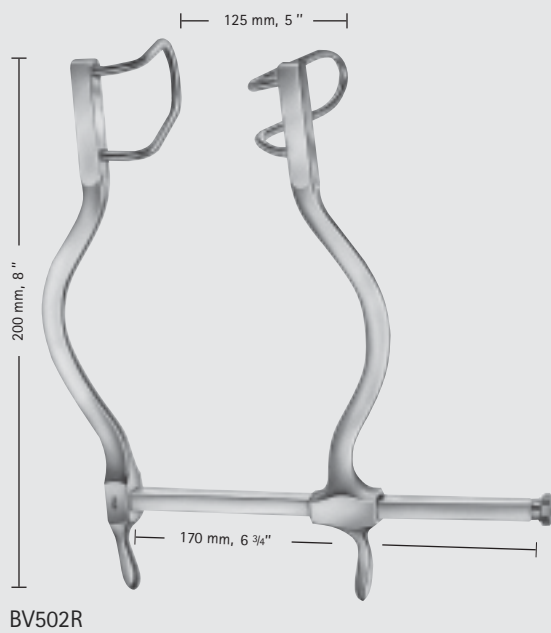

General Surgery

Abdominal Retractors

GENL

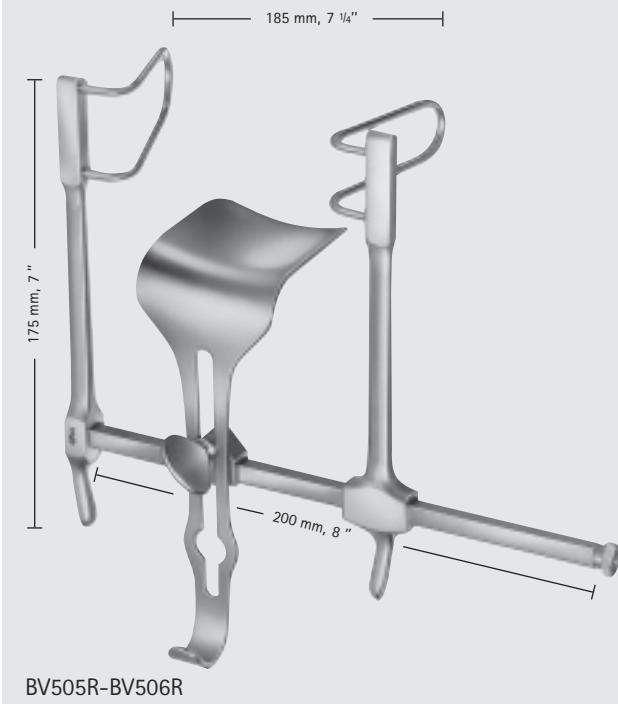
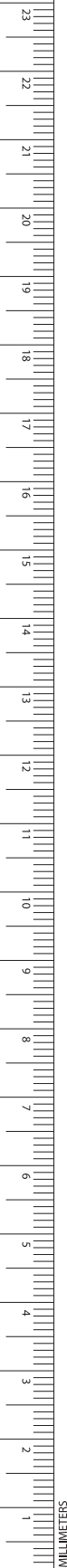

BV505R-BV506R

GOSSET Abdominal Retractor, Large

Catalog Number	Item
BV505R	SET COMPLETE
BV506R	CENTER BLADE ONLY 59 x 57 MM

BV505R Includes:
1 Center Blade BV506R

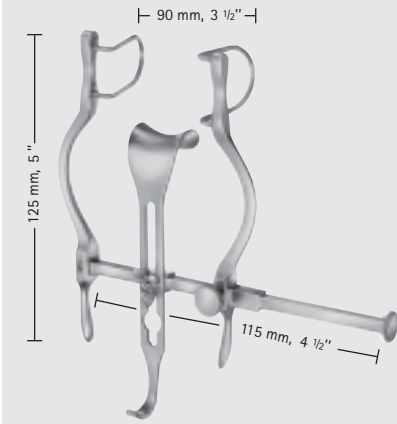

BV601R-BV602R

BALFOUR-BABY Abdominal Retractor

Catalog Number	Item
BV601R	SET COMPLETE
BV602R	CENTER BLADE ONLY, 21 x 24 MM

BV601R Includes:
1 Center Blade BV602R

BALFOUR Abdominal Retractor

Catalog Number	Item
BV605R	BALFOUR RETRACTOR, 155 x 200MM
BV606R	CENTER BLADE, 47 x 80 MM
BV609R	CENTER BLADE, 62 x 76 MM
BV611R	CENTER BLADE, 80 x 80 MM
BV608R	BALFOUR RETRACTOR, 200 x 235MM
BV610R	BALFOUR RETRACTOR, 200 x 265MM

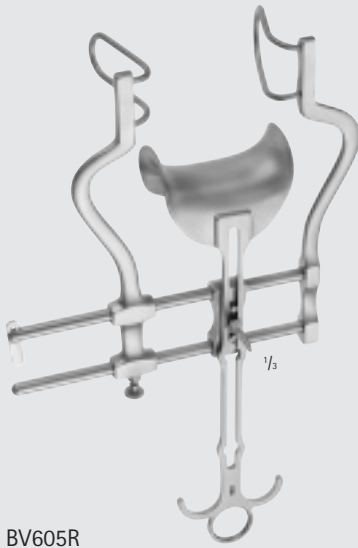

BV605R

BV608R 235 mm, 9 1/4"
BV610R 265 mm, 10 1/2"

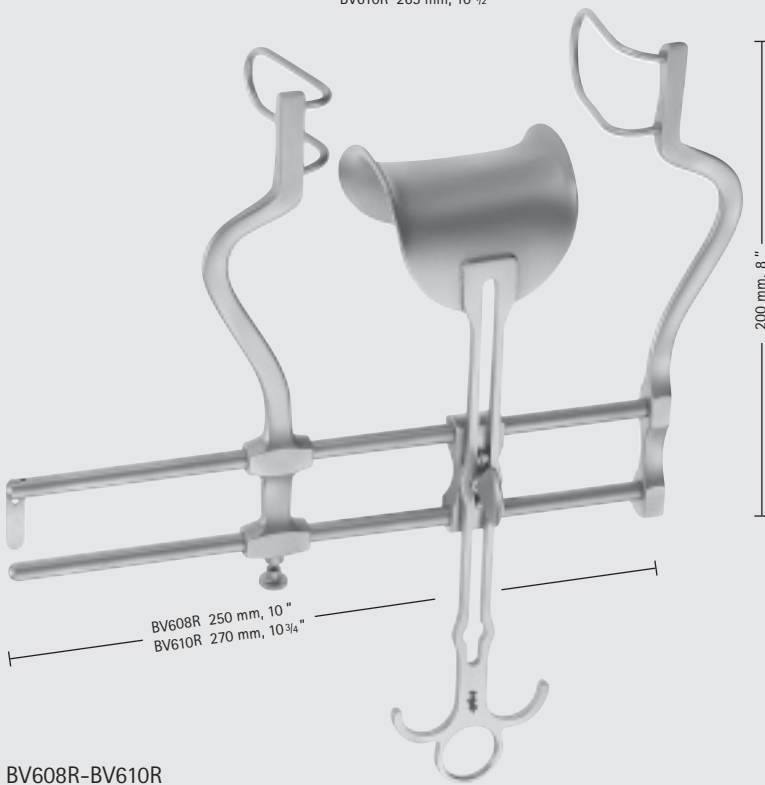

BV608R-BV610R



INCHES

General Surgery

Abdominal Retractors

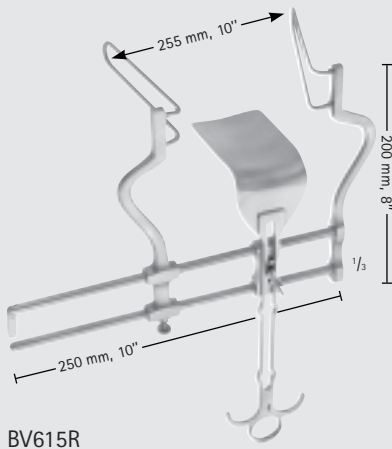

BV615R

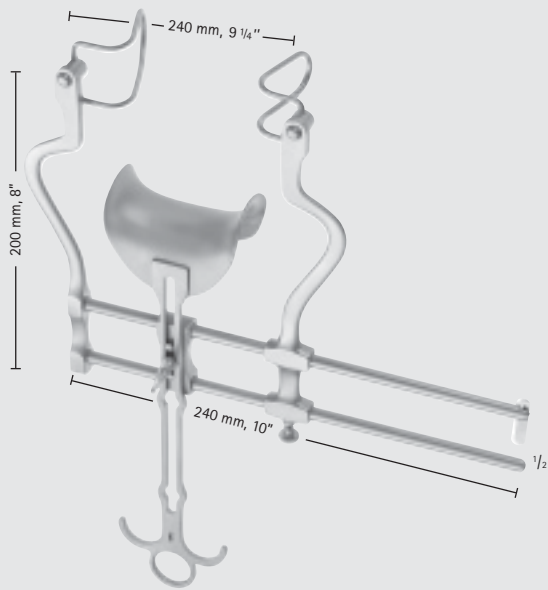

BV632R-BV638R



BALFOUR Abdominal Retractor (continued)

Catalog Number	Item
BV615R	BALFOUR RETRACTOR, 200 x 255MM
BV616R	CENTER BLADE, 107 x 59MM
BV621R	SPREADER ONLY, 200 x 250MM
BV622R	LATERAL BLADE, PAIR, 50MM
BV624R	LATERAL BLADE, PAIR 60MM
BV626R	LATERAL BLADE, PAIR 75MM
BV628R	LATERAL BLADE, PAIR 90MM
BV632R	BALFOUR RETRACTOR, COMPLETE W/BV606R, BV622R
BV634R	BALFOUR RETRACTOR, COMPLETE W/BV609R, BV624R
BV636R	BALFOUR RETRACTOR, COMPLETE W/BV611R, BV626R
BV638R	BALFOUR RETRACTOR, COMPLETE W/BV611R, BV628R

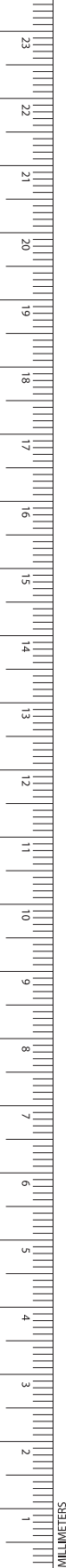

**BALFOUR Side Blades Solid
F/Retractors MB221R, MB222R**

Catalog Number	Item
MB637R	PAIR, 2 1/2" (64 MM) DEEP
MB638R	PAIR, 3 1/2" (89 MM) DEEP
MB639R	PAIR, 4" (102 MM) DEEP



**BALFOUR Side Blades Wire
F/Retractors MB211R, MB222R**

Catalog Number	Item
MB577R	PAIR, 2 1/2" (64 MM) DEEP
MB578R	PAIR, 3 1/2" (89 MM) DEEP
MB579R	PAIR, 4" (102 MM) DEEP

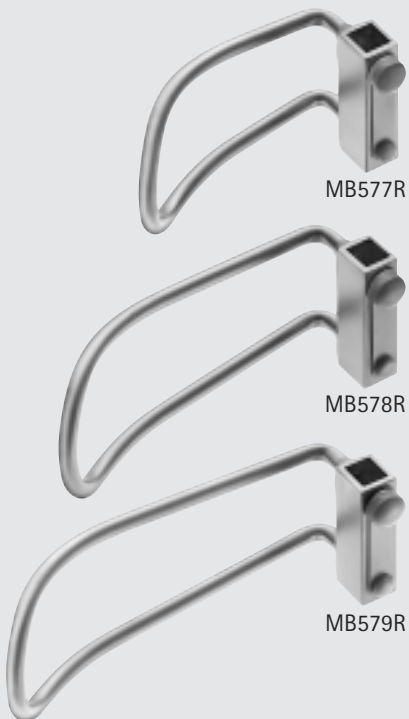

General Surgery
Abdominal Retractors

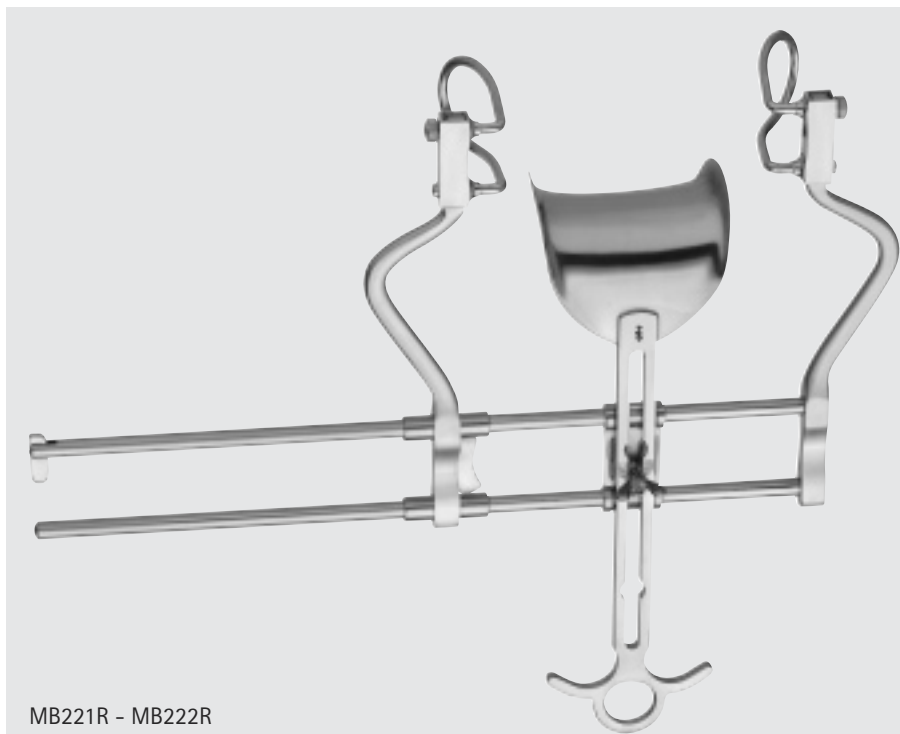

MB221R - MB222R

BALFOUR Retractor W/Exchangeable Lateral Blades

Catalog Number	Overall Width (in.)	OP-Opening (in.)	Item
MB221R	16	10 1/2	2 PAIRS OF DETACHABLE BLADES 2 1/2" AND 3 1/2", 1 CENTER BLADE 2 3/4 X 3 1/4"
MB222R	16	8 1/2	2 PAIRS OF DETACHABLE BLADES 2 1/2" AND 3 1/2", 1 CENTER BLADE 2 1/2" X 2 1/2"



MB225

BALFOUR Retractor

Catalog Number	Overall Width (in.)	OP-Opening (in.)	Item
MB225	13	11	2 LATERAL BLADES 2" X 2" AND 1 1/4" X 2", 1 CENTER BLADE 3" X 10 1/2"

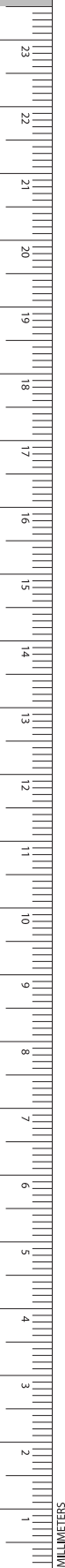



MB573R-MB574R

DIXON Center Blades

Catalog Number	Blade	Blade Size (mm)
MB573R	MALLEABLE	171 x 51
MB574R	MALLEABLE	267 x 57



BV617R

**BALFOUR Center Blade For All
BALFOUR Retractors**

Catalog Number	Blade Size (mm)
BV617R	54 x 80



BV618R

Center Blade F/BV615R

Catalog Number	Blade Size (mm)
BV618R	75 x 80



INCHES

General Surgery

Abdominal Retractors

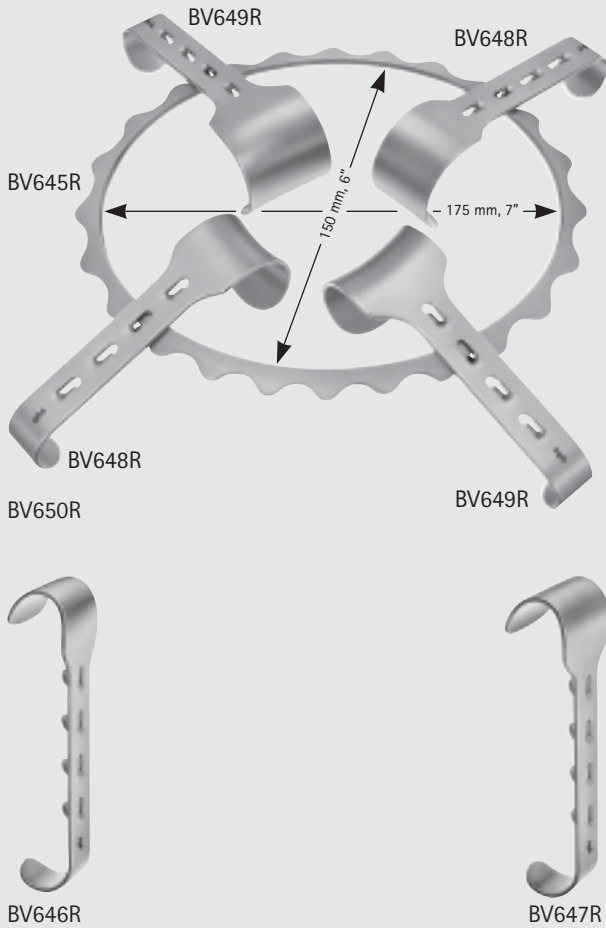

DENIS-BROWNE Abdominal Retractor

Catalog Number	Item
BV650R	COMPLETE SET
BV645R	FRAME ONLY, 175 x 150MM
BV648R	2 BLADES ONLY, 40 x 30MM
BV649R	2 BLADES ONLY, 40 x 40MM
BV646R	BLADE ONLY, 20 x 30MM
BV647R	BLADE ONLY, 20 x 40MM

BV650R Includes:

1 Frame BV645R

2 Blades of each BV648R and BV649R

SEMM Abdominal Retractor

Catalog Number	Item	Blade Size (mm)
BV654R	COMPLETE SET	
BV653R	FRAME	
BV655R	2 BLADES	46 x 64
BV656R	BLADE	53 x 54
BV657R	BLADE	82 x 97
BV658R	BLADE	98 x 51
BV659R	BLADE	107 x 36

BV654R Includes:

- 1 Frame BV653R
- 1 Blade of each BV656R, BV657R, BV658R and BV659R
- 2 Blades BV655R

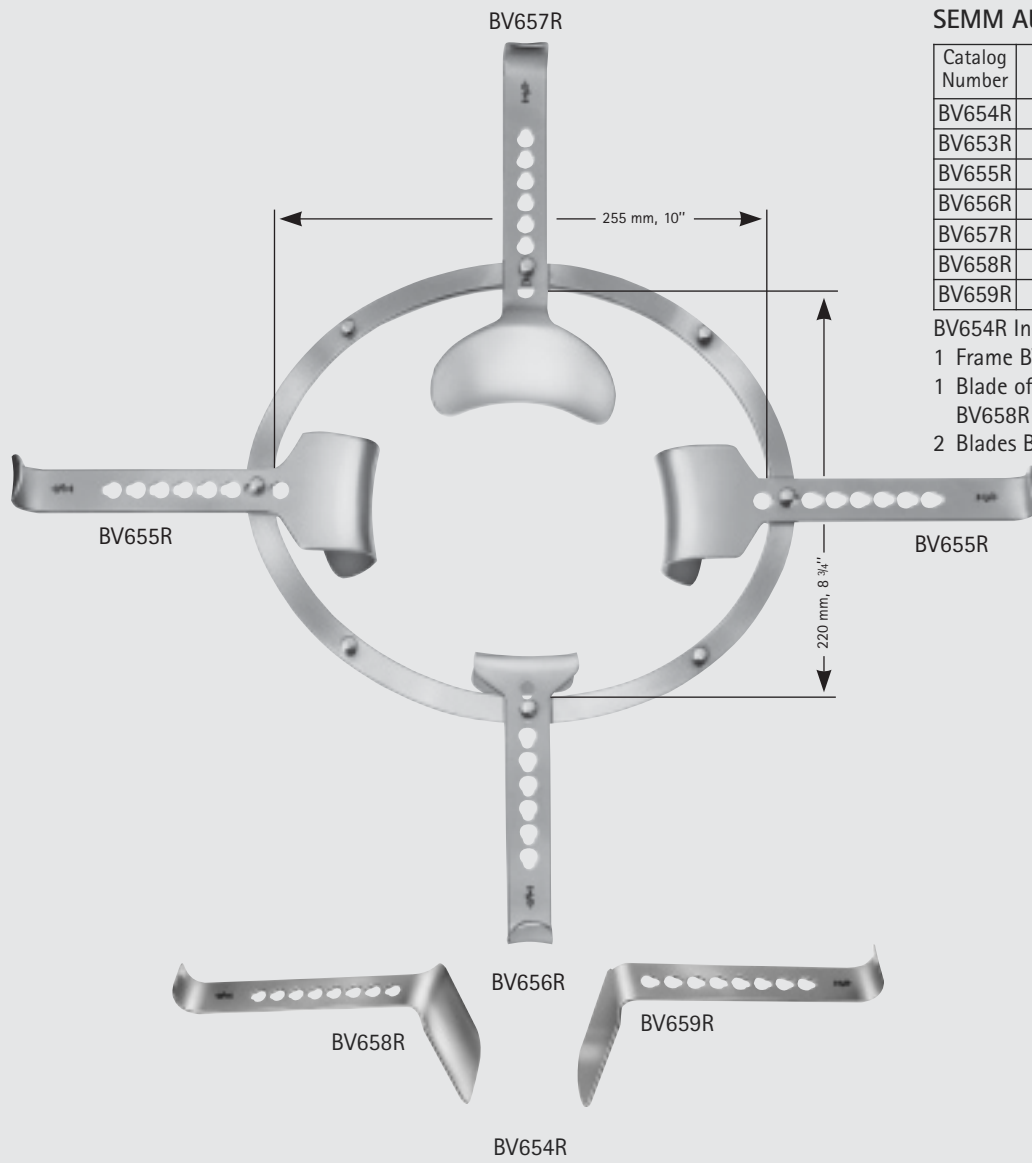

General Surgery

Universal Ring Retractor System

■ For more information see in our brochure number DOC380



MB499R

Universal Ring Retractor System

Catalog Number	Item
MB499R	COMPLETE SET

Complete System Includes:

- MB497 Segmented Medium Oval Ring
- MB516 Medium Oval Ring
- MB506 Standard Table Clamp 18"
- MB488R Horizontal Flex Bar w/ 360° Rotation 19 1/4"
- MB487R Horizontal Fixed Bar 15 1/2"
- MB504 Post Clamp for 1" Bar
- MB503 Non-Tilting Blade Clamp (2 each)
- MB510 Tilting Blade Clamp (6 each)
- MB524 KELLY Retractor Blade 2" x 3" (2 each)
- MB525 KELLY Retractor Blade 2" x 4"
- MB526 KELLY Retractor Blade 2" x 5"
- MB527 KELLY Retractor Blade 2" x 6"
- MB529 Malleable Retractor Blade 1 1/2" x 6"
- MB530 Malleable Retractor Blade 2" x 6"
- MB532 Malleable Retractor Blade 3" x 6"
- MB534 BALFOUR Bladder Blade 3" x 2 1/2"
- MB544 HARRINGTON Sweetheart Blade 2 1/2" x 5"
- MB546 GELPI Point Retractor Blade

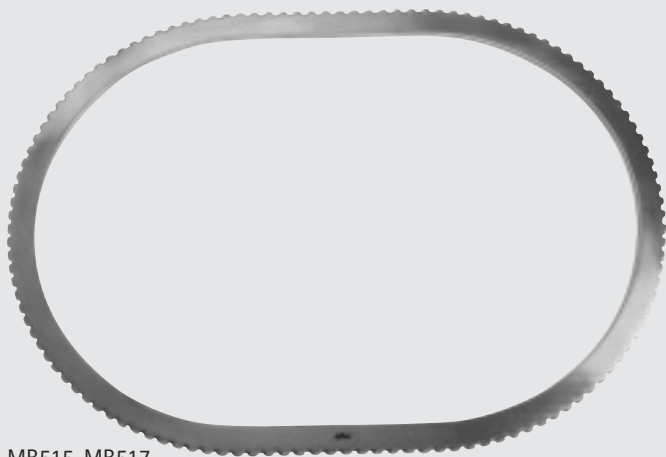

MB515-MB517

Oval Rings

Catalog Number	Size	Width x Length (in.)
MB515	SMALL	8 1/2 x 12
MB516	MEDIUM	10 1/2 x 15
MB517	LARGE	12 1/2 x 18 1/2



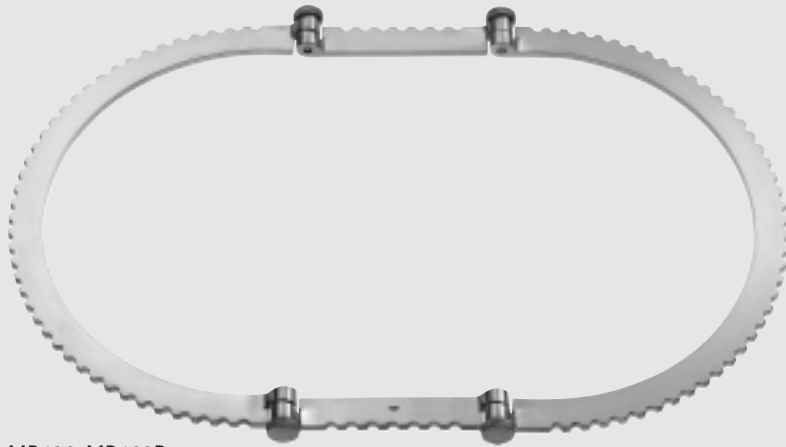

MB496-MB462R

Segmented Oval Rings

Catalog Number	Size	Description	Width x Length (in.)
MB496	SMALL	INCLUDES REMOVABLE 4" SEGMENTS	8 1/2 x 14
MB497	MEDIUM	INCLUDES REMOVABLE 8" SEGMENTS	10 1/2 x 19 1/2
MB498	LARGE	INCLUDES REMOVABLE 6" SEGMENTS	12 1/2 x 19 1/2
MB462R	X-LARGE	INCLUDES REMOVABLE 6" SEGMENTS	16 X 22



MB471R-MB473R

Segments for Segmented Oval Rings, Pair

Catalog Number	Length (in.)
MB471R	4
MB472R	6
MB473R	8

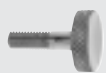

MB564

Segmented Ring Screw

Catalog Number
MB564



INCHES

General Surgery

Universal Ring Retractor System

GENL

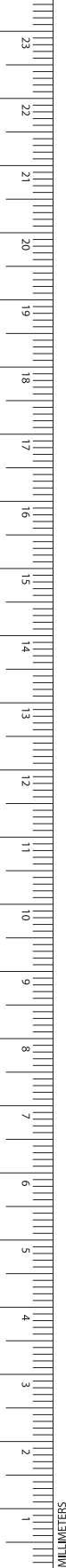

MB489

Vaginal Ring

Catalog Number	Description	Width x Length (in.)
MB489	20° ANGLE	8 x 10 1/2



MB519-MB522

Round Rings

Catalog Number	Size	Diameter (in.)
MB519	SET	
MB520	SMALL	8 1/2
MB521	MEDIUM	10 1/2
MB522	LARGE	12 1/2

MB519 Includes:
1 each MB520-MB522



MB503

Non-Tilting Blade Clamp

Catalog Number
MB503

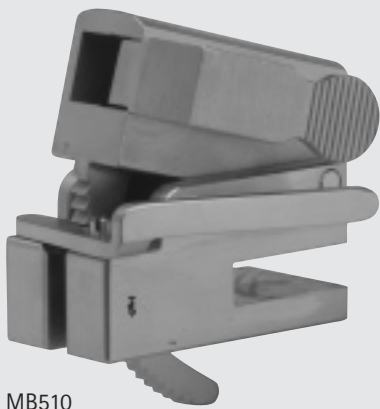

MB510

Tilting Blade Clamp

Catalog Number
MB510

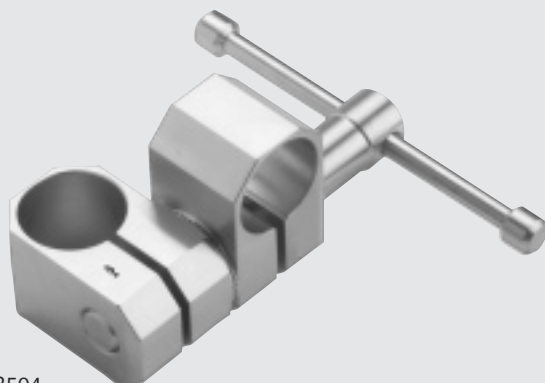

MB504

Post Clamp

Catalog Number
MB504



General Surgery

Universal Ring Retractor System

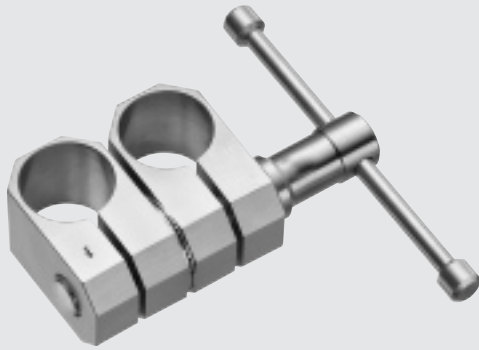

MB505

Vertical Extension Bar Clamp

Catalog Number
MB505

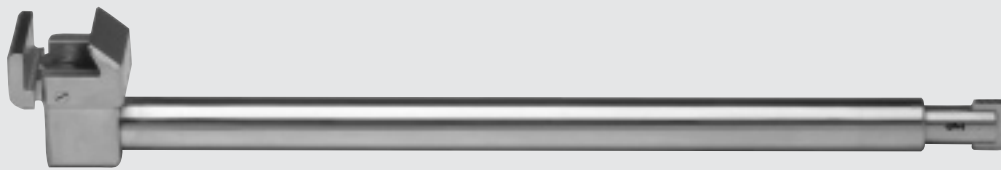

MB506

Table Clamp

Catalog Number	Working Length (in.)	Overall Length (in.)
MB506	15	18
MB460R	21	24



MB487R-MB823R

Horizontal Fixed Bar

Catalog Number	Length (in.)
MB487R	15 1/2
MB823R	22

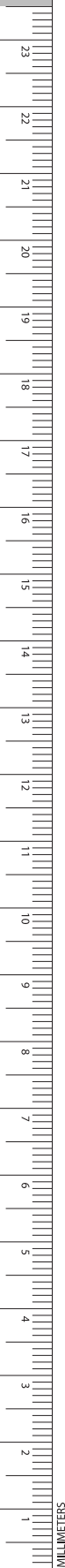

Horizontal Flex Bar W/360° Rotation

Catalog Number	Length (in.)
MB488R	19
MB824R	22 1/2



MB488R-MB824R

Vertical Extension Bar

Catalog Number	Length (in.)
MB508	12
MB822R	14



MB508-MB822R

Adapter For Attaching
 Handheld Retractors

Catalog Number
MB509



MB509



INCHES

General Surgery

Universal Ring Retractor System

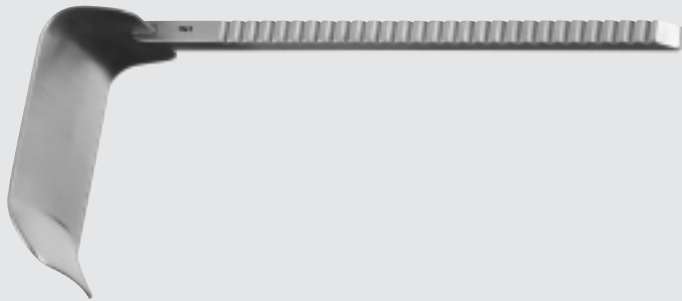

MB555-MB469R

KELLY Retractor Blades

Catalog Number	Description	Width/Depth (in.)
MB555		1 x 1 1/2
MB556		1 x 2 1/2
MB936R		2 x 1 1/2
MB937R		2 x 2 1/2
MB524		2 x 3
MB525		2 x 4
MB526		2 x 5
MB527		2 x 6
MB469R	BARIATRIC	2 x 8



MB860R-MB467R

Malleable Retractor Blades

Catalog Number	Description	Width/Depth (in.)
MB860R		3/4 x 2
MB861R		3/4 x 3
MB862R		1 x 1
MB863R		1 x 4
MB864R		1 x 5
MB865R		1 1/2 x 3
MB866R		1 1/2 x 4
MB529		1 1/2 x 6
MB867R		1 1/2 x 8
MB530		2 x 6 1/2
MB531		2 x 8
MB463R	BARIATRIC	2 x 10
MB532		3 x 6
MB464R	BARIATRIC	3 x 10
MB466R	BARIATRIC	3 x 12
MB869R	BARIATRIC	4 x 8
MB465R	BARIATRIC	4 x 10
MB467R	BARIATRIC	4 x 12



MB557-MB559

RICHARDSON Retractor

Catalog Number	Width/Depth (in.)
MB557	3/4 x 1
MB558	3/4 x 2
MB559	1 x 1 1/4





MB534-MB470R

BALFOUR Bladder Blades

Catalog Number	Description	Width/Depth (in.)
MB534		3 x 2 1/2
MB535		3 x 3 1/4
MB470R	BARIATRIC	3 x 3 1/2



MB537-MB539

DEAVER Retractor Blades

Catalog Number	Width/Depth (in.)
MB537	1 x 4 1/2
MB538	1 1/2 x 4 1/2
MB539	2 x 4 1/2



MB492-MB493

DEAVER Vaginal Retractor Blades

Catalog Number	Description	Width/Depth (in.)
MB492	SMALL	1 x 3 1/2
MB493	LARGE	1 x 5



INCHES

General Surgery

Universal Ring Retractor System

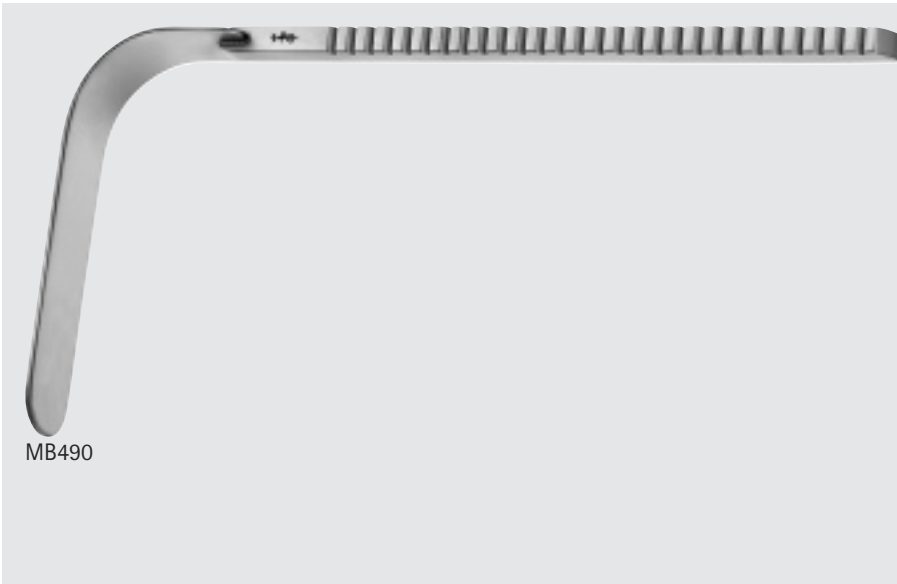
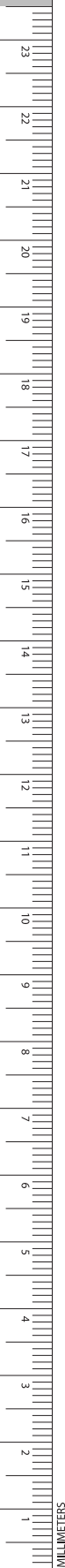

MB490

Vaginal Retractor Posterior Blade

Catalog Number	Width/Depth (in.)
MB490	1 x 4 1/2



MB491

Vaginal Retractor Lateral Blade

Catalog Number	Width/Depth (in.)
MB491	1 x 3



MB494-MB495

Rectal Blades

Catalog Number	Description	Width/Depth (in.)
MB494	SMALL	7/8 x 2 7/8
MB495	LARGE	7/8 x 3 7/8

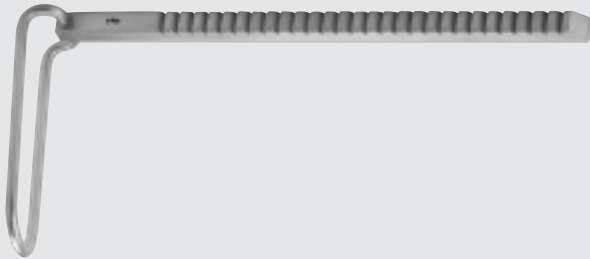

MB541

Skin Incision Blade

Catalog Number	Width/Depth (in.)
MB541	1 1/8 x 3 1/4



MB543-MB832R

HARRINGTON Sweetheart Blades

Catalog Number	Description	Width/Depth (in.)
MB543		1 1/2 x 5
MB544		2 1/2 x 5 5/8
MB468R	BARIATRIC	3 1/2 x 10
MB832R	BARIATRIC	4 1/2 x 10



MB546

GELPI Point Retractor Blade

Catalog Number	MB546
----------------	-------



INCHES

General Surgery

Universal Ring Retractor System

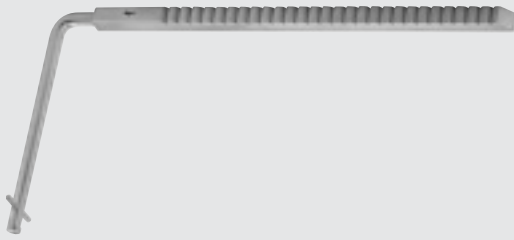

MB548-MB549

SCOVILLE Hook Retractor Blades

Catalog Number	Description	Depth (in.)
MB548	LARGE	3 1/4
MB549	SMALL	2

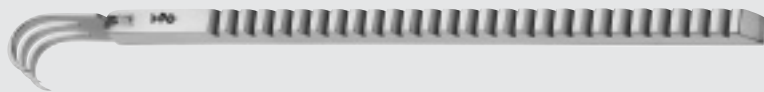

MB566-MB568

Rake Retractors

Catalog Number	Description	Width/Depth (in.)
MB566	3 PRONGS	2/3 x 3/4
MB567	4 PRONGS	3/4 x 1/3
MB568	6 PRONGS	1 x 1/3



MB551-MB553

MEYERDING Retractor Blades

Catalog Number	Width/Depth (in.)
MB551	1 x 3 1/3
MB552	2 x 3 3/4
MB553	2/3 x 2 1/3

General Surgery

Self Retaining Retractors

GENL



BV001R



FINSEN Retractor

Catalog Number	Length (in.)
BV001R	2

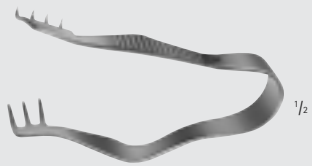

BV002R



FINSEN Retractor

Catalog Number	Length (in.)
BV002R	2 3/4

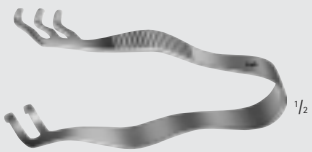

BV003R



FINSEN Retractor

Catalog Number	Length (in.)
BV003R	3



BV005R



FINSEN Retractor

Catalog Number	Length (in.)
BV005R	2 3/4



BV014R

PARSONNET Epicardial Retractor

Catalog Number	Blade End	Length (in.)
BV014R	3 x 3 PRONGS	2



INCHES

General Surgery

Self Retaining Retractors

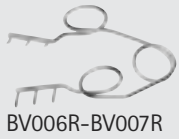

BV006R-BV007R



BV006R



BV007R



MD471

Spring Wire Retractor

Catalog Number	Blade End	Tip	Length (in.)
BV006R	3 x 3 PRONGS	BLUNT	1 3/4
BV007R	3 x 3 PRONGS	BLUNT	2 1/8
MD471	1 x 1 PRONG	SHARP	3

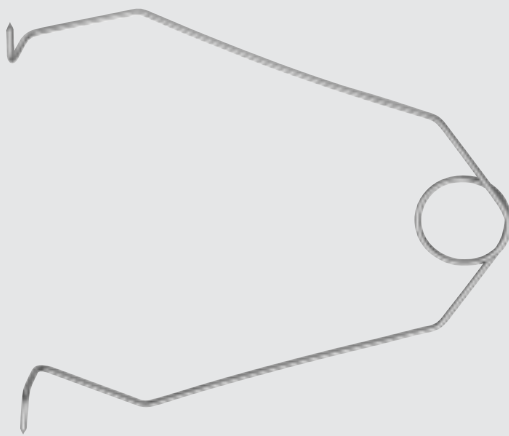

MB777R-MB778R

Spring Wire Retractor

Catalog Number	Size	Length (in.)
MB777R	1	5
MB778R	2	5 1/8



BV010R-BV011R



BV010R



BV011R

ALM Retractor

Catalog Number	Blade End	Tip	Length (in.)
BV010R	4 x 4 PRONGS	SHARP	2 3/4
BV011R	4 x 4 PRONGS	SHARP	4





BV021R-BV024R

Epicardial Retractor

Catalog Number	Blade End	Tip	Size	Length (in.)
BV021R	3 x 3 PRONGS	SHARP	MINI	1
BV022R	3 x 3 PRONGS	SHARP	SMALL	1 1/4
BV023R	3 x 3 PRONGS	SHARP	MEDIUM	1 1/2
BV024R	3 x 3 PRONGS	SHARP	LARGE	2



BV015R-BV016R

Automatic Skin Retractors

Catalog Number	Tip	Length (in.)
BV015R	SHARP	4
BV016R	BLUNT	4



INCHES

General Surgery

Self Retaining Retractors

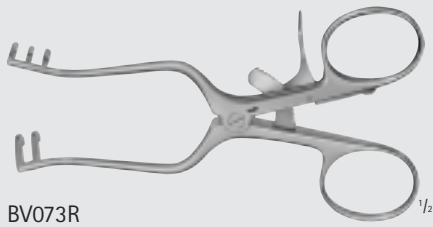

BV073R

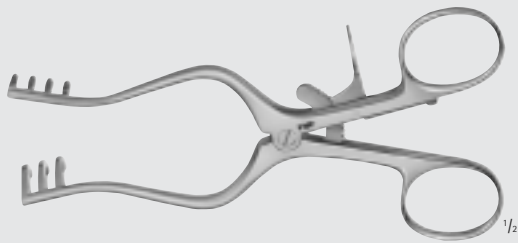

BV074R

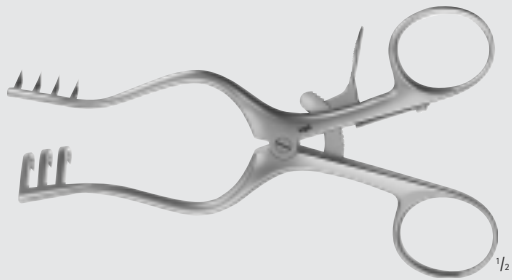
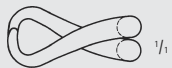

BV101R

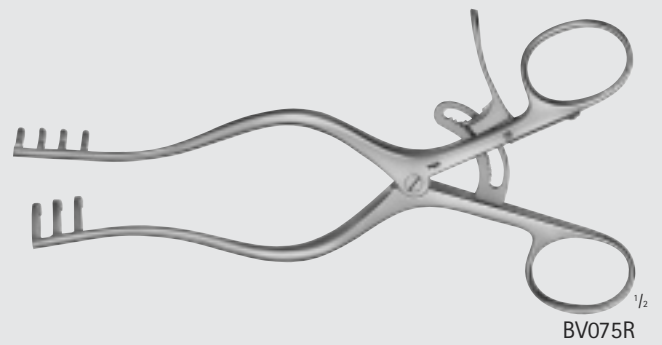

BV075R

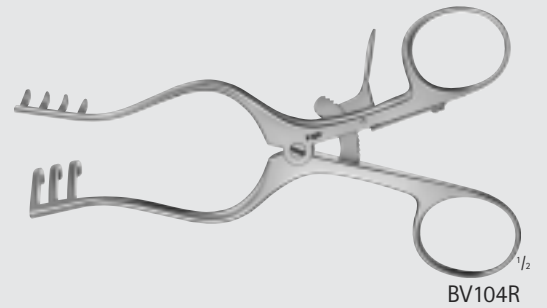
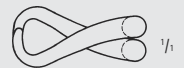

BV104R

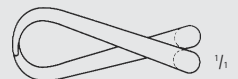

WEITLANER Retractor

Catalog Number	Blade End	Tip	Length (in.)
BV073R	2 x 3 PRONGS	BLUNT	4 3/8
BV074R	3 x 4 PRONGS	BLUNT	5 1/8
BV075R	3 x 4 PRONGS	BLUNT	6 1/2
BV101R	3 x 4 PRONGS	SHARP/DEEP	5 1/8
BV104R	3 x 4 PRONGS	BLUNT/DEEP	5 1/8

WEITLANER Retractor

Catalog Number	Blade End	Tip	Length (in.)
BV066R	2 x 3 PRONGS	SEMI-S	4 3/8
BV067R	3 x 4 PRONGS	SEMI-S	5 1/8
BV070R	2 x 3 PRONGS	SHARP	4 3/8
BV068R	3 x 4 PRONGS	SEMI-S	6 1/2
BV071R	3 x 4 PRONGS	SHARP	5 1/8
BV072R	3 x 4 PRONGS	SHARP	6 1/2

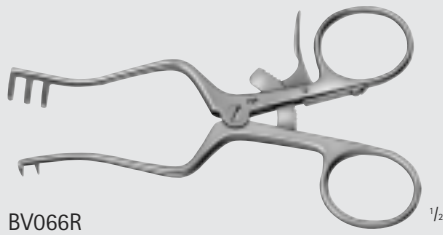

BV066R

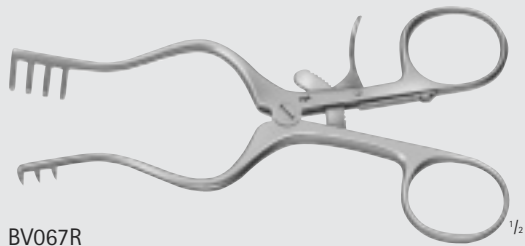

BV067R

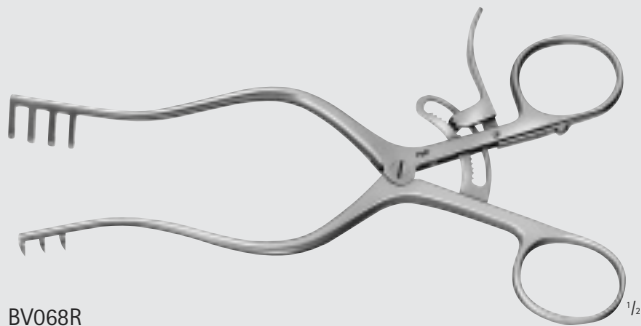
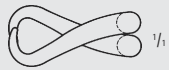

BV068R

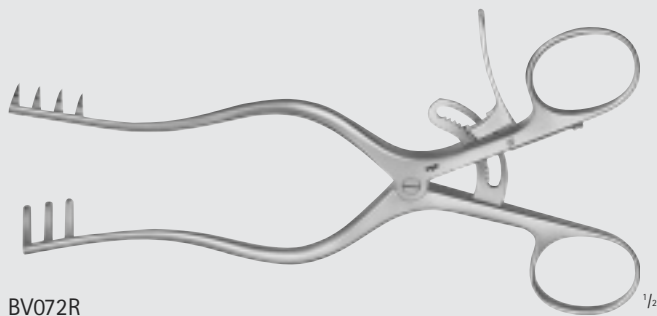
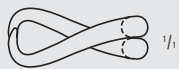

BV072R

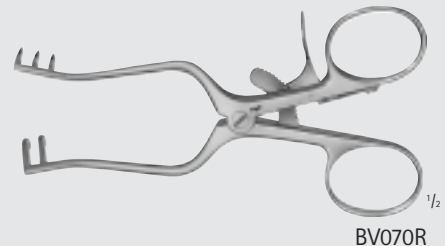
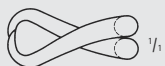

BV070R

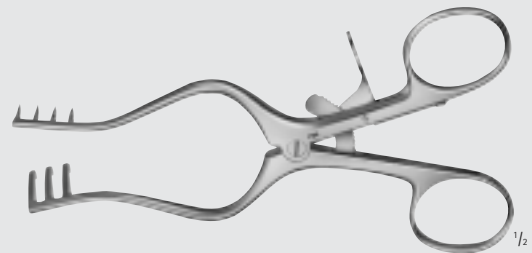

BV071R

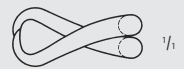

INCHES

General Surgery

Self Retaining Retractors



BV076R $\frac{1}{2}$

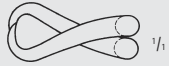

BV077R $\frac{1}{2}$

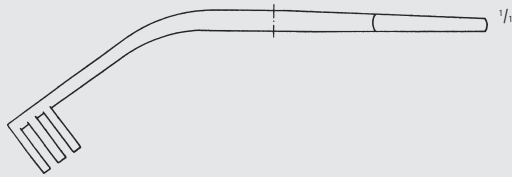
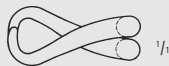

WULLSTEIN Retractor

Catalog Number	Blade End	Tip	Length (in.)
BV076R	3 x 3 PRONGS	SHARP	5 1/8
BV077R	3 x 3 PRONGS	BLUNT	5 1/8

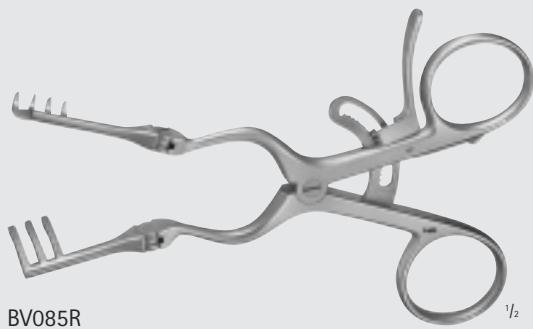

BV085R $\frac{1}{2}$

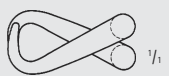

ADSON-BABY Retractor

Catalog Number	Blade End	Tip	Length (in.)
BV085R	3 x 4 PRONGS	SEMI-SHARP	5 1/2

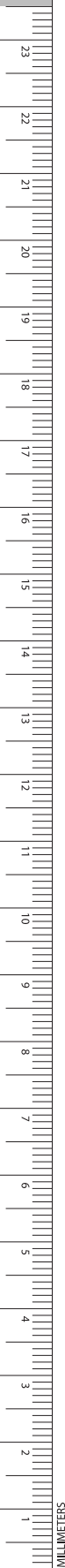

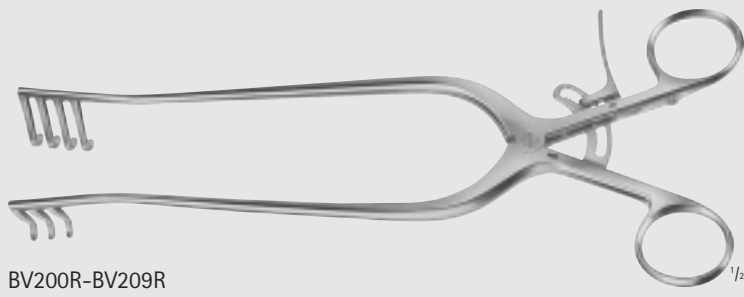

BV200R-BV209R

WEITLANER Retractor

Catalog Number	Blade End	Tip	Length (in.)
BV200R	3 x 4 PRONGS	SHARP	7 3/4
BV201R	3 x 4 PRONGS	BLUNT	7 3/4
BV206R	3 x 4 PRONGS	SHARP	9 1/2
BV207R	3 x 4 PRONGS	BLUNT	9 1/2
BV208R	5 x 6 PRONGS	SHARP	10
BV209R	5 x 6 PRONGS	BLUNT	10



BV200R



BV201R

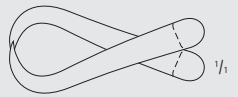
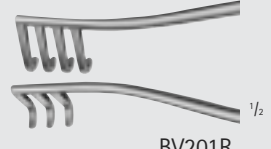

BV206R

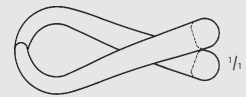

BV207R

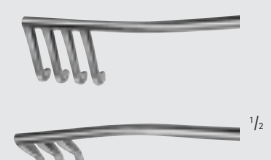

BV208R

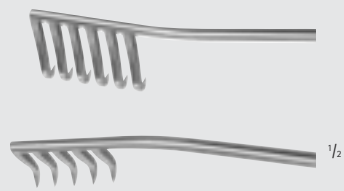

BV209R

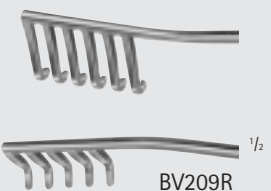

BV248R

NORFOLK Retractor

Catalog Number	Blade End	Tip	Length (in.)
BV248R	4 x 5 PRONGS	BLUNT	8 3/4

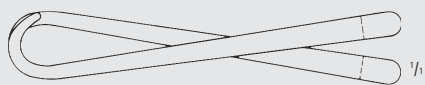

General Surgery

Self Retaining Retractors

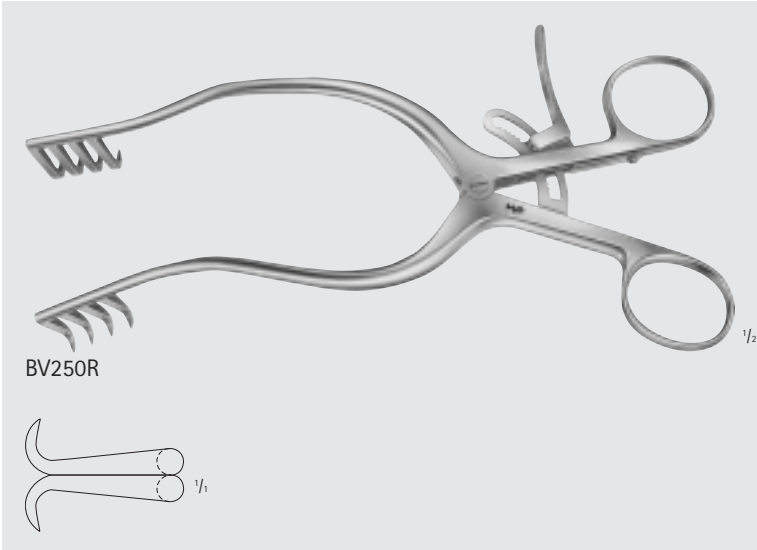
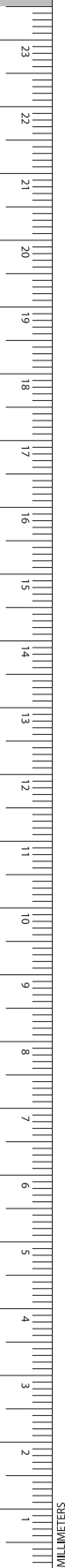

BV250R

ANDERSON-ADSON Retractor

Catalog Number	Blade End	Tip	Length (in.)
BV250R	4 x 4 PRONGS	SHARP	7 1/2

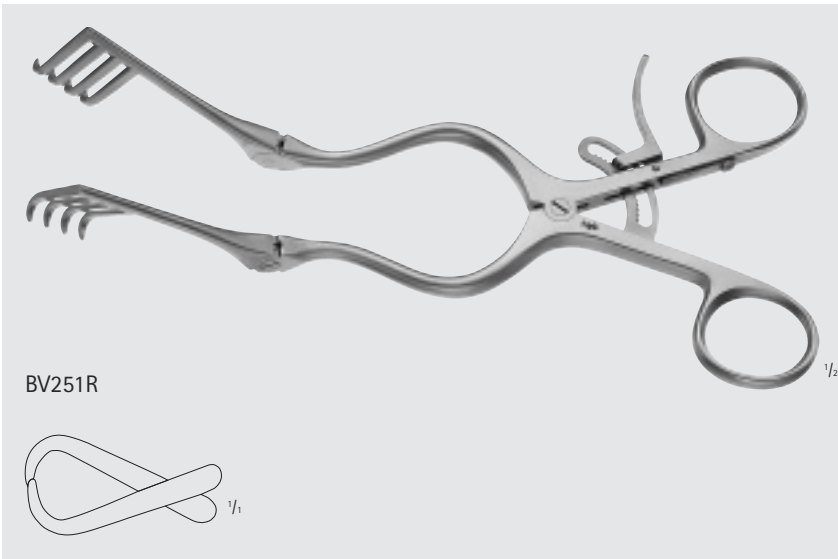

BV251R

ADSON Retractor, Adjustable

Catalog Number	Blade End	Tip	Length (in.)
BV251R	4 x 4 PRONGS	SEMI-S	8 1/2



BV252R

ADSON Retractor

Catalog Number	Blade End	Tip	Length (in.)
BV252R	3 x 4 PRONGS	SHARP	10 1/2

General Surgery

Self Retaining Retractors

GENL

BECKMANN-ADSON Retractor, Adjustable

Catalog Number	Blade End	Tip	Length (in.)
BV271R	4 x 4 PRONGS	SEMI-S	12 1/4
BV272R	4 x 4 PRONGS	SHARP	12 1/4

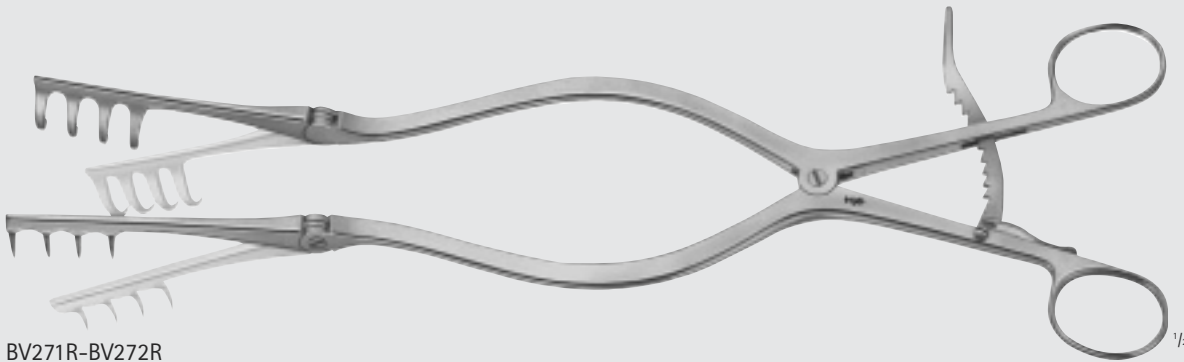

BV271R-BV272R

HARVEY-JACKSON Retractor, Adjustable

Catalog Number	Blade End	Tip	Length (in.)
BV258R	3 x 3 PRONGS	SHARP	11

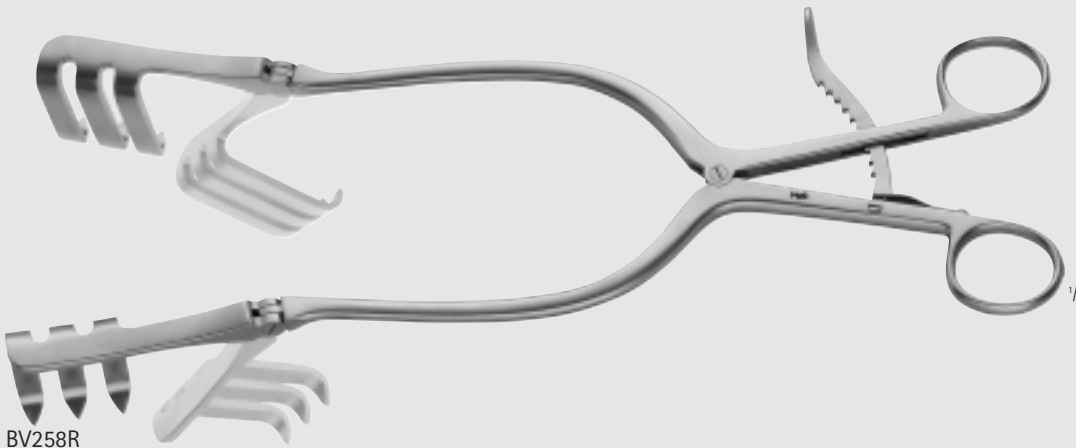

BV258R

MISKIMON Cerebellar Retractor

Catalog Number	Tip	Blade End	Length (in.)
MB476R	SHARP	7 x 7 PRONGS	8

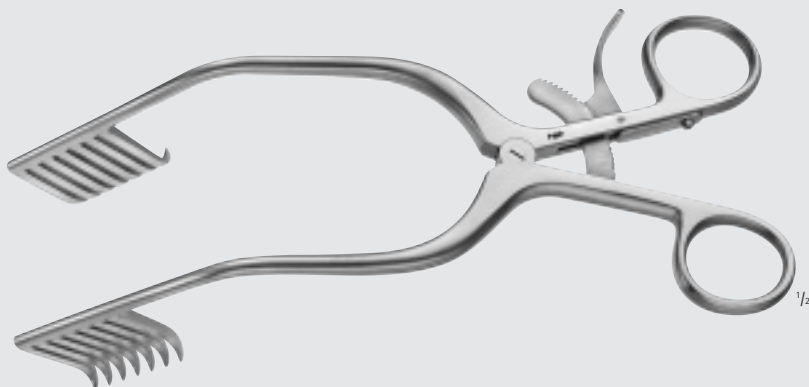

MB476R



INCHES

General Surgery

Self Retaining Retractors

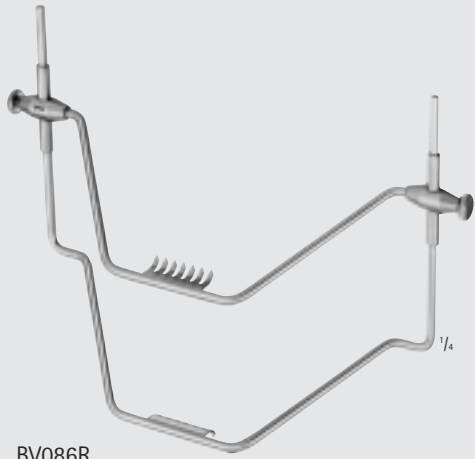

BV086R

Thyroid Retractor

Catalog Number
BV086R

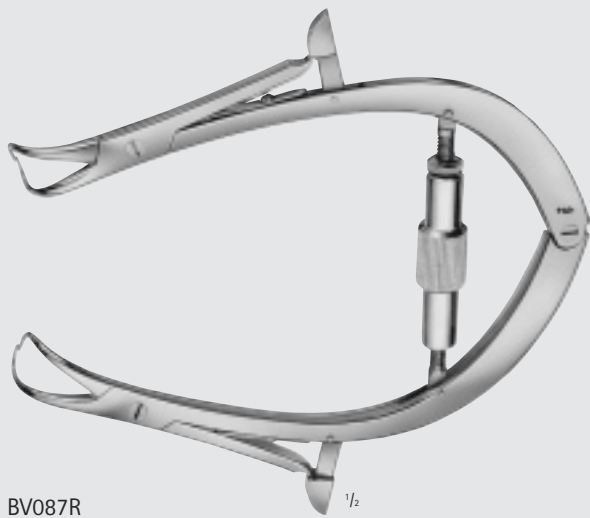
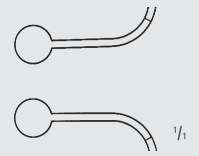

BV087R

JOLL (FRIEDMANN) Thyroid/Vaginal Retractor

Catalog Number	Length (in.)
BV087R	6

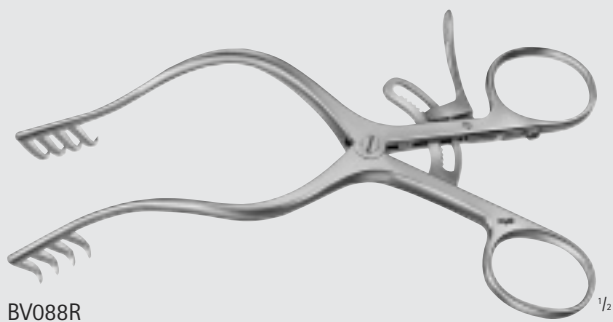

BV088R

MOLLISON Retractor

Catalog Number	Blade End	Tip	Length (in.)
BV088R	4 x 4 PRONGS	SHARP	6

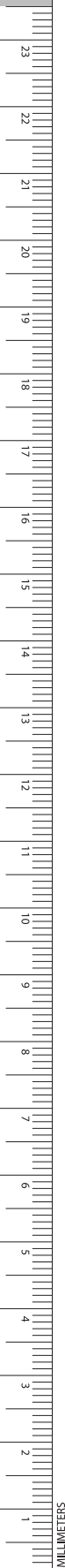
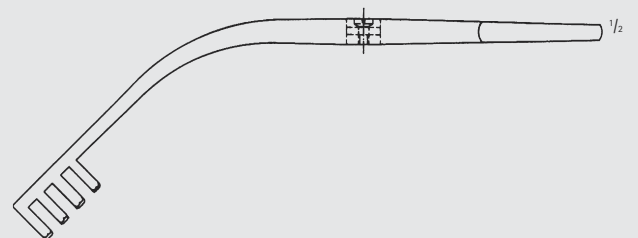
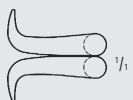

MAYO-ADAMS Retractor

Catalog Number	Length (in.)
BV112R	6 1/2

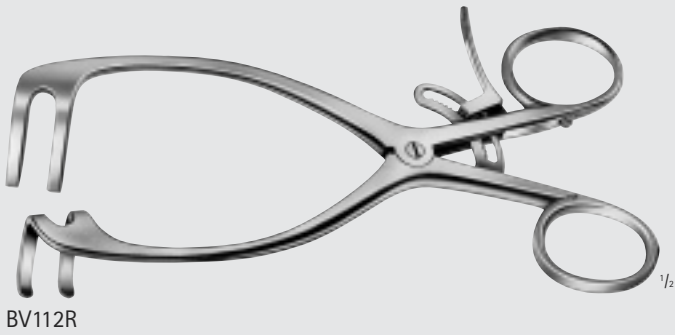

BV112R

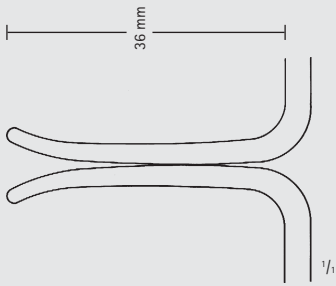

GELPI Perineal Retractor

Catalog Number	Tip	Length (in.)
MB199R	BALL/SHARP	7

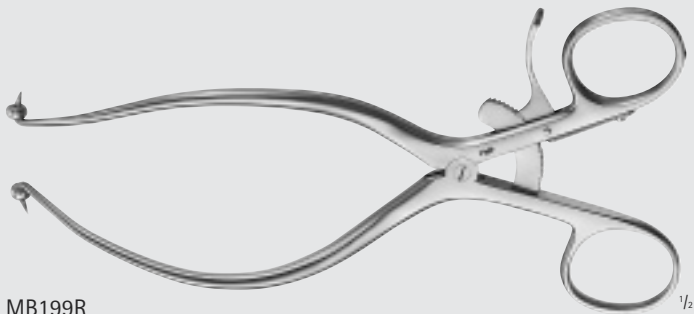

MB199R



General Surgery

Self Retaining Retractors

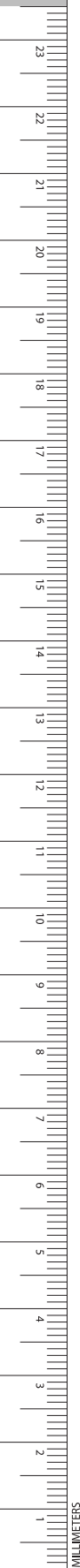

BV996R

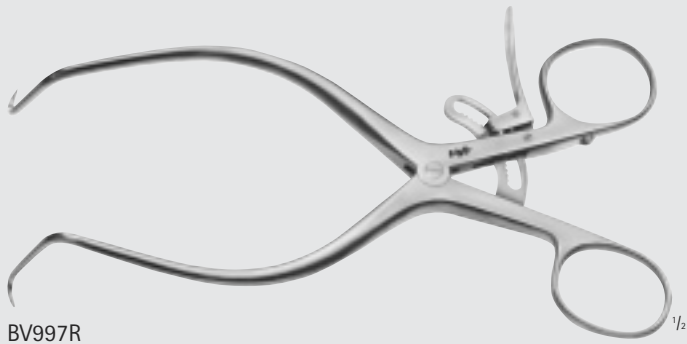
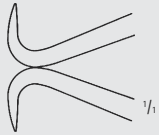

BV997R

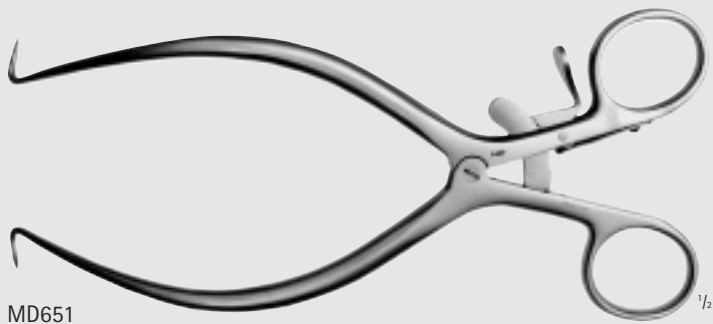
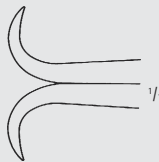

MD651

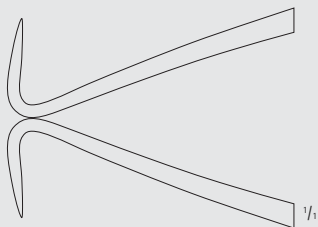

GELPI Vaginal Retractor

Catalog Number	Length (in.)
BV996R	5 1/4
BV997R	7
MD651	7 1/4

DE BAKEY Femur Retractor for Children

Catalog Number	Length (in.)
BV998R	4



BV998R

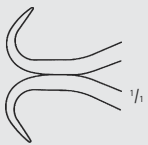

DE BAKEY Femur Retractor for Adults

Catalog Number	Length (in.)
BV999R	5 3/4"

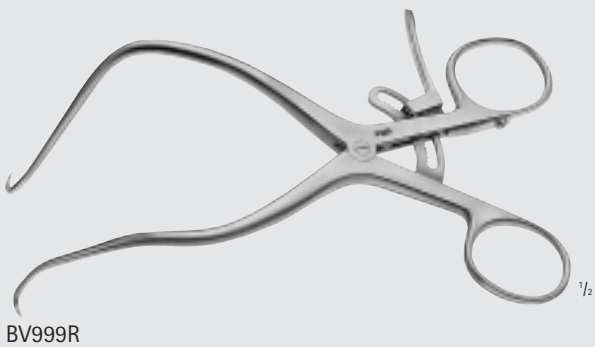

BV999R

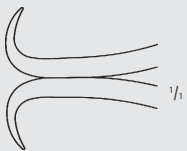

JACKSON-BURROWS Retractor, Blunt

Catalog Number	Length (in.)
BV993R	7 1/4

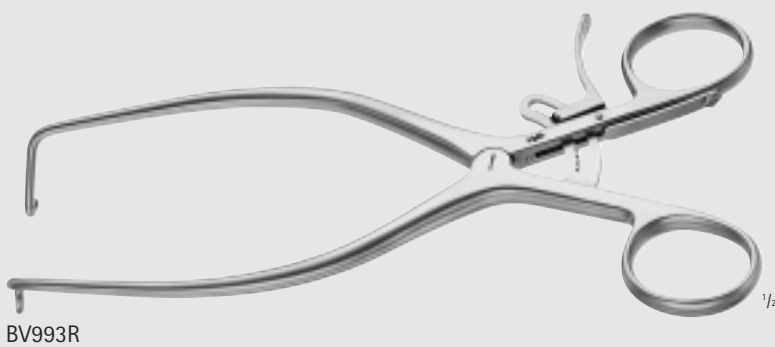

BV993R

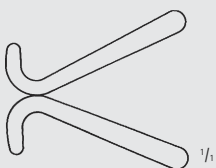

General Surgery

Rectal Specula Instruments

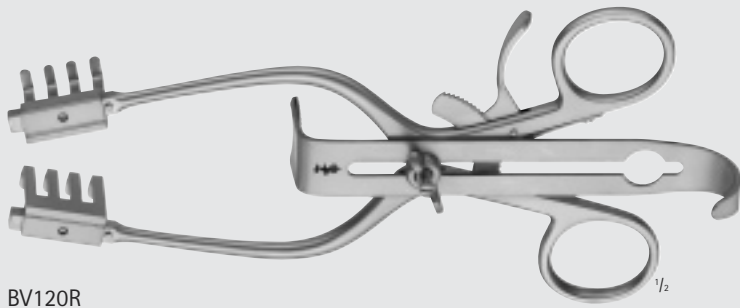

BV120R

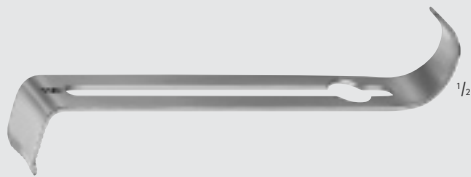

BV120R, MB842R

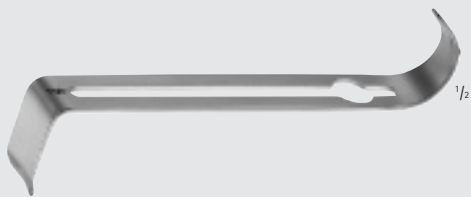

MB843R



MB844R



MB845R



MB846R



MB847R

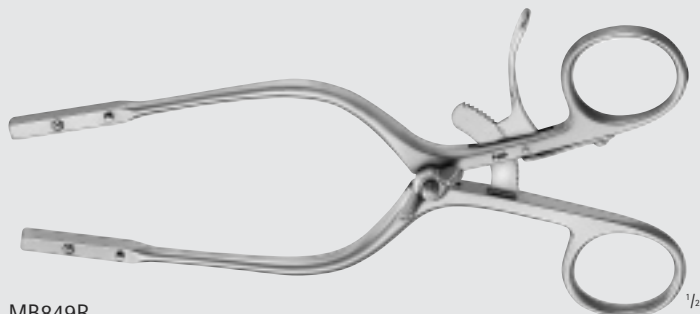

MB849R



MB848R

HENLY Retractor Set

Catalog Number	Item	Blade Size (mm)	Size
BV120R	COMPLETE SET		
MB842R	CENTER BLADE	19 x 16	SMALL
MB843R	CENTER BLADE	25 x 16	MEDIUM
MB844R	CENTER BLADE	32 x 16	LARGE
MB845R	SIDE BLADE	25 x 25	4 PRONGS
MB846R	SIDE BLADE	51 x 25	4 PRONGS
MB847R	SIDE BLADE	76 x 22	4 PRONGS
MB848R	CENTER BLADE	76 x 16	X-LARGE
MB849R	FRAME ONLY		

Materials in set sold separately:
MB842R - MB849R

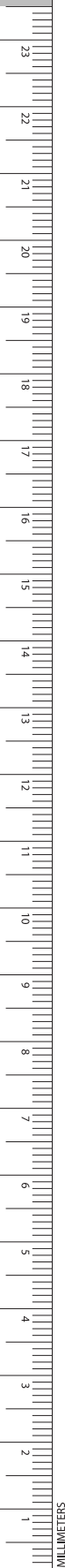

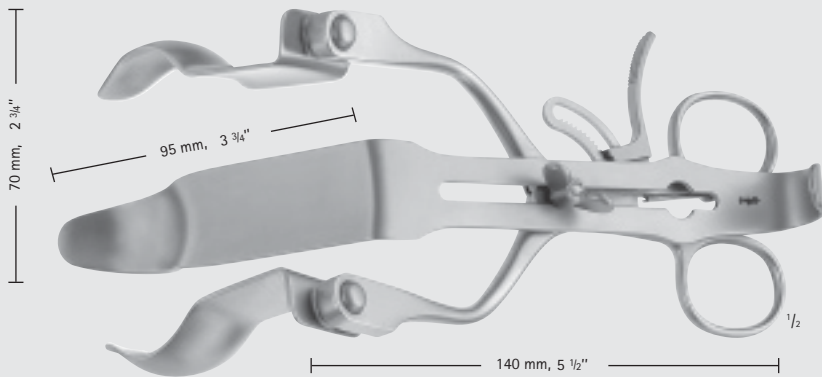

BV581R-BV589R

PARKS Rectal Blades, F/BV581R, 2/Set

Catalog Number	Item	Length (mm)
BV581R	SPREADER ONLY	-
BV582R	CTR-BLD	-
BV583R	-	70
BV584R	-	93
BV585R	SET	-
BV586R	-	90
BV589R	-	150

Set Includes:

- 1 Spreader BV581R
- 1 Center Blade BV582R
- 2 Blades of each BV583R and BV584R

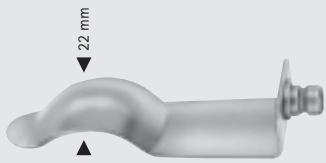

BV583R

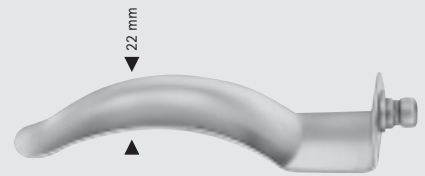

BV585R

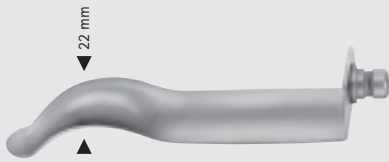

BV586R



BV589R

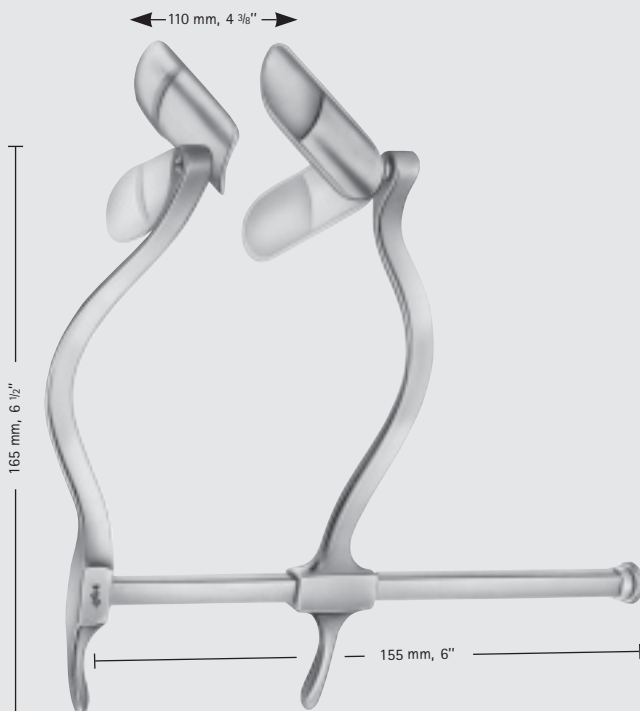

BV906R

SMITH-BUIE Rectal Retractor

Catalog Number	Blade Size (mm)
BV906R	58 x 23



INCHES

General Surgery

Rectal Specula Instruments

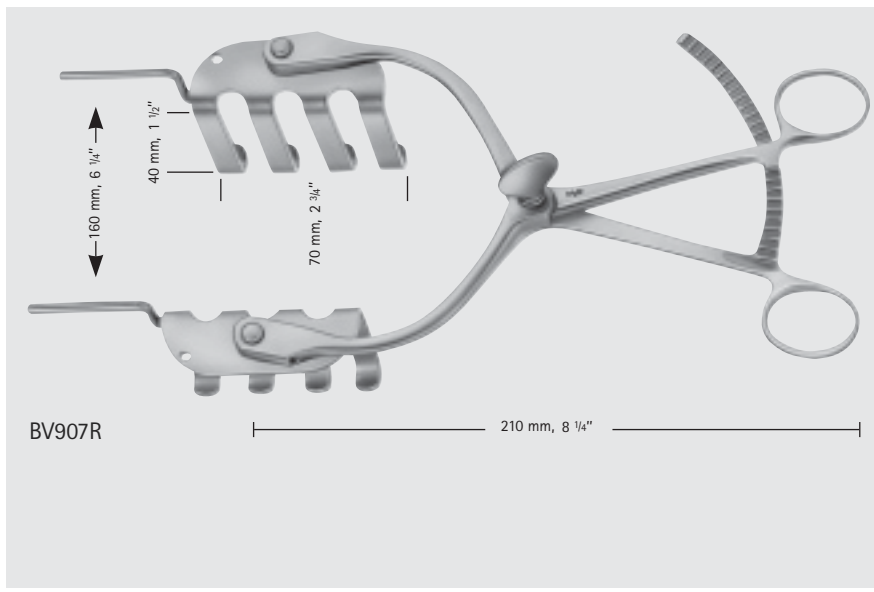

ST. MARKS Perineal Retractor

Catalog Number	
	BV907R

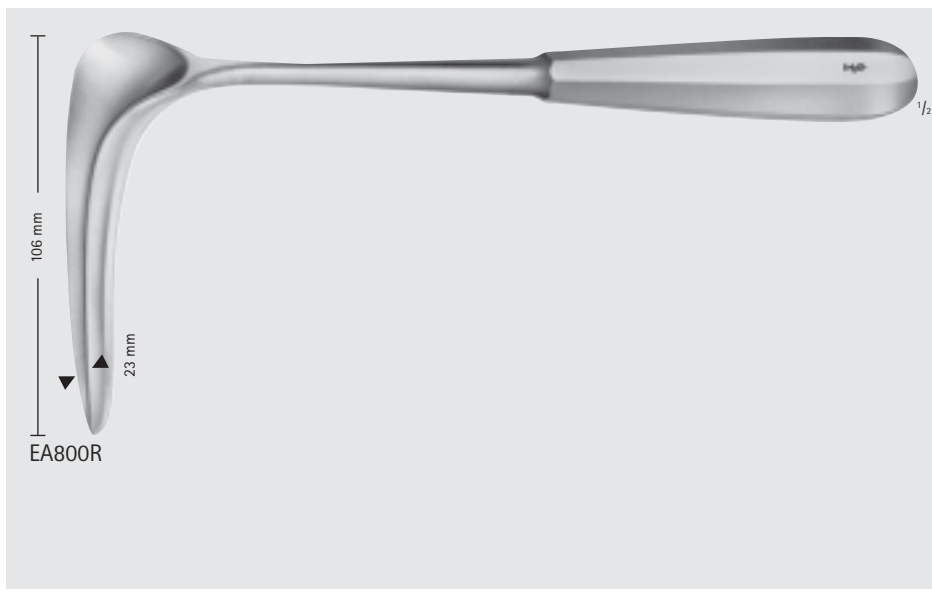

CZERNY Rectal Speculum

Catalog Number	Length (in.)
EA800R	9

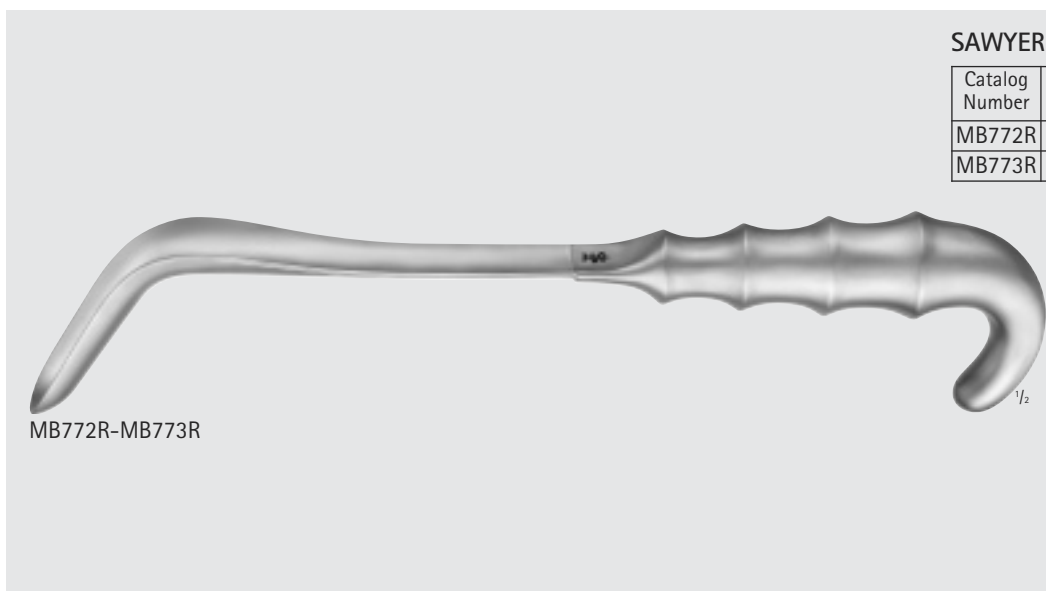

SAWYER Retractors

Catalog Number	Jaw	Blade Size (mm)	Length (in.)
MB772R	MED	82 x 29	10 3/4
MB773R	SM	70 x 19	10 3/4

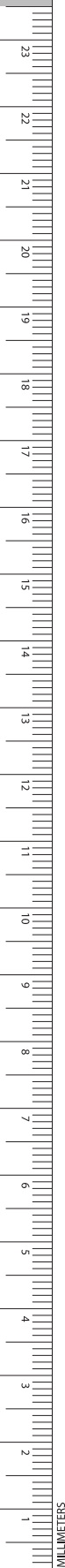

General Surgery

Rectal Specula Instruments

GENL

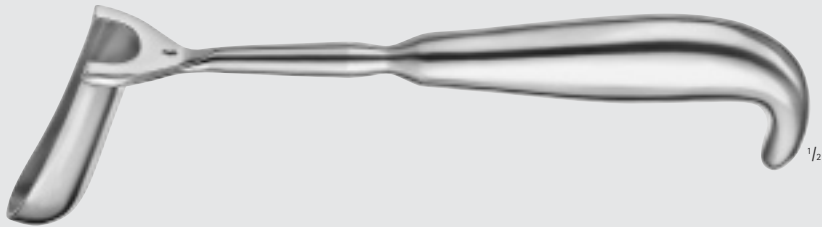

MB774R-MB776R

HILL-FERGUSSON Rectal Retractors

Catalog Number	Blade Size (mm)	Length (in.)
MB774R	76 x 35	8 1/4
MB775R	64 x 24	8 1/4
MB776R	76 x 32	8 1/4



EA820R

SIMS Rectal Speculum

Catalog Number	Blade	Length (in.)
EA820R	SOLID	6 1/4
EA821R	FENESTRATED	6 1/4



EA821R

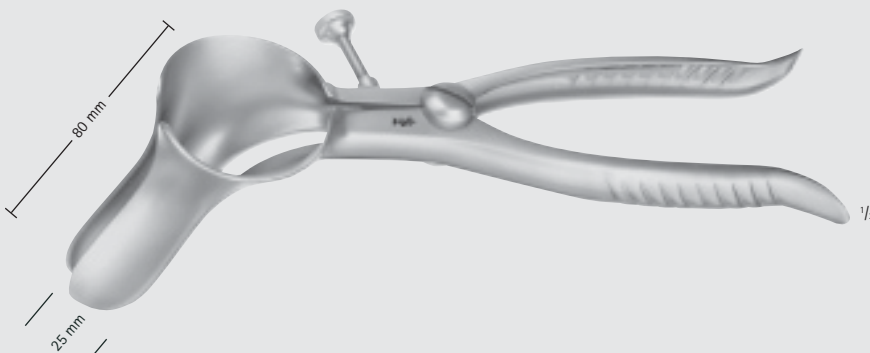

EA831R

PRATT Rectal Speculum

Catalog Number	Length (in.)
EA831R	8



INCHES

General Surgery

Rectal Specula Instruments

GENL

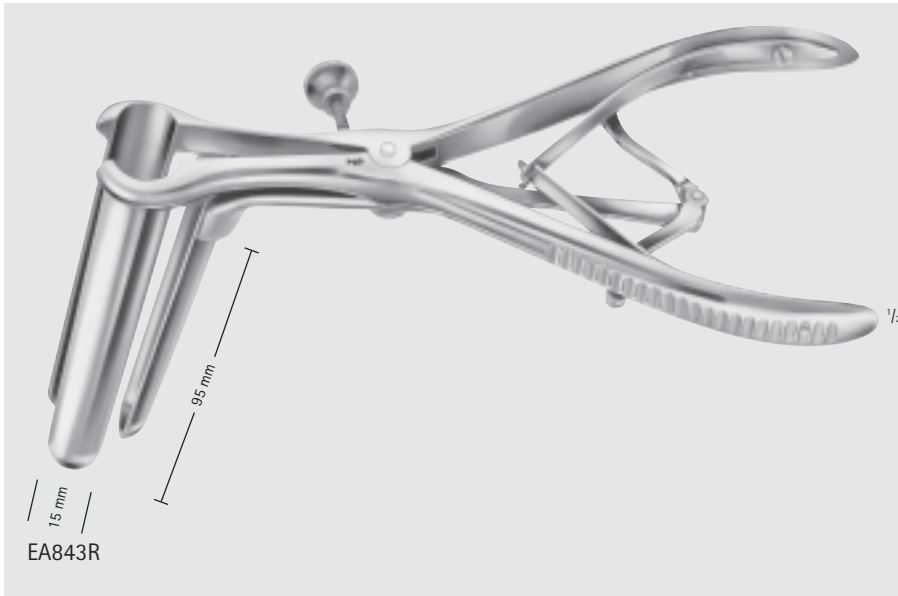
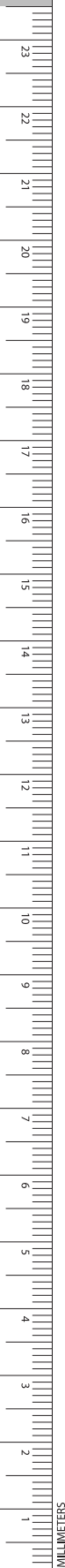

MATHIEU Rectal Speculum

Catalog Number	Length (in.)
EA843R	8 1/2



IVES-FANSLER Anoscope

Catalog Number	Length (in.)
EA880R	5 3/4



Rectal Speculum

Catalog Number	Diameter (in.)
MB274R	2 3/8

General Surgery
Rectal Specula Instruments

GENL



MB284R

BRINKERHOFF Rectal Specula

Catalog Number	Length (in.)
MB284R	4 1/2



EA883R

KELLY Sphincteroscope

Catalog Number	Length (in.)
EA883R	6 1/4

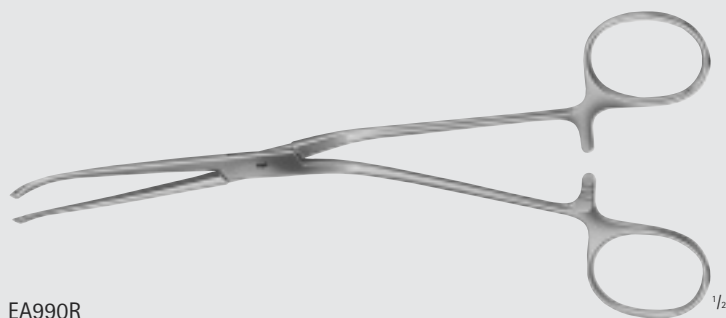

EA990R

MC GIVNEY Hemorrhoidal Forceps

Catalog Number	Length (in.)
EA990R	7 1/4



General Surgery
Rectal Specula Instruments

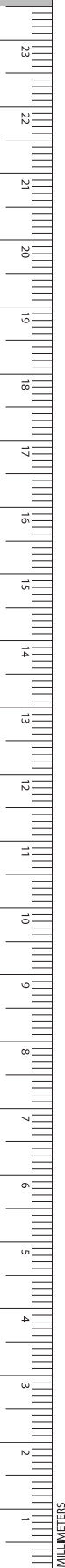

RUDD Hemorrhoidal Ligator,
W/100 Rubber Rings

Catalog Number	Length (in.)
EA991R	12 1/2

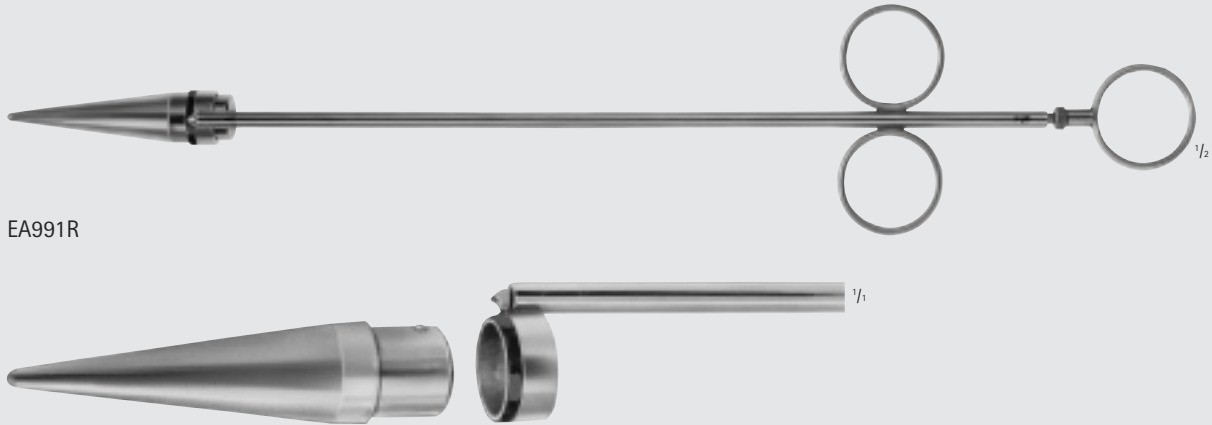

EA991R

Hemorrhoidal Rubber Rings,
F/EA991R, 100/Pkg

Catalog Number
EA993



EA993

STEWART Crypt Hook

Catalog Number	Length (in.)
MB892R	9

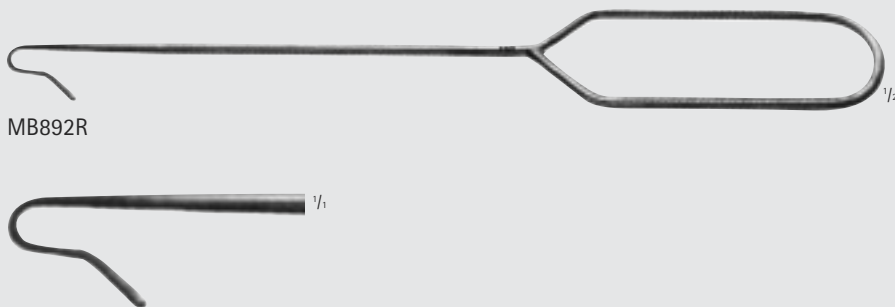

MB892R

BAKES Bile-Duct Dilator

Catalog Number	Tip Size (mm)	Length (in.)
EB061R	1	12 1/2
EB062R	2	12 1/2
EB063R	3	12 1/2
EB064R	4	12 1/2
EB065R	5	12 1/2
EB066R	6	12 3/4
EB067R	7	12 3/4
EB068R	8	12 3/4
EB069R	9	12 3/4
EB070R	10	12 3/4
EB071R	11	12 3/4
EB072R	12	12 3/4
EB073R	13	12 3/4
EB074R	SET, 3-11 mm	

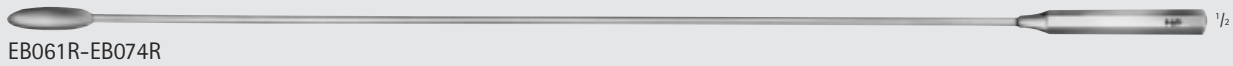

EB061R-EB074R

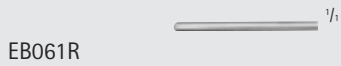

EB061R



EB062R



EB063R



EB064R



EB065R



EB066R



EB067R



EB068R



EB069R



EB070R



EB071R



EB072R



EB073R



INCHES

General Surgery

Probes, Dilators, & Scoops

GENL

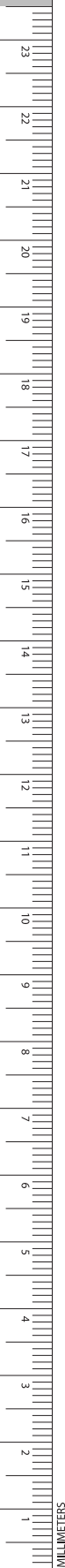

LUER-KOERTE Scoops, Malleable Shaft

Catalog Number	Tip Size (mm)	Length (in.)
EB168R	2.8	12 3/4
EB169R	3.4	12 3/4
EB170R	4.3	12 3/4
EB171R	5.5	12 3/4
EB172R	6.7	12 3/4
EB173R	8.0	12 3/4
EB174R	11.0	12 3/4
EB175R	15.0	12 3/4

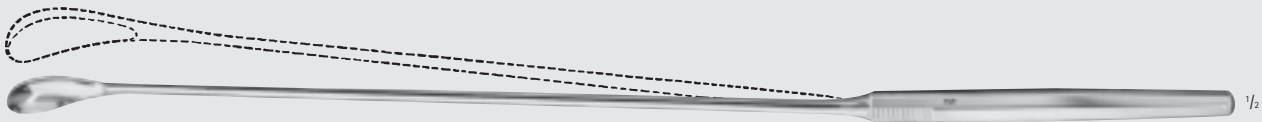

EB168R-EB175R



EB168R

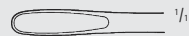

EB169R



EB170R



EB171R



EB172R

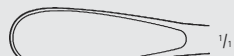

EB173R

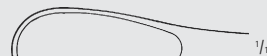

EB174R

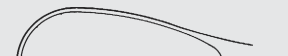

EB175R



BN003R-BN006R

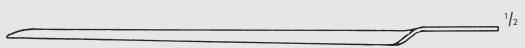

Director W/Tongue

Catalog Number	Blade Shape	Length (in.)
BN003R	STR	5 1/8
BN004R	STR	5 3/4
BN006R	STR	6 1/4



BN010R

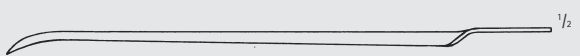

DOYEN Director W/Tongue

Catalog Number	Blade Shape	Length (in.)
BN010R	CVD	5 3/4



MB336R

Grooved Director W/Tongue

Catalog Number	Length (in.)
MB336R	4 1/2

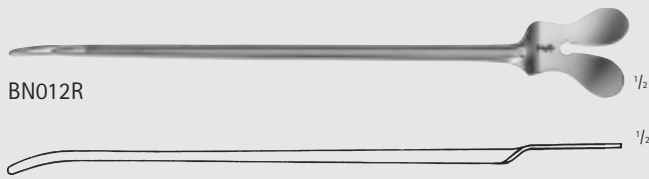

BN012R

NELATON Director

Catalog Number	Blade Shape	Length (in.)
BN012R	CVD	6 1/4

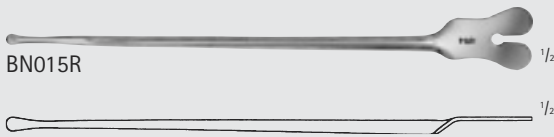

BN015R

Director, W/Probe Tip & Tongue

Catalog Number	Diam. of Tip (mm)	Blade Shape	Length (in.)
BN015R	3.3	STR	5 1/2

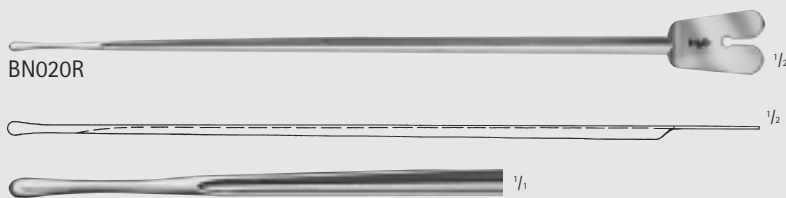

BN020R

BRODIE Director, W/Probe Tip/Tongue

Catalog Number	Diam. of Tip (mm)	Blade Shape	Length (in.)
BN020R	3.5	STR	8

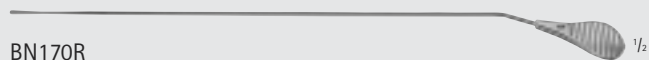

BN170R

Probe

Catalog Number	Diameter (mm)	Length (in.)
BN170R	1.4	6 1/4



INCHES

General Surgery

Probes, Dilators, & Scoops

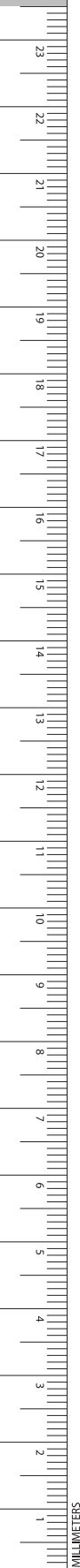

BN021R



BN022R

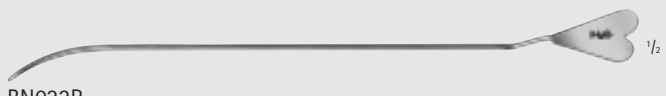

BN023R



BN024R

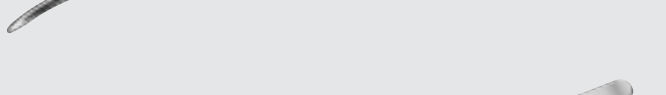

BN025R

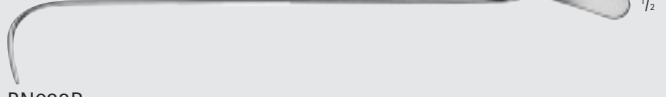

BN026R



BN027R



BN028R

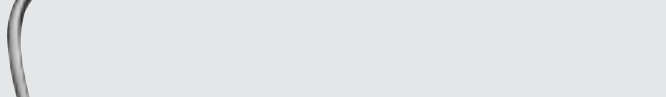

BN029R

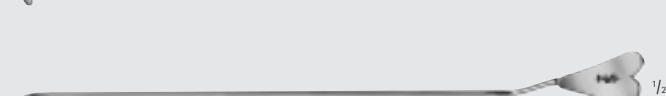

BN030R

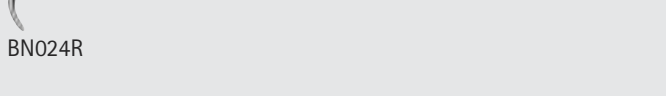

BN031R

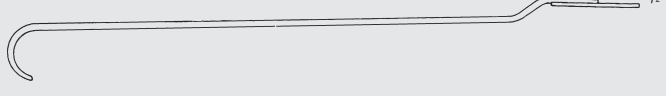

BN032R

LOCKHART-MUMMERY Fistula Probe

Catalog Number	Blade Shape	Length (in.)
BN021R	#1-STR	6 1/2
BN022R	#2-SLT-CVD	6 1/2
BN023R	#3-CVD	6 1/2
BN024R	#4-HVY-CVD	6 1/2

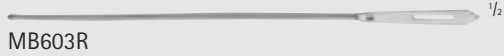

MB603R

Probe W/Eye

Catalog Number	Tip Size (mm)	Length (in.)
MB603R	1.5	5

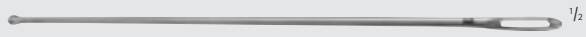

BN034R-BN040R

Probe W/Eye

Catalog Number	Tip Size (mm)	Length (in.)
BN034R	2.5	5 3/4
BN036R	2.5	6 1/4
BN040R	3	8



BN054R



BN063R-BN070R

Myrtle Leaf Probe

Catalog Number	Tip Size (mm)	Length (in.)
BN054R	1.5	5 3/4
BN063R	2	5 1/8
BN064R	2	5 3/4
BN066R	2	6 1/4
BN068R	2	7
BN070R	2	8



BN104R-BN150R

Double Ended Probe

Catalog Number	Tip Size (mm)	Length (in.)
BN104R	1	5 3/4
BN113R	1.5	5 1/8
BN114R	1.5	5 3/4
BN116R	1.5	6 1/4
BN118R	1.5	7
BN120R	1.5	8
BN125R	1.5	10
BN134R	2.0	5 3/4
BN136R	2.0	6 1/4
BN138R	2.0	7
BN140R	2.0	8
BN150R	2.0	12



BN090R

Double Ended Probe W/Eye, Malleable

Catalog Number	Tip Size (mm)	Length (in.)
BN090R	3.0	7 1/2
BN095	3.5	10
BN096	3.5	12



BN095-BN096

General Surgery

Probes, Dilators, & Scoops

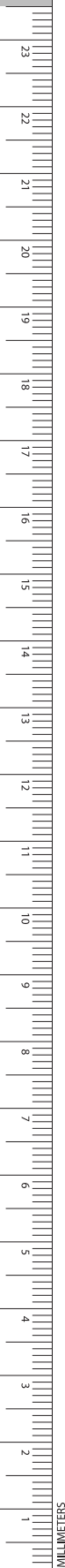

Probe

Catalog Number	Tip Size (mm)	Length (in.)
BN101R	2	12

BN101R

MOYNIHAN Gall Duct Probe

Catalog Number	Tip Size (mm)	Length (in.)
EB050	5	14 1/2

EB050

OCHSNER Gall Duct Probe

Catalog Number	Tip Size (mm)	Length (in.)
EB052C	3.5	16

EB052C

FERGUSON Gall Stone Scoop, Double Ended

Catalog Number	Length (in.)
MB697R	9 1/2
MB698R	9 1/2
MB699R	9 1/2

MB697R-MB699R

Fistula Probe, Crypt Hook

Catalog Number	Length (in.)
EA890R	9 1/2



DESJARDINS Gall Duct Probe, Flexible

Catalog Number	Tip Size (mm)	Length (in.)
EB101R	3.8	11 1/4
EB102R	4.3	11 1/4
EB103R	6.8	11 1/4

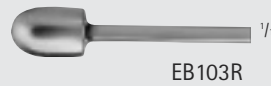
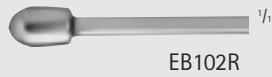
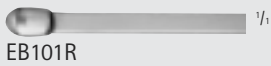
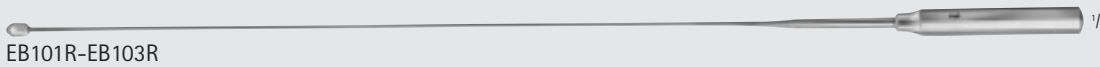

DESJARDINS Gall Stone Scoops

Catalog Number	Tip Size (mm)	Length (in.)
EB111R	6	12
EB112R	7	12
EB113R	8	12
EB114R	9	12

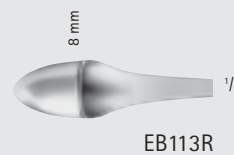
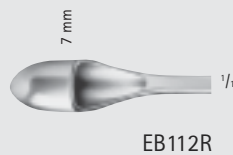
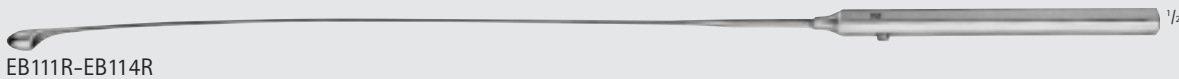

MAYO Gall Duct Probe

Catalog Number	Tip Size (mm)	Tip	Length (in.)
E0005R	5	MALLEABLE	13 1/8



General Surgery

Scalpel Handles

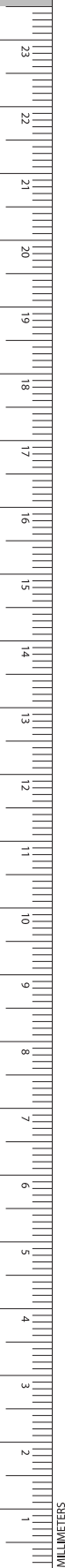

Scalpel Handle #3, F/Blades nos.10-15, 40, 42

Catalog Number	Length (in.)
BB046R	5 1/4
BB048R	6
BB070R	6



BB046R



BB048R



BB070R

CASPAR Scalpel Handle

Catalog Number	Length (in.)
BB052R	7



LANDOLT Scalpel Handle, F/Microsurgery Blades

Catalog Number	Length (in.)
BB053R	8 1/4
BB057R	10



BB053R



1/2



1/2



BB057R



BB331R



BB332R

**YASARGIL Arachnoid Blades
F/LANDOLT Scalpel Handles**

Catalog Number	Tip Size (mm)	Packaging
BB331R	1.5	10/BOX
BB332R	2.5	10/BOX



BB365R



BB367R

Sterile Microsurgery Blades

Catalog Number	Tip	Packaging
BB365R	MINI #11	10/BOX
BB367R	MINI #15	10/BOX



BB054R

Scalpel Handle, F/Micro Blades

Catalog Number	Length (in.)
BB054R	8

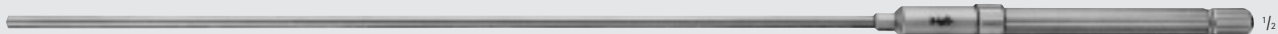

BB060R

Scalpel Handle

Catalog Number	Length (in.)
BB060R	12



BB071R



**Scalpel Handle, Offset,
F/Blades nos. 10-15, 40, 42**

Catalog Number	Length (in.)
BB071R	8 1/4



BB068R

**BARRON Scalpel Handle #3, F/Blades
nos. 10-15, 40, 42**

Catalog Number	Length (in.)
BB068R	5 1/8



INCHES

General Surgery

Scalpel Handles

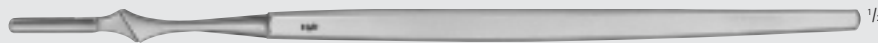
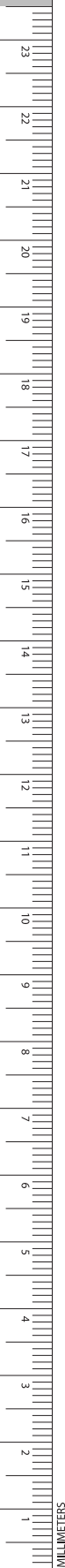

BB080R

Scalpel Handle #4, F/Blade nos. 18-36

Catalog Number	Length (in.)
BB080R	9



BB074R

Scalpel Handle #3, W/mm/inch Scale, F/Blades nos. 10-15, 40, 42

Catalog Number	Length (in.)
BB074R	5



BB075R

Scalpel Handle #3L, F/Blades nos. 10-15, 40, 42

Catalog Number	Length (in.)
BB075R	8 1/4



BB175R

Scalpel Handle #3XL, F/Blades nos. 10-15, 40, 42

Catalog Number	Length (in.)
BB175R	10



BB084R

Scalpel Handle #4, F/Blades nos. 18-36

Catalog Number	Length (in.)
BB084R	5 1/4



BB077R

Scalpel Handle #7, F/Blades nos. 10-15, 40, 42

Catalog Number	Length (in.)
BB077R	6 1/4



MB104R

Scalpel Handle #3, F/Blades
nos. 10-15, 40, 42

Catalog Number	Length (in.)
MB104R	4



MB127R

Scalpel Handle #3L, F/Blades
nos. 10-15, 40, 42

Catalog Number	Blade Shape	Length (in.)
MB127R	ANG	8



BB078R

Scalpel X-Long Handle, #3, F/Blades
nos. 10-15, 40, 42

Catalog Number	Blade Shape	Length (in.)
BB078R	STR	9



INCHES

General Surgery

Scalpel Handles



BB079R

Scalpel X-Long Handle, #3, F/Blades nos. 10-15, 40, 42

Catalog Number	Blade Shape	Length (in.)
BB079R	ANG	9



BB085R

Scalpel Handle #4L, F/Blades nos. 18-36

Catalog Number	Length (in.)
BB085R	8 1/2



BB087R

Scalpel Handle #4XL, F/Blades nos. 18-36

Catalog Number	Length (in.)
BB087R	10



BB089R

Scalpel Handle #9, F/Blades nos. 18-36

Catalog Number	Length (in.)
BB089R	5 3/4

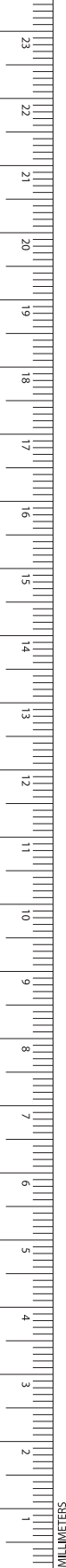



BB510, 16600495



BB511, 16600509



BB512, 16600517



BB515, 16600525



BB540

double cutting

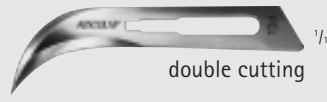

BB542

double cutting

Sterile Scalpel Blade, For #3 Handle

Catalog Number		Blade Number	Packaging
Carbon	Stainless Steel		
BB510	16600495	#10	100/BOX
BB511	16600509	#11	100/BOX
BB512	16600517	#12	100/BOX
BB515	16600525	#15	100/BOX
BB540		#40	100/BOX
BB542		#12D	100/BOX

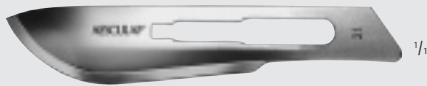

BB521, 16600568



BB523, 16600584



BB520, 16600550



BB536, 16615522



BB522, 16600576



BB524, 16600592



BB525, 16616634

Sterile Scalpel Blade, For #4 Handle

Catalog Number		Blade Number	Packaging
Carbon	Stainless Steel		
BB520	16600550	#20	100/BOX
BB521	16600568	#21	100/BOX
BB522	16600576	#22	100/BOX
BB523	16600584	#23	100/BOX
BB524	16600592	#24	100/BOX
BB525	16616634	#25	100/BOX
BB536	16615522	#36	100/BOX



BB500, 16600487

Sterile Stitch Cutter Blade

Catalog Number		Packaging
Carbon	Stainless Steel	
BB500	16600487	100/BOX

General Surgery

Sterile Scalpels With Plastic Handle



BA210-5518059 $\frac{1}{2}$



BA210, 5518059 $\frac{1}{2}$



BA211, 5518040 $\frac{1}{2}$



BA212, 5518105 $\frac{1}{2}$



BA215, 5518032 $\frac{1}{2}$



BA218 $\frac{1}{2}$



BA219 $\frac{1}{2}$

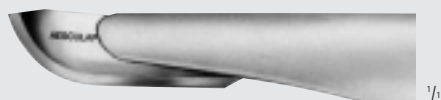

BA220, 5518067 $\frac{1}{2}$



BA221, 5518075 $\frac{1}{2}$



BA222, 5518083 $\frac{1}{2}$



BA223, 5518016 $\frac{1}{2}$

Sterile Scalpels W/Plastic Handle and Blade Protector

Catalog Number		Size	Packaging
Carbon	Stainless Steel		
BA210	5518059	10	10/BOX
BA211	5518040	11	10/BOX
BA212	5518105	12	10/BOX
BA215	5518032	15	10/BOX
BA218		18	10/BOX
BA219		19	10/BOX
BA220	5518067	20	10/BOX
BA221	5518075	21	10/BOX
BA222	5518083	22	10/BOX
BA223	5518016	23	10/BOX
BA224	5518091	24	10/BOX



BA224, 5518091 $\frac{1}{2}$

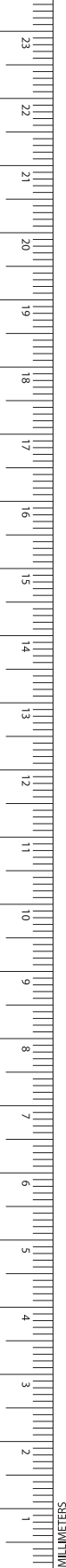

General Surgery
Amputation & Autopsy Instruments

GENL

LISTON Amputating Knife

Catalog Number	Blade Length (mm)	Blade Length (in.)
FH100R	130	5 1/8
FH101R	160	6 1/4
FH102R	190	7 1/2
FH103R	220	8 3/4



FH100R-FH103R

CATLIN Amputating Knife, Double Cutting

Catalog Number	Blade Length (mm)	Blade Length (in.)
FH116R	160	6 1/4



FH116R



INCHES

General Surgery

Amputation & Autopsy Instruments

GENL

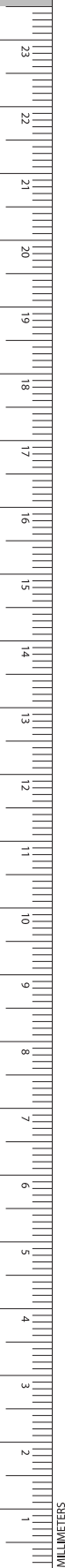

FH300R



FH301C-FH302C

CHARRIÈRE Amputation Saw, 2 Blades

Catalog Number	Item	Blade Size (in.)	Total Length (in.)
FH300R	SAW COMPLETE	8 1/2	14
FH301C	CARBON STEEL BLADE	8 1/2	
FH302C	CARBON STEEL BLADE	8 1/2	



FH320R

CHARRIÈRE Amputation Saw

Catalog Number	Item	Blade Size (in.)	Total Length (in.)
FH320R	SAW COMPLETE	7 1/4	10 1/2

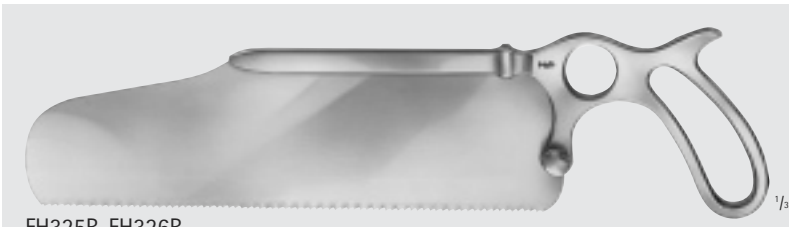

FH325R-FH326R

SATTERLEE Amputation Saw

Catalog Number	Item	Blade Length (in.)	Total Length (in.)
FH325R	SAW COMPLETE	8	11 1/2
FH326R	CARBON STEEL BLADE F/FH325R		

General Surgery
Amputation & Autopsy Instruments

GENL

LANGENBECK Metacarpal Saw

Catalog Number	Length (in.)
FH335R	9 1/4



FH335R

GIGLI Wire Saw, Fine, 6-Wires

Catalog Number	Packaging	Length (in.)
FH414	5/BOX	16
FH415	5/BOX	20

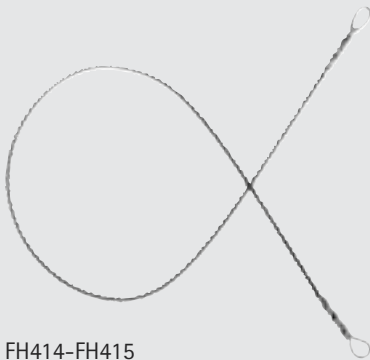

FH414-FH415



5:1

GIGLI Hook Handle, F/Wire Saws

Catalog Number
FH480R



FH480R



INCHES

General Surgery

Suction Cannula

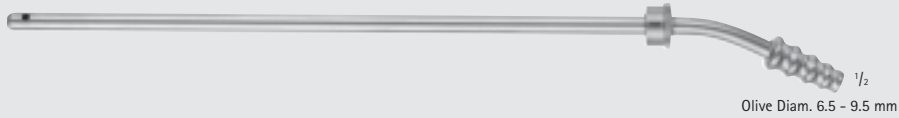

GF860R

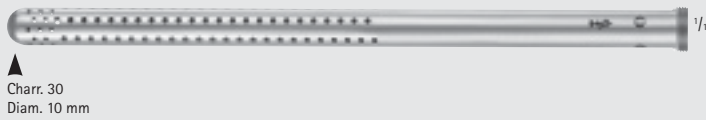

GF862R

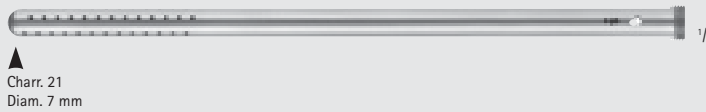

POOL Suction Cannula

Catalog Number	Blade Shape	Length (in.)
GF860R	CVD	9
GF862R	STR	9



GF917R

ADSON Suction Cannula

Catalog Number	Tip Size (mm)	Tip Size (FR)	Length (in.)
GF917R	4	11	7 1/2



GF919R

Nasal Suction Tube, Luer Hub

Catalog Number	Tip Size (mm)	Length (in.)
GF919R	5	7



GF933R

FERGUSSON Suction Cannula

Catalog Number	Tip	Tip Size (mm)	Length (in.)
GF933R	ROUND	4	7

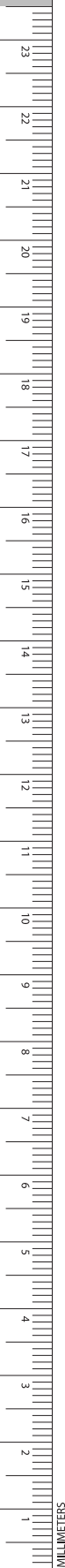

COOLEY Suction Tube

Catalog Number	Tip Size (mm)	Length (in.)
GF821R	8.0	13 1/4



COOLEY Suction Tube W/Detachable Tip

Catalog Number	Tip Size (mm)	Length (in.)
GF822R	8.0	12 1/4
GF823R	9.0	11 3/4
GF824R	8.0	12 3/4

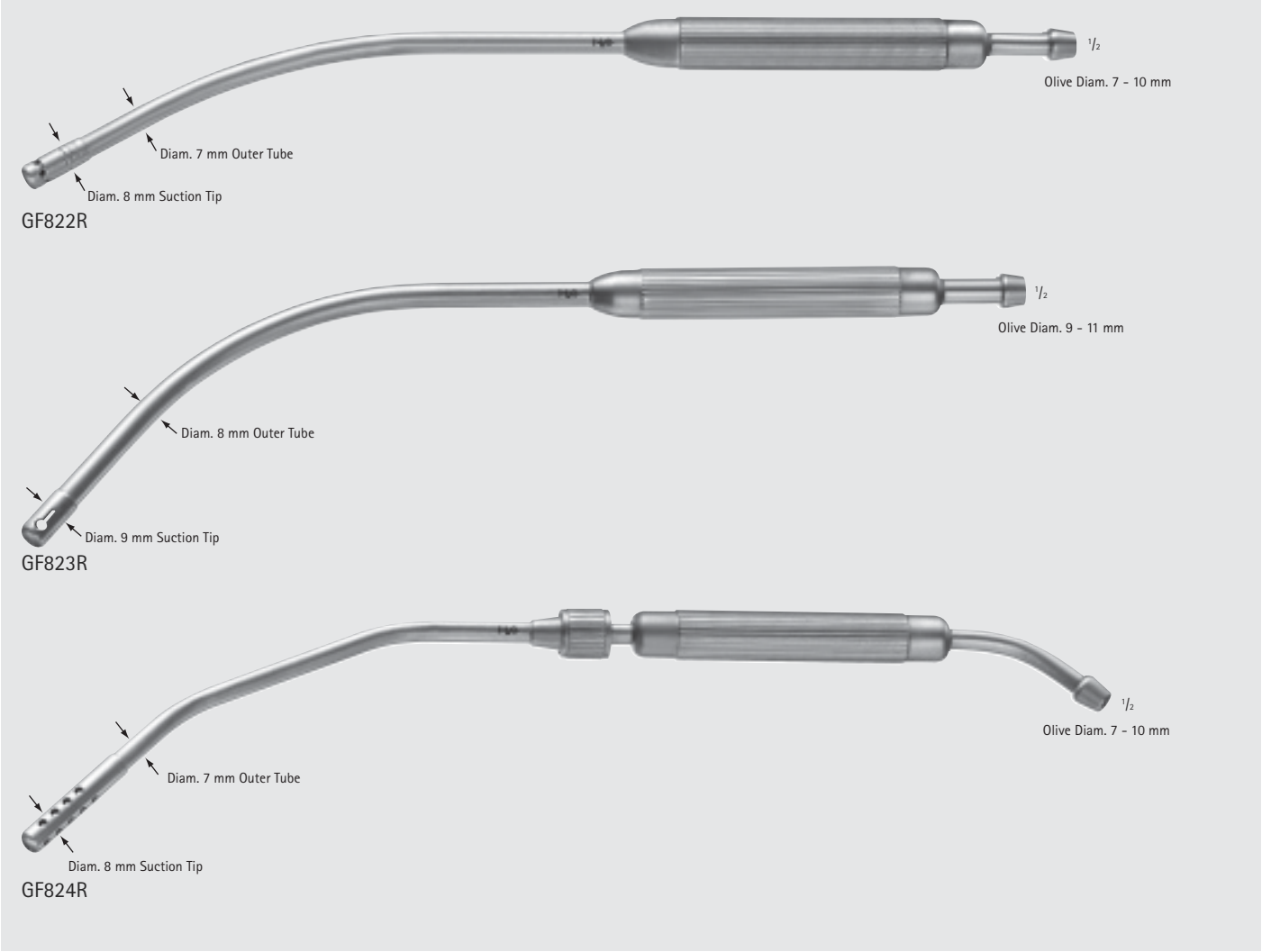

General Surgery

Suction Cannula

COOLEY Suction Tube W/Detachable Tip (continued)

Catalog Number	Length (in.)
GF825R	10 1/2

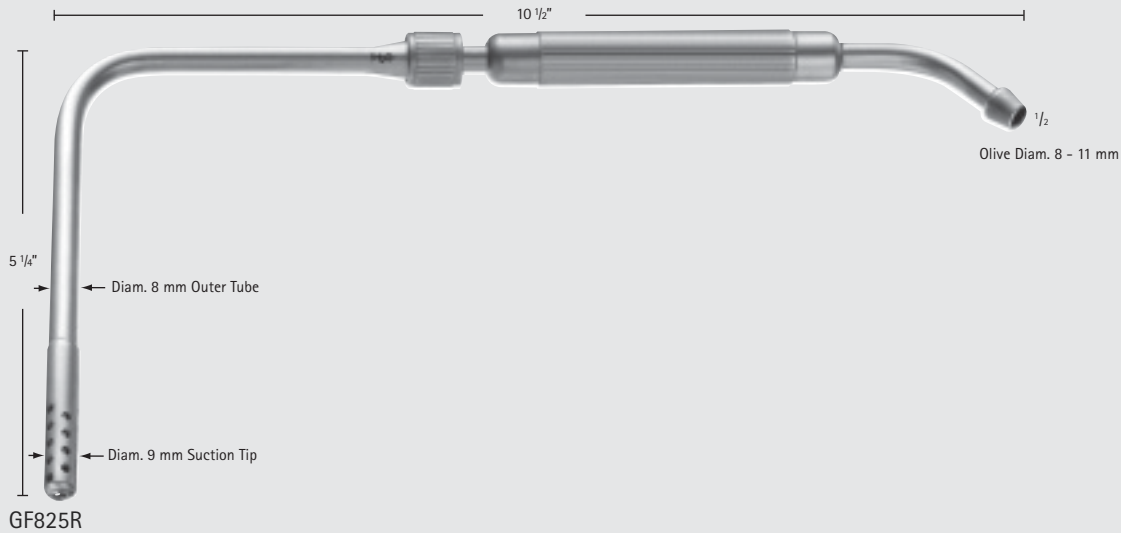

FERGUSON Suction Cannula, Luer Hub

Catalog Number	Diameter (mm)	Working Length (in.)	Length (in.)
GF350R	1.5	4 3/8	7 3/4
GF352R	2.5	4 3/8	7 3/4
GF354R	4.0	4 3/8	7 3/4
GF355R	5.0	4 3/8	7 3/4
GF360R	1.5	5 1/8	8 1/2
GF361R	2.0	5 1/8	8 1/2
GF362R	2.5	5 1/8	8 1/2
GF363R	3.0	5 1/8	8 1/2
GF364R	4.0	5 1/8	8 1/2
GF365R	5.0	5 1/8	8 1/2
GF370R	1.5	6 1/4	9 3/4
GF371R	2.0	6 1/4	9 3/4
GF372R	2.5	6 1/4	9 3/4
GF373R	3.0	6 1/4	9 3/4
GF374R	4.0	6 1/4	9 3/4
GF375R	5.0	6 1/4	9 3/4
GF380R	1.5	8	11
GF381R	2.0	8	11
GF382R	2.5	8	11
GF383R	3.0	8	11
GF384R	4.0	8	11
GF385R	5.0	8	11

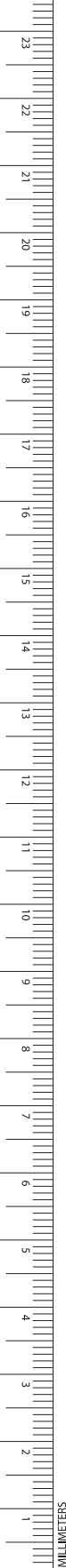
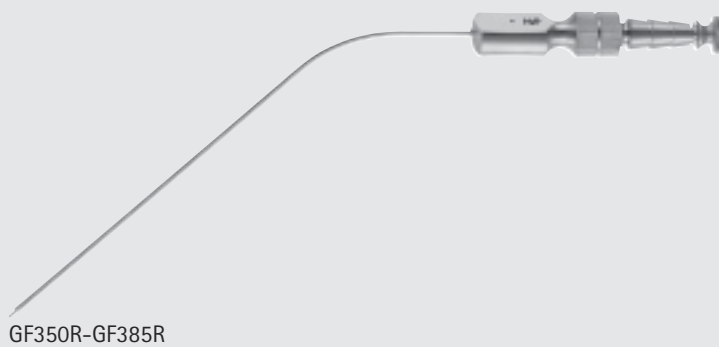

MF479R-MF518R



FRAZIER Slotted Suction Tube

Catalog Number	Tip Size (FR)	Length (in.)
MF479R	3	5 1/2
MF480R	4	5 1/2
MF481R	5	5 1/2
MF482R	6	5 1/2
MF483R	7	5 1/2
MF484R	8	5 1/2
MF485R	9	5 1/2
MF486R	10	5 1/2
MF487R	11	5 1/2
MF488R	12	5 1/2
MF489R	3	5 1/2
MF490R	4	5 1/2
MF491R	5	5 1/2
MF492R	6	5 1/2
MF493R	7	5 1/2
MF494R	8	5 1/2
MF495R	9	5 1/2
MF496R	10	5 1/2
MF497R	11	5 1/2
MF498R	12	5 1/2
MF499R	3	7
MF500R	4	7
MF501R	5	7
MF502R	6	7
MF503R	7	7
MF504R	8	7
MF505R	9	7
MF506R	10	7
MF507R	11	7
MF508R	12	7
MF509R	3	7
MF510R	4	7
MF511R	5	7
MF512R	6	7
MF513R	7	7
MF514R	8	7
MF515R	9	7
MF516R	10	7
MF517R	11	7
MF518R	12	7

YANKAUER Suction Cannula

Catalog Number	Tip Opening (mm)	Length (in.)
GF944R	2.0	11 1/4



GF944R



INCHES

General Surgery

Suction Cannula

YANKAUER Suction Tube, W/Boring

Catalog Number	Tip	Tip Opening (mm)	Length (in.)
OM671R	REMOVABLE	4.8	11 1/4

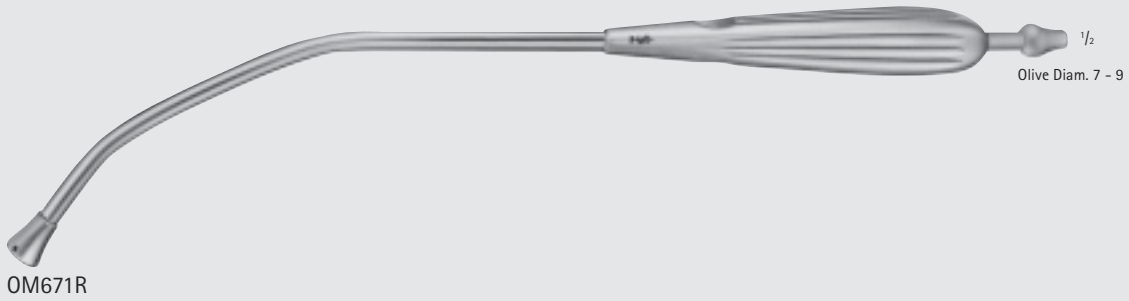

DE BAKEY Suction Cannula

Catalog Number	Tip Size (mm)	Length (in.)
GF946R	3	10 3/4
GF947R	5	6 1/4
GF948R	5	10 3/4

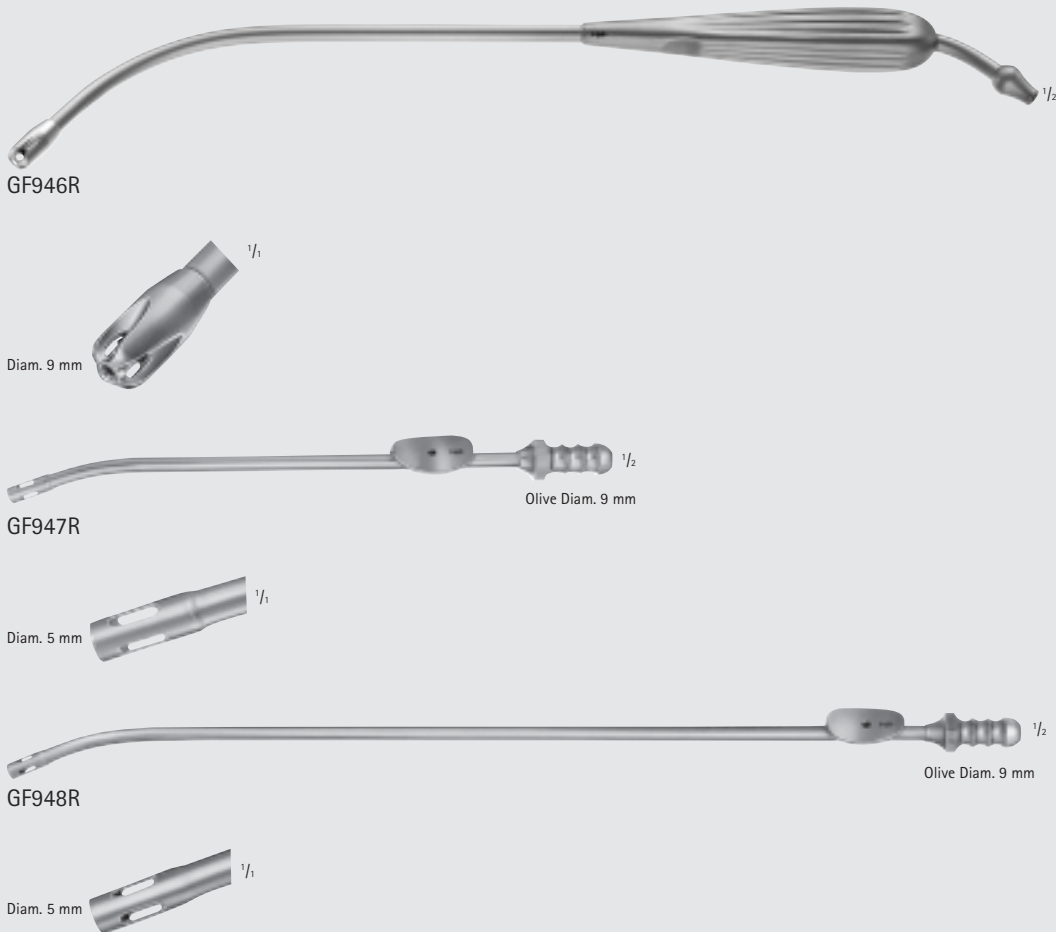

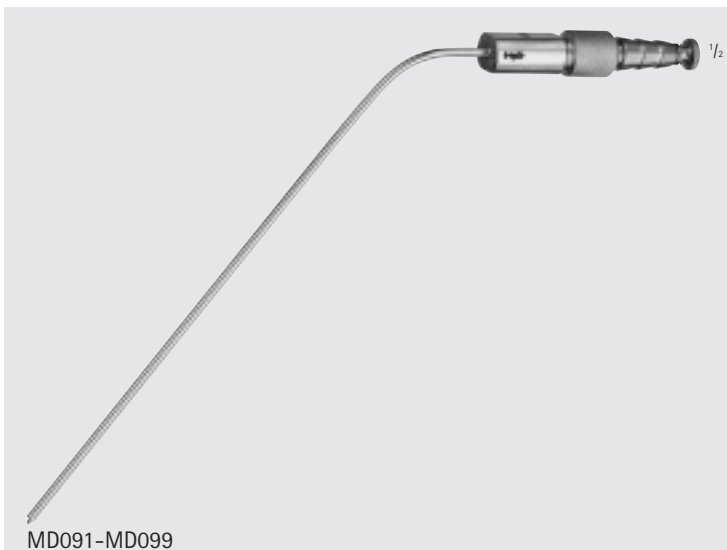

FRAZIER Long-Suction Cannula

Catalog Number	Tip Size (FR)	Length (in.)
MD091	3	6 1/2
MD092	5	6 1/2
MD093	6	6 1/2
MD094	7	6 1/2
MD095	8	6 1/2
MD096	9	6 1/2
MD097	10	6 1/2
MD098	11	6 1/2
MD099	12	6 1/2

MD091-MD099



FRAZIER Suction Cannula, Luer Hub

Catalog Number	Tip Size (FR)	Length (in.)
GF923R	9	7
GF925R	15	7

GF923R-GF925R

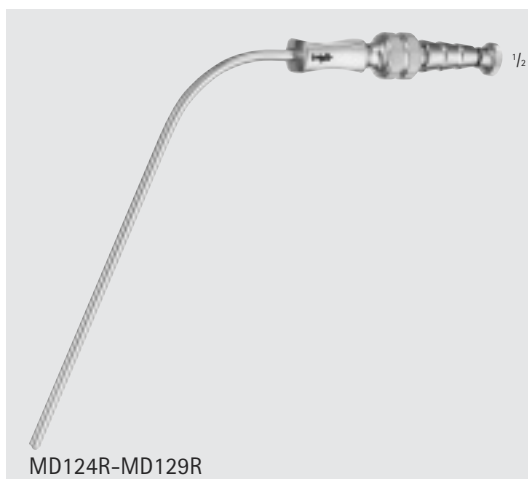

FRAZIER Suction Cannula

Catalog Number	Tip Size (FR)	Length (in.)
MD124R	7	4 1/4
MD125R	8	4 1/4
MD127R	10	4 1/4
MD129R	12	4 1/4

MD124R-MD129R

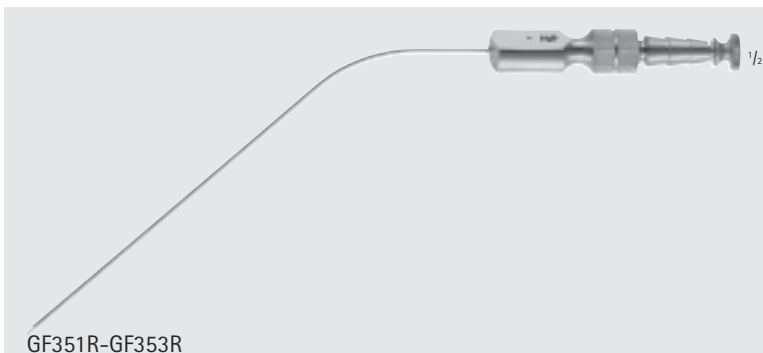

FERGUSON Suction Cannula

Catalog Number	Tip Size (FR)	Length (in.)
GF351R	6	7 3/4
GF353R	9	7 3/4

GF351R-GF353R



General Surgery

Suction Cannula

- Teardrop shaped thumb control for a very precise suction regulation
- Malleable material for individual forming of the suction hose
- Conical design of the tube prevents plugging
- Delivered with stylet

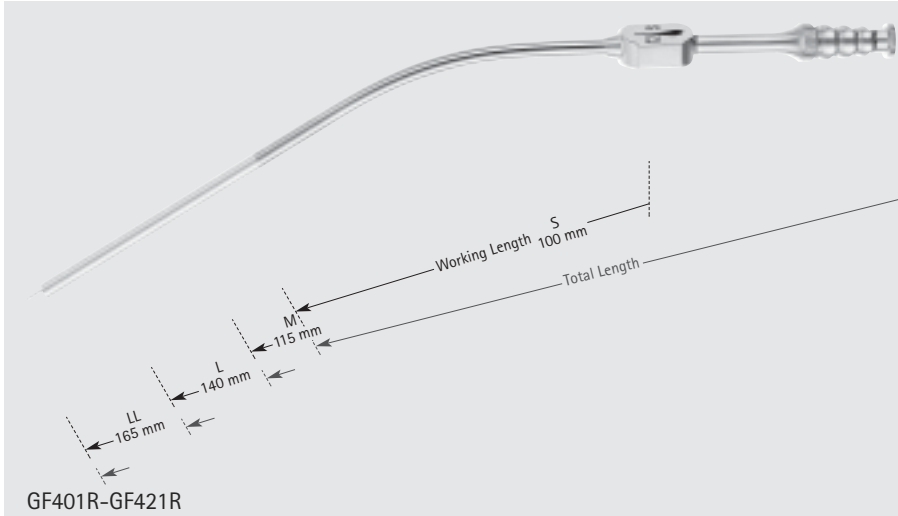

Suction Tube, Fukushima Style, W/Tapered Teardrop Control

Catalog Number	Size	Tip Size (mm)	Tip Size (FR)	Working Length (in.)	Overall Length (in.)
GF401R	S	1.0	3	4	6 1/2
GF391R	M	1.0	3	4 1/2	7
GF411R	L	1.0	3	5 1/2	8
GF421R	LL	1.0	3	6 1/2	9
GF402R	S	1.4	4	4	6 1/2
GF392R	M	1.4	4	4 1/2	7
GF412R	L	1.4	4	5 1/2	8
GF422R	LL	1.4	4	6 1/2	9
GF403R	S	1.7	5	4	6 1/2
GF393R	M	1.7	5	4 1/2	7
GF413R	L	1.7	5	5 1/2	8
GF423R	LL	1.7	5	6 1/2	9
GF404R	S	2.0	6	4	6 1/2
GF394R	M	2.0	6	4 1/2	7
GF414R	L	2.0	6	5 1/2	8
GF424R	LL	2.0	6	6 1/2	9
GF405R	S	2.3	7	4	6 1/2
GF395R	M	2.3	7	4 1/2	7
GF415R	L	2.3	7	5 1/2	8
GF425R	LL	2.3	7	6 1/2	9
GF406R	S	2.7	8	4	6 1/2
GF396R	M	2.7	8	4 1/2	7
GF416R	L	2.7	8	5 1/2	8
GF426R	LL	2.7	8	6 1/2	9
GF407R	S	3.0	9	4	6 1/2
GF397R	M	3.0	9	4 1/2	7
GF417R	L	3.0	9	5 1/2	8
GF427R	LL	3.0	9	6 1/2	9
GF409R	S	4.0	12	4	6 1/2
GF399R	M	4.0	12	4 1/2	7
GF419R	L	4.0	12	5 1/2	8
GF429R	LL	4.0	12	6 1/2	9

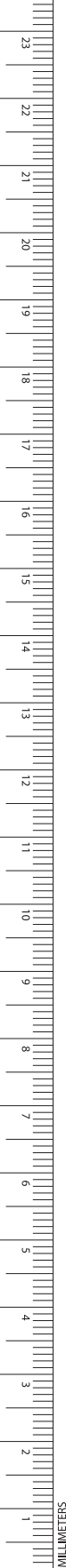



GF980R

Olive Diam. 6 - 9 mm $\frac{1}{2}$

LANDOLT Dissecting Suction Tube

Catalog Number	Tip	Tip Size (mm)	Length (in.)
GF980R	ANG, SHARP	3.2	8

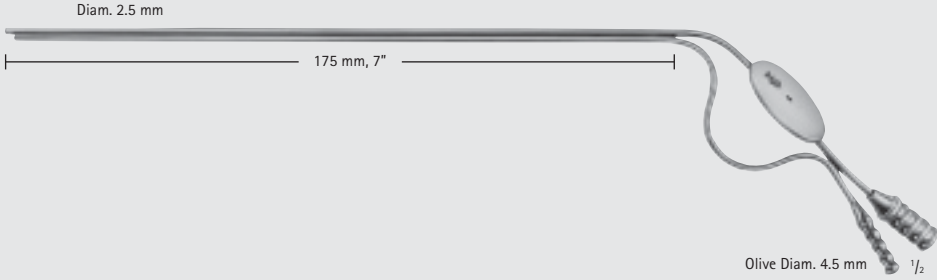

Diam. 2.5 mm

175 mm, 7"

Olive Diam. 4.5 mm $\frac{1}{2}$

Suction/Irrigation Tube, W/Finger Cut-Off and Stylet

Catalog Number	Diam. Suction Tube (mm)	Diam. Irrigation Tube (mm)	Working Length (in.)
GF910R	2.5	2.0	7



MF333R-MF347R

Atraumatic Suction Tube

Catalog Number	Tip Size (FR)	Working Length (in.)	Length (in.)
MF333R	3	3	6 1/4
MF334R	5	3	6 1/4
MF335R	7	3	6 1/4
MF336R	10	3	6 1/4
MF337R	12	3	6 1/4
MF338R	3	4	7 1/4
MF339R	5	4	7 1/4
MF340R	7	4	7 1/4
MF341R	10	4	7 1/4
MF342R	12	4	7 1/4
MF343R	3	5	8 1/4
MF344R	5	5	8 1/4
MF345R	7	5	8 1/4
MF346R	10	5	8 1/4
MF347R	12	5	8 1/4



General Surgery

Suction Cannula

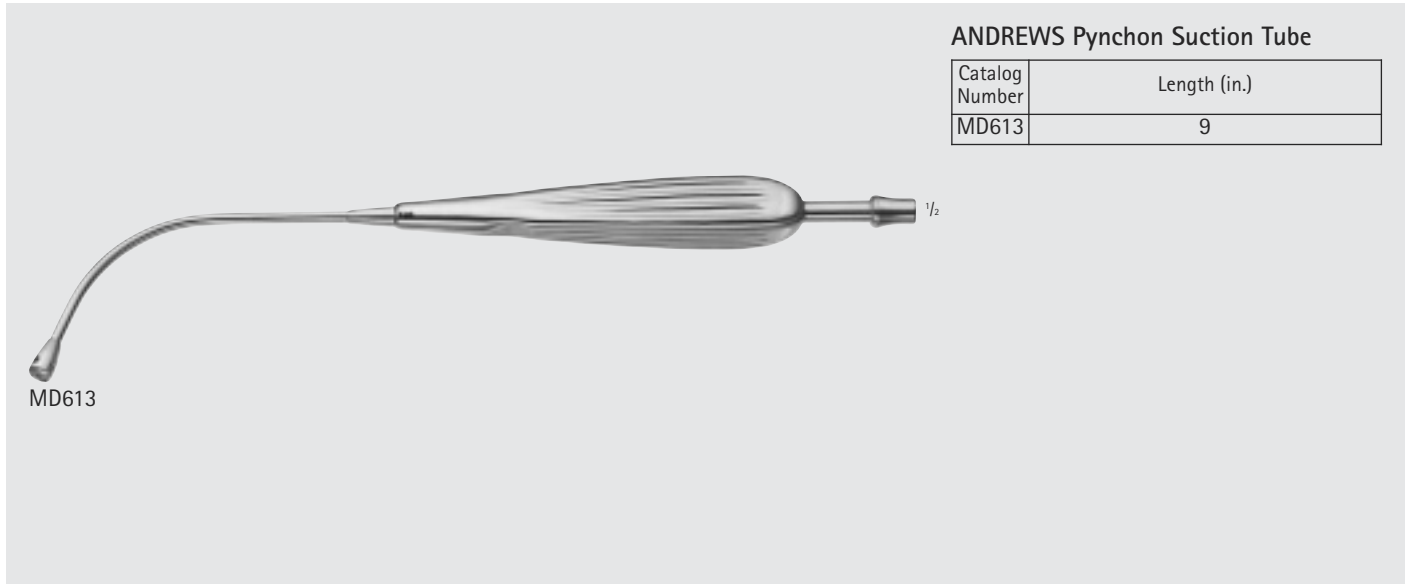
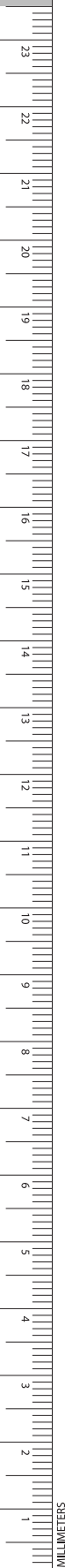

ANDREWS Pynchon Suction Tube

Catalog Number	Length (in.)
MD613	9

MD613

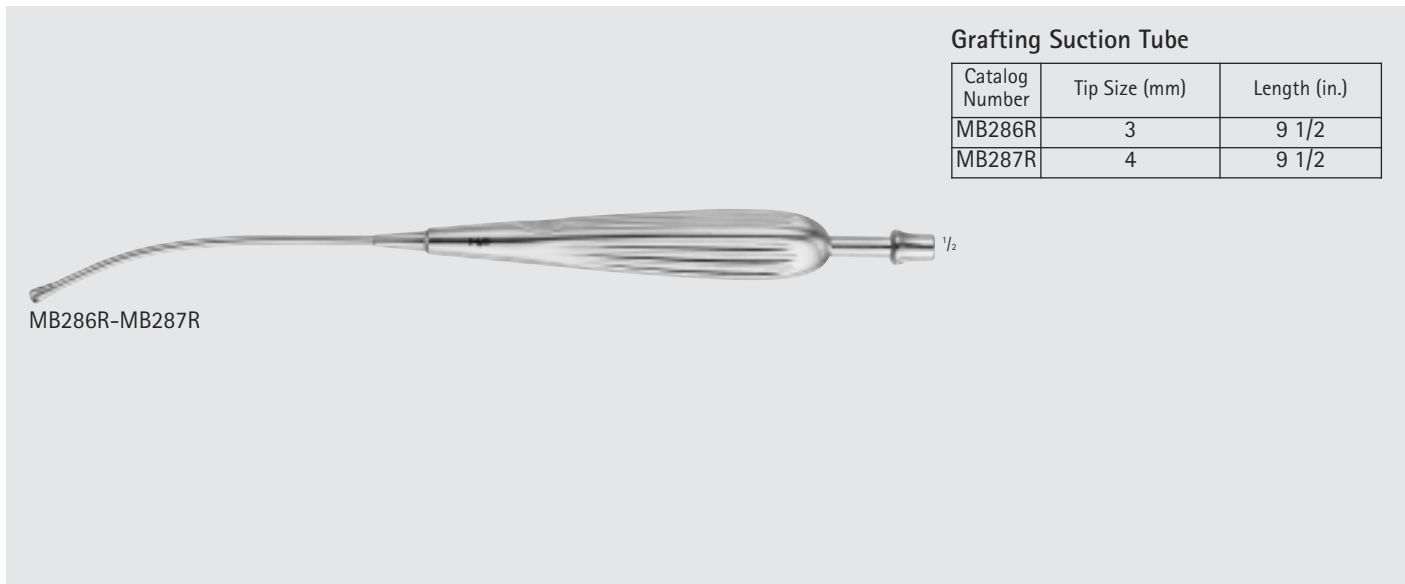

Grafting Suction Tube

Catalog Number	Tip Size (mm)	Length (in.)
MB286R	3	9 1/2
MB287R	4	9 1/2

MB286R-MB287R

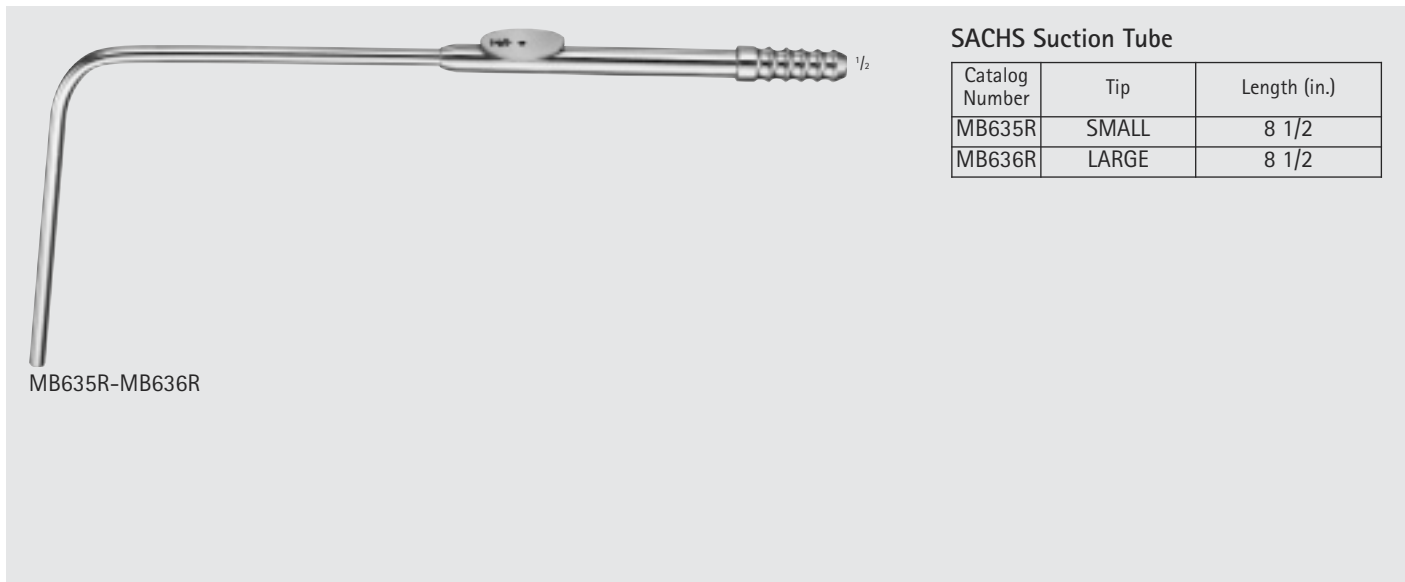

SACHS Suction Tube

Catalog Number	Tip	Length (in.)
MB635R	SMALL	8 1/2
MB636R	LARGE	8 1/2

MB635R-MB636R

YANKAUER Suction Tube

Catalog Number	Length (in.)
MB051R	14



MB051R

Suction Handle W/Thumb Control

Catalog Number	Length (in.)
MB052R	6 7/8



MB052R

YANKAUER Suction Tube, Chrome Plated

Catalog Number	Length (in.)
MB053R	6 5/8



MB053R

Atraumatic Suction Tube

Catalog Number	Tip	Tip Size (FR)	Length (in.)
MF106R	90° DOWN	5	8 1/2
MF107R	90° DOWN	7	8 1/2
MF108R	90° DOWN	10	8 1/2
MF109R	90° UP	5	8 1/2
MF110R	90° UP	7	8 1/2
MF111R	90° UP	10	8 1/2



MF106R-MF111R

General Surgery

Vessel Instruments



FB030R-FB040R

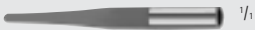

FB033



FB034R



FB035R



FB036R



FB037R



FB038R

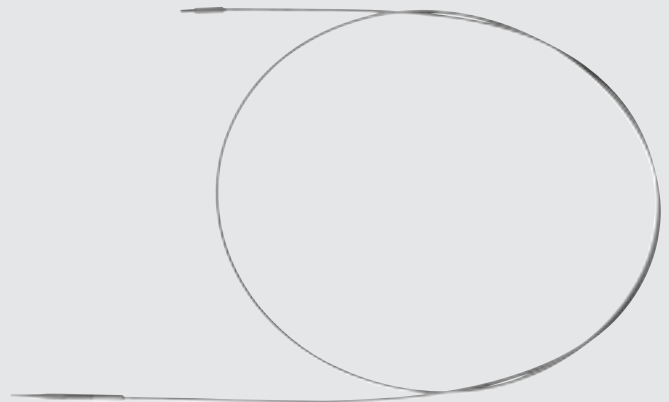

FB032R

NABATOFF Vein Stripper Set

Catalog Number	Item
FB030R	COMPLETE SET
FB031R	METAL CASE
FB032R	FLEXIBLE CABLE, 36"
FB033	PLASTIC PROBE TIP
FB034R	METAL PROBE TIP, 3MM
FB035R	METAL OLIVE, 6MM
FB036R	METAL OLIVE, 9MM
FB037R	METAL OLIVE, 12MM
FB038R	METAL OLIVE, 15MM
FB040R	HANDLE



FB031R-FB051R



FB053R



FB054R



FB055R

NABATOFF Mini Vain Stripper Set

Catalog Number	Item
FB031R	METAL CASE
FB051R	FLEXIBLE CABLE, 17 1/2"
FB053R	METAL OLIVE, 3MM
FB054R	METAL OLIVE, 4MM
FB055R	METAL OLIVE, 5MM

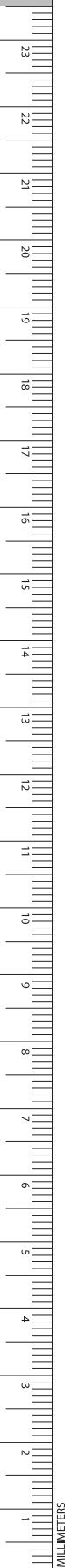



FB120R

VARADY Varix Dissector

Catalog Number	Length (in.)
FB120R	7



FB121R

VARADY Varix Extractor, W/Hook

Catalog Number	Length (in.)
FB121R	7



FB122R

VARADY Varix Extractor, W/Hook

Catalog Number	Length (in.)
FB122R	7



FB125R

VARADY Varix Extractor W/Hook

Catalog Number	Length (in.)
FB125R	6 3/4



FB126R

VARADY Mini-Varix Extractor W/Hook

Catalog Number	Length (in.)
FB126R	6 3/4



FB124R

VARADY Micro Spatula

Catalog Number	Length (in.)
FB124R	7



INCHES

General Surgery

Vessel Instruments



FB108R-FB117R



FB108R



FB109R



FB110R



FB112R



FB113R



FB114R



FB115R



FB116R



FB117R

Endarterectomy Stripper

Catalog Number	Tip Size (mm)	Length (in.)
FB108R	2	22
FB109R	3	22
FB110R	4	22
FB112R	6	22
FB113R	7	22
FB114R	8.5	22
FB115R	10	22
FB116R	12	22
FB117R	14	22



FB119R

Handle, F/FB108R-FB117R

Catalog Number	Length (in.)
FB119R	4 3/8

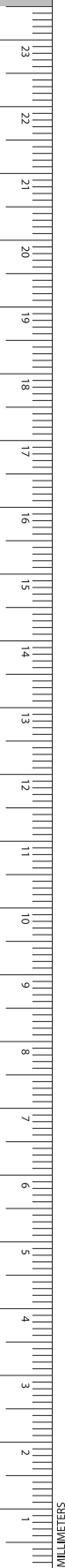



AA804R-AA806R

Steel Ruler, Graduated In Millimeters and Inches

Catalog Number	Length (in.)
AA804R	6
AA805R	12
AA806R	20

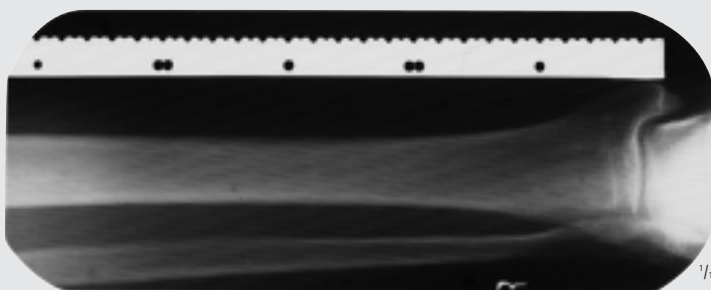

AA808R

Ruler, F/X-Ray Work

Catalog Number	Length (in.)
AA808R	20

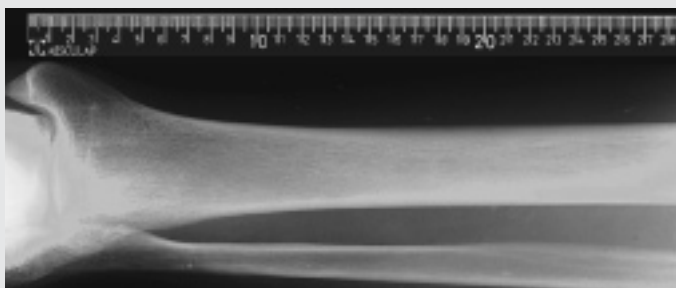

AA809

Plastic Ruler for F/X-Ray Work

Catalog Number	Length (in.)
AA809	20

autoclavable up to
3 bar (143°C)



AA821C-AA822C

Steel Tape Measure, Graduated in Millimeters and Inches

Catalog Number	Length (in.)
AA821C	60
AA822C	80

General Surgery

Diagnostic Instruments & Accessories

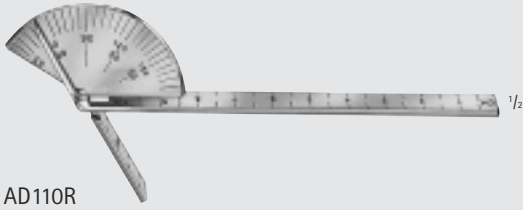

AD110R

Finger-Goniometer

Catalog Number
AD110R



AN379R-AN381R



AN379R



AN380R



AN381R

MAGILL Forceps

Catalog Number	Tip	Length (in.)
AN379R	INFANT	6
AN380R	PEDIATRIC	8
AN381R	ADULT	10

YOUNG Tongue Forceps

Catalog Number	Item	Length (in.)
AN705R	-	6 1/2
AN706	SPARE RUBBER	

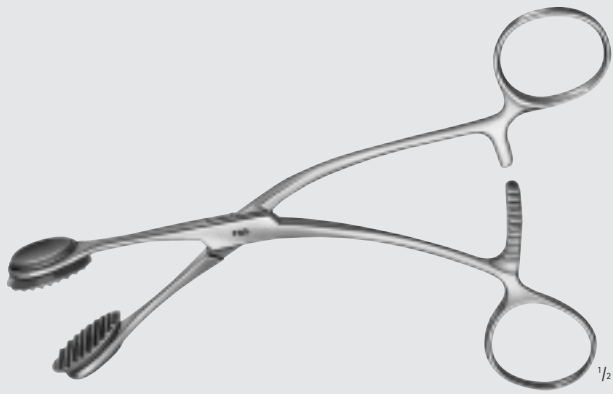

AN705R

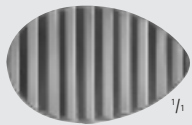

AN706

COLLIN Tongue Forceps

Catalog Number	Jaw	Length (in.)
BH906R	OVAL	6 1/4



BH906R



General Surgery

Tongue Forceps

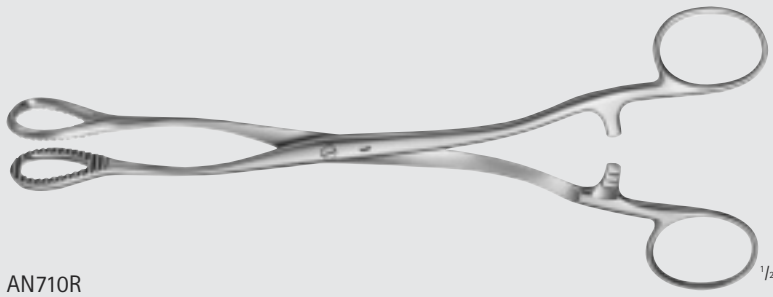

AN710R

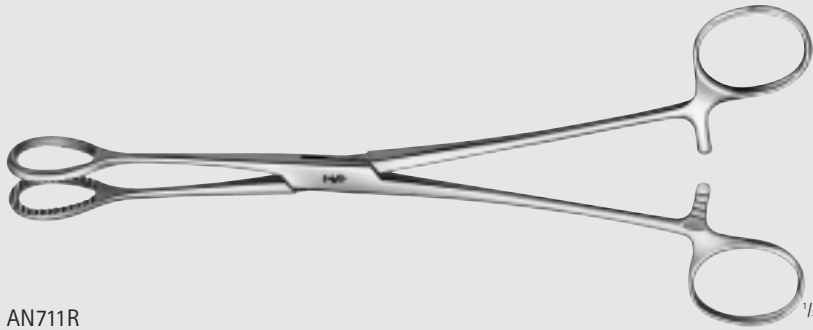

AN711R

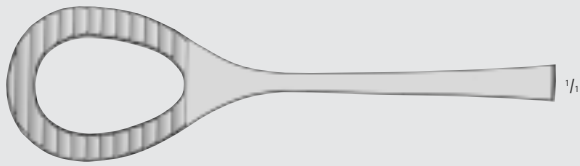

HEYWOOD-SMITH Tongue Forceps

Catalog Number	Length (in.)
AN710R	8
AN711R	8 1/2

Metal Sponge Bowl

Catalog Number	Capacity (qts.)
US060	1 1/2
US061	1
US062	1 7/8



US060-US062

Metal Cup

Catalog Number	Item	Capacity (oz.)
US063	IODINE CUP	6
US064	GRADUATED MEASURE	32
US065	IODINE CUP	14
US066	MEDICINE CUP	2
US067	SOLUTION BASIN	12



US063

Kidney Tray

Catalog Number	Length (in.)
JG504R	6 3/4
JG506R	10



JG504R-JG506R



INCHES

