



AESCULAP Aicon™

Sterile Container System

OPERATE WITH GREATER PRECISION



AESCULAP®

AESCULAP Aicon™

Sterile Container System

At **\$60/minute**,¹
any delay in the Operating Room can have a great impact.

Reduce the risk of Operating Room surgical delays due to unready sets.

The AESCULAP Aicon
Sterile Container System delivers:



100% Container
and Basket
Synchronization



47% Less
Dry Time²

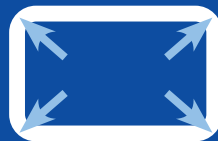

Up to 200%
Increase in Sterile
Aseptic Area³



Key Advantages

STREAMLINE PROCESSES

- Reduce process times throughout the reprocessing cycle (drying time, handling, sterilization, packaging, cleaning)
- Optimize processes in the Sterile Processing Department and Operating Room

IMPROVE COMMUNICATION

- Improve communication between Sterile Processing Department and Operating Room
- Easier set identification

INCREASE CONFIDENCE

- Safe transportation of sterile and contaminated goods
- Improve sterile presentation technique
- Reduce possibility of wet sets

1 www.accessefm.com/blog/the-cost-of-a-lost-minute-in-the-or

2 With AESCULAP Aicon EDS models. Data on file.

3 Data on file.

AESCULAP Aicon™

Sterile Container System

USER-FRIENDLY CLOSURE SYSTEM

Single-motion latch with large lifting handle improves lid handling during aseptic presentation.

STERILE SET SECURITY

Tamper-evident lock is visible from the front and top of the container and lays flat to protect it during transportation and handling.

EASY ACCESS TO INFORMATION

QR code provides product information and Instructions for Use (IFU) by simply scanning the code with a mobile device camera.

IMPROVED SET IDENTIFICATION

Interchangeable color faceplates and tags allow for more than 100 set identification options to easily identify specialties. Retaining brackets secure additional information.

ERGONOMIC CONTAINER HANDLING

Integrated handle evenly distributes weight through whole hand reducing fatigue and provides greater access to rear handle during lifting.

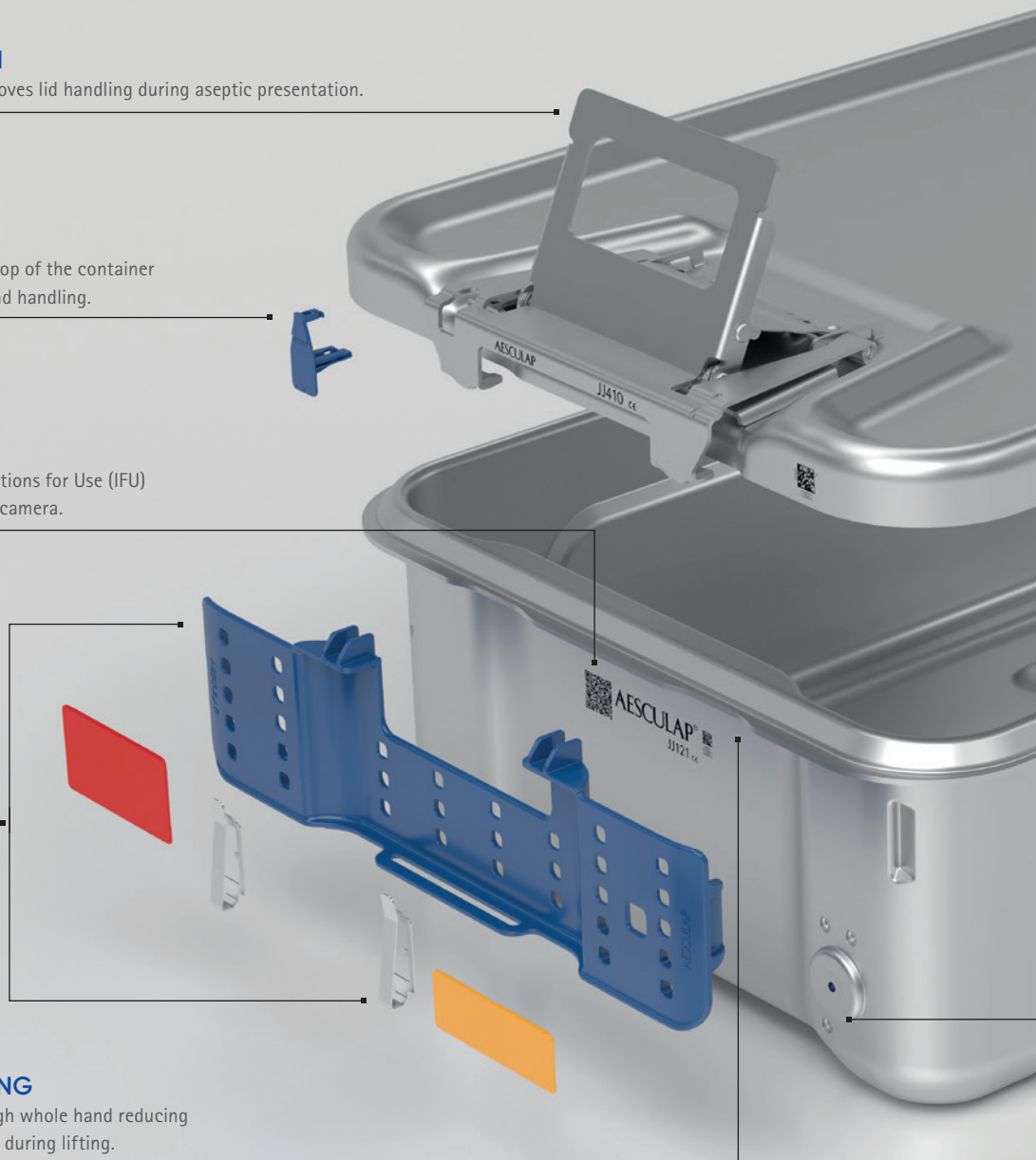



reddot winner 2020

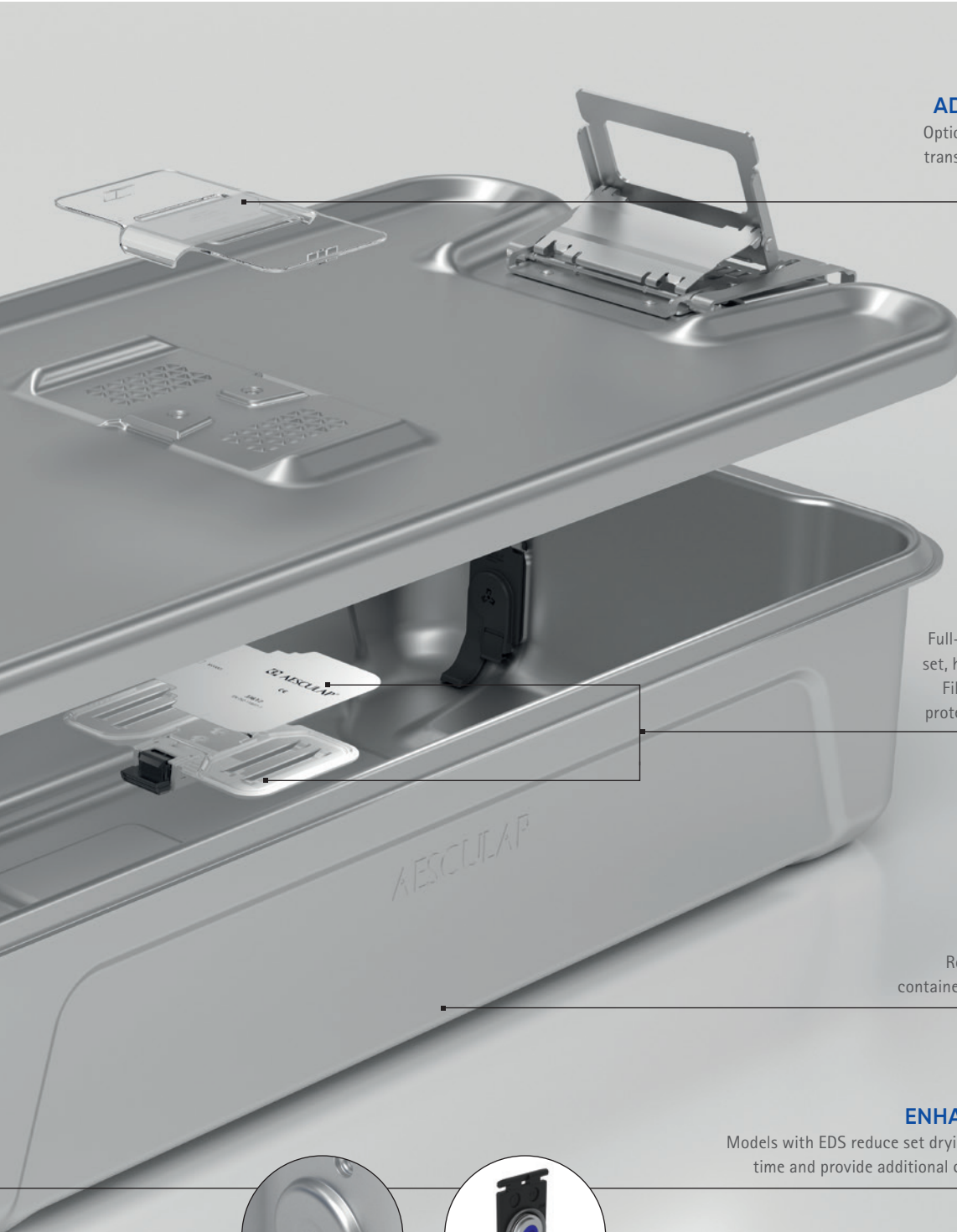

ADDED STERILITY PROTECTION

Optional cover adds additional protection when transporting between facilities and may remain in place during cleaning and sterilization.

REDUCED PROCESSING SUPPLIES

Full-sized container only requires one filter per set, helping reduce processing supply expenses. Filter retention plate holds filter in place and protects filter from damage and strike through.

LONGER SERVICE LIFE

Robust container and gasket design extends container life and delivers consistent performance.

ENHANCED DRYING SYSTEM (EDS)

Models with EDS reduce set drying times, decrease overall set reprocessing time and provide additional confidence of delivering dry sets to the OR.

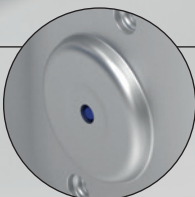

AESCULAP Aicon™

Sterile Container System

INSTRUMENT SECURITY

Non-slipping wavelike basket bottom holds instruments in place. Ring instruments stay upright during the packaging and transportation process to protect instruments and make them more accessible.

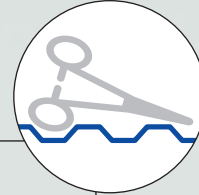

ADDED PROTECTION

Optional basket lid provides additional protection of set contents.

ERGONOMIC BASKET HANDLING

Large handles improve user control in the Sterile Processing Department and during aseptic presentation in the Operating Room.

QUICK SET IDENTIFICATION

Numerous tag options allow for easy set labeling and quick set identification.

BASKET FLEXIBILITY

Smooth and rounded design allows basket to be used with containers or single-use wrap.

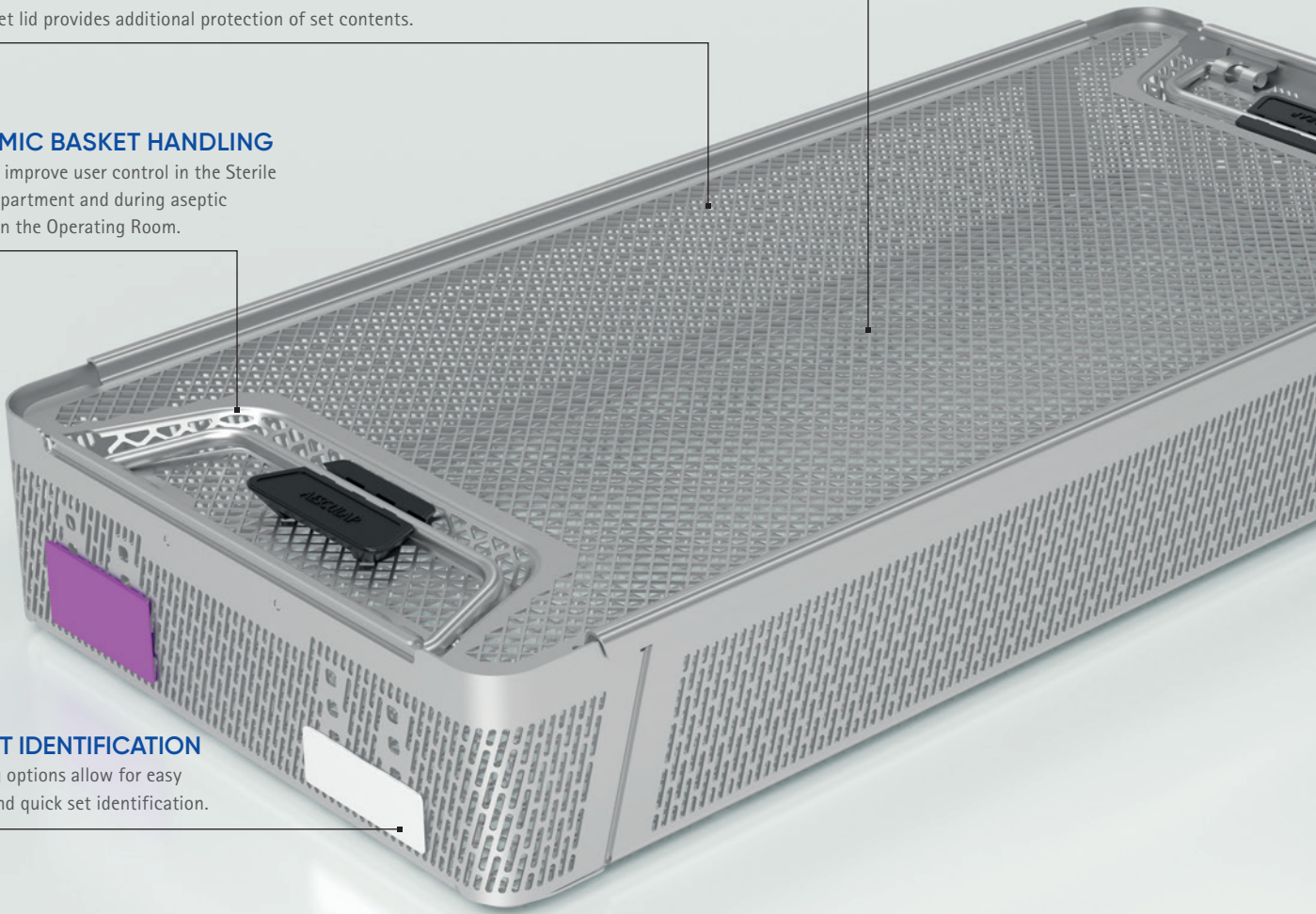



BASKET AND CONTAINER SYNCHRONIZATION

Enables identical tags to be used on the basket and removable container faceplate to streamline the reprocessing cycle and improve set identification.

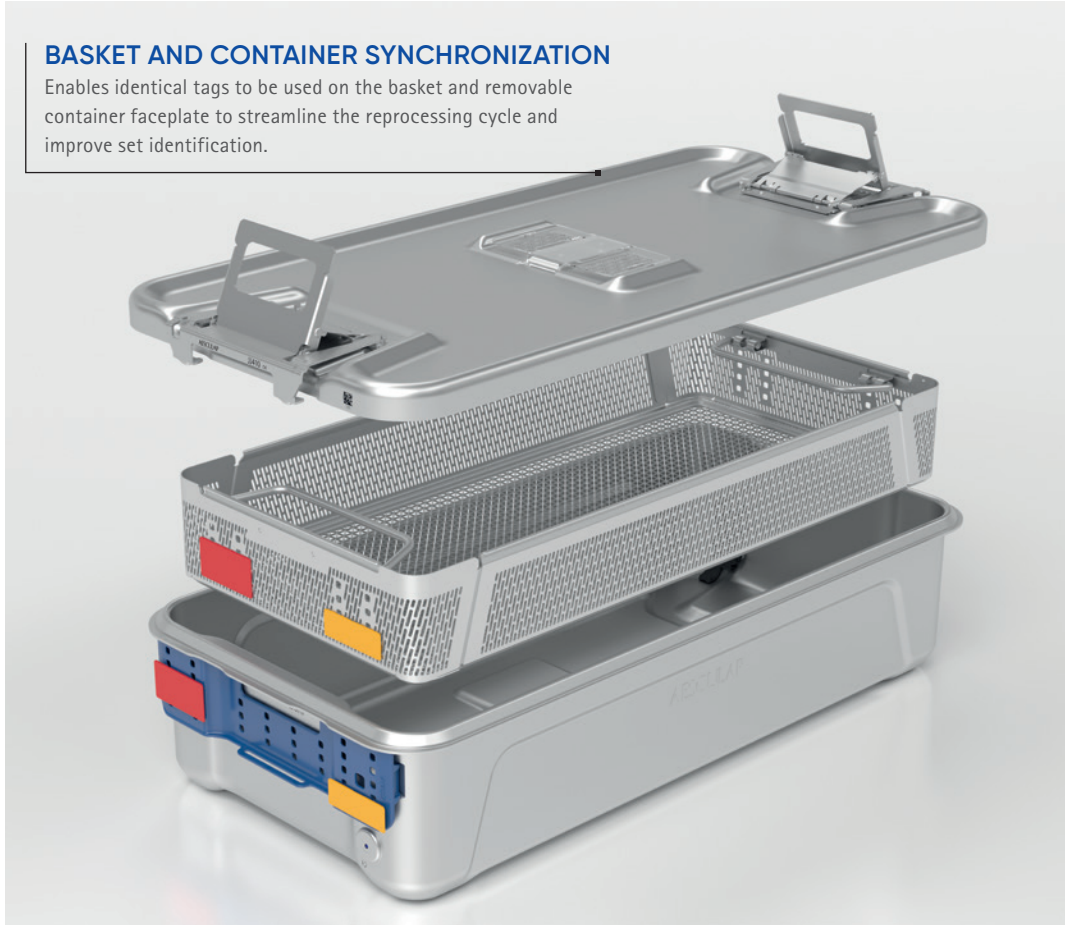

SPACE-SAVING BASKET DESIGN

Baskets nest together securely, with or without basket lid, to allow stacking in containers and during storage.

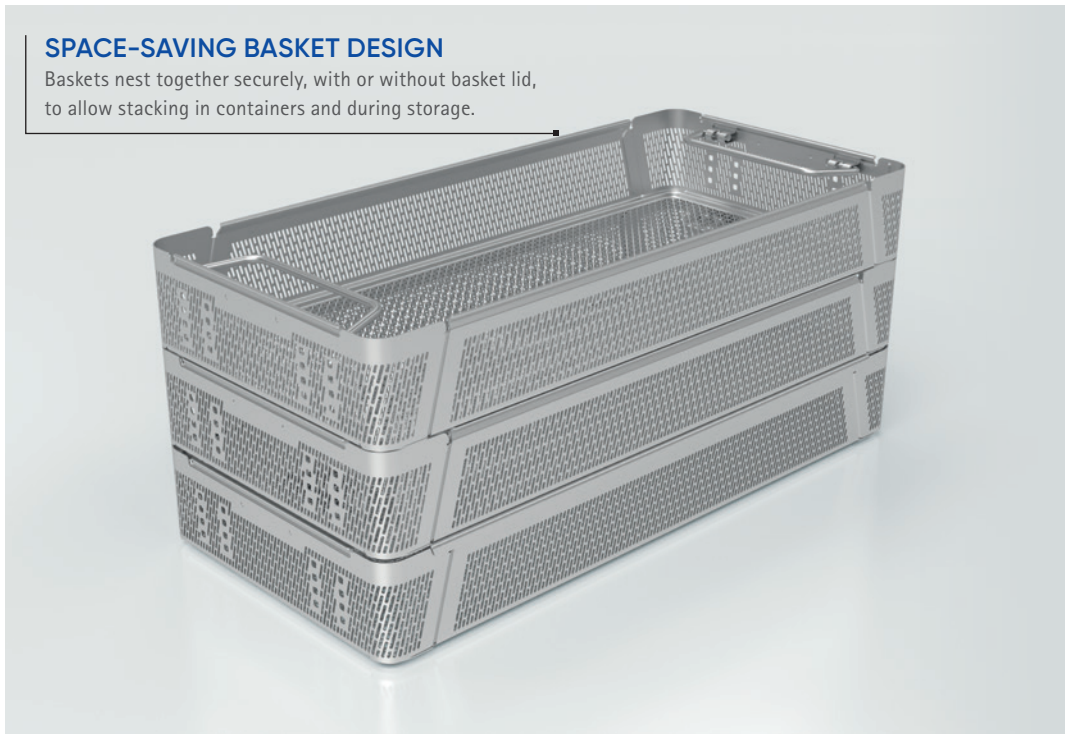

AESCULAP Aicon™

Sterile Container System Sizes 1/1

CONTAINER BOTTOMS

Item no.	Length 23 ⁵ / ₈ in 598 mm	Width 11 ³ / ₄ in 297 mm	Height ¹
JJ110			4 in 100 mm
JJ120			6 in 150 mm
JJ130			8 in 200 mm
JJ140			10 in 250 mm

CONTAINER BOTTOMS WITH ENHANCED DRYING SYSTEM (EDS)



Item no.	Length 23 ⁵ / ₈ in 598 mm	Width 11 ³ / ₄ in 297 mm	Height ¹
JJ111			4 in 100 mm
JJ121			6 in 150 mm
JJ131			8 in 200 mm
JJ141			10 in 250 mm

LIDS FIT ALL 1/1 CONTAINER BOTTOMS

Item no.	Length 23 ⁵ / ₈ in 598 mm	Width 11 ³ / ₄ in 297 mm	Height
JJ410			1 ¹ / ₈ in 28 mm

¹ Height with lid. Inches rounded up to closest 1/8 inch. Detailed dimension on page 14-15.

AESCLAP Aicon™

Sterile Container System Basket Sizes 1/1

Container Size 1/1



BASKET COMBINATION OPTIONS

Item no. container bottom	Item no. baskets Size 1/1
JJ110 JJ111	
JJ120 JJ121	
JJ130 JJ131	
JJ140 JJ141	

Container bottom
 Basket
 Front view

BASKET SIZES 1/1

Item no.	Length 21¼ in 537 mm Width 10 in 250 mm	Height ¹
JJ161R	1/1 AESCLAP Aicon basket	1½ in 35 mm
JJ162R		2¼ in 55 mm
JJ163R		3¼ in 80 mm
JJ164R		4¼ in 105 mm
JJ167R		¾ in 18 mm

¹ Inches rounded up to closest 1/8 inch. Detailed dimension on page 14-15.

AESCULAP Aicon™

Sterile Container System Sizes 3/4

CONTAINER BOTTOMS

Item no.	Length 18 ³ / ₈ in 464 mm Width 11 ³ / ₄ in 297 mm	Height ¹
JJ310		4 in 100 mm
JJ320		6 in 150 mm
JJ330		8 in 200 mm
JJ340		10 in 250 mm

CONTAINER BOTTOMS WITH ENHANCED DRYING SYSTEM (EDS)



Item no.	Length 18 ³ / ₈ in 464 mm Width 11 ³ / ₄ in 297 mm	Height ¹
JJ311		4 in 100 mm
JJ321		6 in 150 mm
JJ331		8 in 200 mm
JJ341		10 in 250 mm

LIDS FIT ALL 3/4 CONTAINER BOTTOMS

Item no.	Length 18 ³ / ₈ in 464 mm Width 11 ³ / ₄ in 297 mm	Height
JJ430		1 ¹ / ₈ in 28 mm

¹ Height with lid. Inches rounded up to closest 1/8 inch. Detailed dimension on page 14-15.

AESCULAP Aicon™

Sterile Container System Basket Sizes 3/4

Container Size 3/4



BASKET COMBINATION OPTIONS

Item no. container bottoms	Item no. baskets Size 3/4
JJ310 JJ311	
JJ320 JJ321	
JJ330 JJ331	
JJ340 JJ341	

Container bottom
 Basket
 Front view

BASKET SIZES 3/4

Item no.	Length 15 ⁷ / ₈ in 403 mm Width 10 in 250 mm	Height ¹
JJ361R	3/4 AESCULAP Aicon basket	1 ¹ / ₂ in 35 mm
JJ362R		2 ¹ / ₄ in 55 mm
JJ363R		3 ¹ / ₄ in 80 mm
JJ364R		4 ¹ / ₄ in 105 mm
JJ367R		3/4 in 18 mm

¹ Inches rounded up to closest 1/8 inch. Detailed dimension on page 14-15.

AESCLAP Aicon™

Sterile Container System Sizes 1/2

CONTAINER BOTTOMS

Item no.	Length 11 ⁷ / ₈ in 300 mm Width 11 ³ / ₄ in 297 mm	Height ¹
JJ210		4 in 100 mm
JJ220		6 in 150 mm
JJ230		8 in 200 mm
JJ240		10 in 250 mm

CONTAINER BOTTOMS WITH ENHANCED DRYING SYSTEM (EDS)



Item no.	Length 11 ⁵ / ₈ in 297 mm Width 11 ³ / ₄ in 300 mm	Height ¹
JJ211		4 in 100 mm
JJ221		6 in 150 mm
JJ231		8 in 200 mm
JJ241		10 in 250 mm

LIDS FIT ALL 1/2 CONTAINER BOTTOMS

Item no.	Length 11 ⁷ / ₈ in 300 mm Width 11 ³ / ₄ in 297 mm	Height
JJ420		1 ¹ / ₈ in 28 mm

¹ Height with lid. Inches rounded up to closest 1/8 inch. Detailed dimension on page 14-15.

AESCULAP Aicon™

Sterile Container System Basket Sizes 1/2

BASKET COMBINATION OPTIONS



Item no. container bottoms	Item no. baskets Size 1/2
JJ210 JJ211	
JJ220 JJ221	
JJ230 JJ231	
JJ240 JJ241	

Container bottom
 Basket
 Front view





BASKET SIZES 1/2

Item no.	Length 9 1/2 in 240 mm Width 10 in 250 mm	Height ¹
JJ261R	1/2 AESCULAP Aicon basket	1 1/2 in 35 mm
JJ262R		2 1/4 in 55 mm
JJ263R		3 1/4 in 80 mm
JJ264R		4 1/4 in 105 mm
JJ267R		3/4 in 18 mm

¹ Inches rounded up to closest 1/8 inch. Detailed dimension on page 14-15.

AESCULAP Aicon™

Sterile Container System Identification Faceplates and Tags

Color	Faceplate		Tag	
	1/pk	10/pk	Large, 1/pk	Small, 1/pk
Red 	JJ500	JJ520	JJ540U	JJ560U
Blue 	JJ501	JJ521	JJ541U	JJ561U
Green 	JJ502	JJ522	JJ542U	JJ562U
Yellow 	JJ503	JJ523	JJ543U	JJ563U
Gray 	JJ504	JJ524	JJ544U	JJ564U
Black 	JJ505	JJ525	-	-
White 	JJ506	JJ526	JJ546U	JJ566U
Orange 	JJ507	JJ527	JJ547U	JJ567U
Violet 	JJ508	JJ528	JJ548U	JJ568U
Brown 	JJ509	JJ529	JJ549U	JJ569U
Size	9 ⁷ / ₈ x 2 ³ / ₄ in 248 x 70 mm		2 ¹ / ₄ x 1 ¹ / ₄ in 56 x 29 mm	2 ¹ / ₄ x ³ / ₄ in 56 x 19 mm

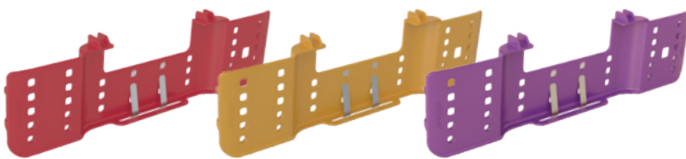

Faceplates



Large Tags
2¹/₄ x 1¹/₄ in
56 x 29 mm



Small Tags
2¹/₄ x ³/₄ in
56 x 19 mm

ALL-IN-ONE LABELS

Item no. 1000 units	Without indicator
JJ754	Core-D: 40 mm
JJ755	Core-D: 76 mm

AESCULAP Aicon™

Sterile Container System Processing Supplies and Accessories

SINGLE-USE PAPER FILTER

Item no. 100/pk	Without indicator
JJ612	



RETENTION PLATE

Item no. 1/pk	
JJ600	

COVER FOR PERFORATED AREA

Item no. 1/pk	Item no. 10/pk	
JJ440	JJ441	

CONTAINER LOCK

Item no. 100/pk	Item no. 1000/pk	Blue, without indicator
JJ705	JJ700	
Item no. 100/pk	Item no. 1000/pk	Orange, with steam indicator
JJ725	JJ720	
Item no. 100/pk	Item no. 1000/pk	Yellow, with steam indicator
JJ726	JJ721	

RETAINING BRACKET FOR FACEPLATE

Item no. 10/pk	
JJ599	

ENHANCED DRYING SYSTEM (EDS) MODULE

Item no. 1/pk	
JJ800	

LABEL ADAPTER FOR FACEPLATE

Item no. 1/pk	3 1/4 x 1 1/2 in 80 x 35 mm
JJ582	

AESCLAP Aicon™

Sterile Container System Dimensions

TABLE OF DIMENSIONS FOR STERILE CONTAINERS SIZE 1/1 WITH AND WITHOUT ENHANCED DRYING SYSTEM (EDS)¹





Item no.	Lid - outer dimensions (LxWxH)	Sterile container bottom - outer dimensions (LxWxH)	Sterile container bottom - inner dimensions [LxWxH] (loading height)	Sterile container with lid - outer dimensions (LxWxH)
Lid				
JJ410	23 ⁵ / ₈ x 11 ³ / ₄ x 1 ¹ / ₈ in 598 x 297 x 28 mm			
Sterile container bottom				
JJ110 JJ111		23 ⁵ / ₈ x 11 ³ / ₄ x 3 ¹ / ₂ in 598 x 297 x 86 mm	21 ⁵ / ₈ x 10 ¹ / ₄ x 2 ⁵ / ₈ in 548 x 258 x 64 mm	23 ⁵ / ₈ x 11 ³ / ₄ x 4 in 598 x 297 x 100 mm
JJ120 JJ121		23 ⁵ / ₈ x 11 ³ / ₄ x 5 ³ / ₈ in 598 x 297 x 136 mm	21 ⁵ / ₈ x 10 ¹ / ₄ x 4 ¹ / ₂ in 548 x 258 x 114 mm	23 ⁵ / ₈ x 11 ³ / ₄ x 6 in 598 x 297 x 150 mm
JJ130 JJ131		23 ⁵ / ₈ x 11 ³ / ₄ x 7 ³ / ₈ in 598 x 297 x 186 mm	21 ⁵ / ₈ x 10 ¹ / ₄ x 6 ¹ / ₂ in 548 x 258 x 164 mm	23 ⁵ / ₈ x 11 ³ / ₄ x 8 in 598 x 297 x 200 mm
JJ140 JJ141		23 ⁵ / ₈ x 11 ³ / ₄ x 9 ³ / ₈ in 598 x 297 x 236 mm	21 ⁵ / ₈ x 10 ¹ / ₄ x 8 ¹ / ₂ in 548 x 258 x 214 mm	23 ⁵ / ₈ x 11 ³ / ₄ x 10 in 598 x 297 x 250 mm

TABLE OF DIMENSIONS FOR STERILE CONTAINERS SIZE 3/4 WITH AND WITHOUT ENHANCED DRYING SYSTEM (EDS)¹

Item no.	Lid - outer dimensions (LxWxH)	Sterile container bottom - outer dimensions (LxWxH)	Sterile container bottom - inner dimensions [LxWxH] (loading height)	Sterile container with lid - outer dimensions (LxWxH)
Lid				
JJ430	18 ³ / ₈ x 11 ³ / ₄ x 1 ¹ / ₈ in 464 x 297 x 28 mm			
Sterile container bottom				
JJ310 JJ311		18 ³ / ₈ x 11 ³ / ₄ x 3 ¹ / ₂ in 464 x 297 x 86 mm	16 ³ / ₈ x 10 ¹ / ₄ x 2 ⁵ / ₈ in 414 x 258 x 64 mm	18 ³ / ₈ x 11 ³ / ₄ x 4 in 464 x 297 x 100 mm
JJ320 JJ321		18 ³ / ₈ x 11 ³ / ₄ x 5 ³ / ₈ in 464 x 297 x 136 mm	16 ³ / ₈ x 10 ¹ / ₄ x 4 ¹ / ₂ in 414 x 258 x 114 mm	18 ³ / ₈ x 11 ³ / ₄ x 6 in 464 x 297 x 150 mm
JJ330 JJ331		18 ³ / ₈ x 11 ³ / ₄ x 7 ³ / ₈ in 464 x 297 x 186 mm	16 ³ / ₈ x 10 ¹ / ₄ x 6 ¹ / ₂ in 414 x 258 x 164 mm	18 ³ / ₈ x 11 ³ / ₄ x 8 in 464 x 297 x 200 mm
JJ340 JJ341		18 ³ / ₈ x 11 ³ / ₄ x 9 ³ / ₈ in 464 x 297 x 236 mm	16 ³ / ₈ x 10 ¹ / ₄ x 8 ¹ / ₂ in 414 x 258 x 214 mm	18 ³ / ₈ x 11 ³ / ₄ x 10 in 464 x 297 x 250 mm

¹ Inches rounded up to closest 1/8 inch.

TABLE OF DIMENSIONS FOR STERILE CONTAINERS SIZE 1/2
WITH AND WITHOUT ENHANCED DRYING SYSTEM (EDS)¹

Item no.	Lid - outer dimensions (LxWxH) 	Sterile container bottom - outer dimensions (LxWxH) 	Sterile container bottom - inner dimensions [LxWxH] (loading height) 	Sterile container with lid - outer dimensions (LxWxH) 
Lid				
JJ420	11⁷/₈ x 11³/₄ x 1¹/₈ in 300 x 297 x 28 mm			
Sterile container bottom				
JJ210 JJ211		11 ⁷ / ₈ x 11 ³ / ₄ x 3¹/₂ in 300 x 297 x 86 mm	10 x 10 ¹ / ₈ x 2⁵/₈ in 250 x 258 x 64 mm	11 ⁷ / ₈ x 11 ³ / ₄ x 4 in 300 x 297 x 100 mm
JJ220 JJ221		11 ⁷ / ₈ x 11 ³ / ₄ x 5³/₈ in 300 x 297 x 136 mm	10 x 10 ¹ / ₈ x 4¹/₂ in 250 x 258 x 114 mm	11 ⁷ / ₈ x 11 ³ / ₄ x 6 in 300 x 297 x 150 mm
JJ230 JJ231		11 ⁷ / ₈ x 11 ³ / ₄ x 7³/₈ in 300 x 297 x 186 mm	10 x 10 ¹ / ₈ x 6¹/₂ in 250 x 258 x 164 mm	11 ⁷ / ₈ x 11 ³ / ₄ x 8 in 300 x 297 x 200 mm
JJ240 JJ241		11 ⁷ / ₈ x 11 ³ / ₄ x 9³/₈ in 300 x 297 x 236 mm	10 x 10 ¹ / ₈ x 8¹/₂ in 250 x 258 x 214 mm	11 ⁷ / ₈ x 11 ³ / ₄ x 10 in 300 x 297 x 250 mm

The AESCULAP Aicon™ Sterile Container System Instructions for Use are published on <http://www.aesculapusaius.com/>

NOTES:

¹Inches rounded up to closest 1/8 inch.

AESULAP Aicon™

Sterile Container System Basket Dimensions

TABLE OF DIMENSIONS FOR
BASKETS SIZE 1/1¹

Item no.	Basket lid outer dimensions (LxWxH)	Basket outer dimensions (LxWxH)	Basket inner dimensions (LxWxH)
Basket lid			
JJ167R	20 ⁷ / ₈ x 10 x ³ / ₄ in 528 x 253 x 18 mm		
Basket			
JJ161R		21 ¹ / ₄ x 10 x 1 ¹ / ₂ in 537 x 250 x 35 mm	21 ¹ / ₈ x 9 ⁷ / ₈ x 1 ³ / ₈ in 535 x 248 x 32 mm
JJ162R		21 ¹ / ₄ x 10 x 2 ¹ / ₄ in 537 x 250 x 55 mm	21 ¹ / ₈ x 9 ⁷ / ₈ x 2 ¹ / ₈ in 535 x 248 x 52 mm
JJ163R		21 ¹ / ₄ x 10 x 3 ¹ / ₄ in 537 x 250 x 80 mm	21 ¹ / ₈ x 9 ⁷ / ₈ x 3 ¹ / ₈ in 535 x 248 x 77 mm
JJ164R		21 ¹ / ₄ x 10 x 4 ¹ / ₄ in 537 x 250 x 105 mm	21 ¹ / ₈ x 9 ⁷ / ₈ x 4 ¹ / ₈ in 535 x 248 x 102 mm

TABLE OF DIMENSIONS FOR
BASKETS SIZE 3/4¹

Item no.	Basket lid outer dimensions (LxWxH)	Basket outer dimensions (LxWxH)	Basket inner dimensions (LxWxH)
Basket lid			
JJ367R	15 ⁵ / ₈ x 10 x ³ / ₄ in 394 x 253 x 18 mm		
Basket			
JJ361R		15 ⁵ / ₈ x 10 x 1 ¹ / ₂ in 403 x 250 x 35 mm	15 ⁷ / ₈ x 10 x 1 ³ / ₈ in 401 x 248 x 32 mm
JJ362R		15 ⁵ / ₈ x 10 x 2 ¹ / ₄ in 403 x 250 x 55 mm	15 ⁷ / ₈ x 10 x 2 ¹ / ₈ in 401 x 248 x 52 mm
JJ363R		15 ⁵ / ₈ x 10 x 3 ¹ / ₄ in 403 x 250 x 80 mm	15 ⁷ / ₈ x 10 x 3 ¹ / ₈ in 401 x 248 x 77 mm
JJ364R		15 ⁵ / ₈ x 10 x 4 ¹ / ₄ in 403 x 250 x 105 mm	15 ⁷ / ₈ x 10 x 4 ¹ / ₈ in 401 x 248 x 102 mm

¹ Inches rounded up to closest 1/8 inch.

TABLE OF DIMENSIONS FOR BASKETS SIZE 1/2¹

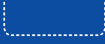
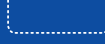
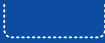
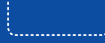
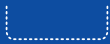
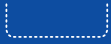
Item no.	Basket lid outer dimensions (LxWxH)	Basket outer dimensions (LxWxH)	Basket inner dimensions (LxWxH)
Basket lid			
JJ267R	9 ¹ / ₈ x 10 x 3 ³ / ₄ in 231 x 253 x 18 mm		
Basket			
JJ261R		9 ¹ / ₂ x 10 x 1 ¹ / ₂ in 240 x 250 x 35 mm	9 ³ / ₈ x 9 ⁷ / ₈ x 1 ³ / ₈ in 238 x 248 x 32 mm
JJ262R		9 ¹ / ₂ x 10 x 2 ¹ / ₄ in 240 x 250 x 55 mm	9 ³ / ₈ x 9 ⁷ / ₈ x 2 ¹ / ₈ in 238 x 248 x 52 mm
JJ263R		9 ¹ / ₂ x 10 x 3 ¹ / ₄ in 240 x 250 x 80 mm	9 ³ / ₈ x 9 ⁷ / ₈ x 3 ¹ / ₈ in 238 x 248 x 77 mm
JJ264R		9 ¹ / ₂ x 10 x 4 ¹ / ₄ in 240 x 250 x 105 mm	9 ³ / ₈ x 9 ⁷ / ₈ x 4 ¹ / ₈ in 238 x 248 x 102 mm

NOTES:

¹Inches rounded up to closest 1/8 inch.



Through collaborative
excellence we will improve the
quality of a patient's life and
meet the needs of the changing
healthcare environment.

Technical alterations are possible. This leaflet may be used for no other purposes than offering, buying and selling of our products. No part may be copied or reproduced in any form. In the case of misuse we retain the rights to recall our catalogs and price lists and to take legal actions.

©2022 AESCULAP, INC. ALL RIGHTS RESERVED. PRINTED IN THE USA.
Aesculap is an equal opportunity employer

Aesculap, Inc. | 3773 Corporate Parkway | Center Valley, PA | 18034
Phone 800-282-9000 | Fax 610-791-6886 | www.aesculapusa.com

Aesculap, Inc. - a B. Braun company

DOC1681 Rev D 04/22

