



Sterile Container Systems

General Catalog

OPERATE WITH GREATER PRECISION™



AESCULAP®

Sterile Container Systems

General Catalog



Instructions For Use are located at
www.aesculapusaius.com



Instructional videos on processing the
Aesculap SterilContainer™ System are located at
www.youtube.com/user/aesculapusa

Table of Contents

Introduction	4-5
AESCU LAP Aicon® Sterile Container System Containers and Baskets.....	6-17
▪ AEscuLAP Aicon Sterile Container System Design	6-9
▪ Full Size.....	10-11
▪ Three-Quarter Size.....	12-13
▪ Half Size.....	14-15
▪ Identification Faceplates and Tags.....	16
▪ Processing Supplies and Accessories	17
SterilContainer® System Containers and Baskets	18-37
▪ SterilContainer Design, IUSS Validated	18-19
▪ Full Size.....	20-21
▪ Three-Quarter Size.....	22-23
▪ Half Size.....	24-25
▪ Extra-Long Mini Size.....	26
▪ Extra-Long Size.....	27
▪ Quarter Size, Bar Code ID Brackets for Baskets	28-29
▪ Mini Size	30
▪ Wide-Body Size.....	31
▪ JS Series S2 and JM SterilContainer™ S Container Systems	32-33
▪ Sterile Processing Supplies.....	34-36
▪ Identification Labels and Tags.....	37
Instrument Organization System	38-51
General Accessories.....	52-61
▪ Endoscopy Storage Accessories.....	52-53
▪ Instrument Storage Racks.....	54-55
▪ Basket Lid Instrument Support Holder.....	56
▪ Micro Instruments Holders and Racks	57
▪ Mats, Lubricants and Cleaners.....	58-59
▪ Communicator Tags, Stringers and ID Brackets	60
Storage and Transport	61
▪ Display Peg Boards and Instrument Holders	61
Miscellaneous.....	62-64
▪ Metal Basins and Bowls.....	62
▪ SterilContainer Replacement Parts.....	63
▪ BIO-BIN Containers.....	64
Sterile Container Product Dimensions.....	66-79
▪ AEscuLAP Aicon Sterile Container System	66-69
▪ SterilContainer System.....	70-79
Instructions For Use	80

Commitment to Quality



A Heritage of Quality for Over 150 Years



Gottfried Jetter

Aesculap, the world's largest manufacturer of surgical instruments, has been crafting high performance instruments in Tuttlingen, Germany since 1867. Named

for the Greek god of healing, Asklepios, the company was founded by Gottfried Jetter, the first person ever to produce standardized surgical instruments.

Today, Aesculap employs nearly 12,000 people in our modern, Aesculap-owned and operated factories around the world, including 3,500 people in the Tuttlingen facilities which house over 450,000 square feet of production area.

PERFORMANCE QUALITY Surgical Instruments Made by Aesculap

For every surgical instrument *Made by Aesculap* we demand not just "Quality", but *PERFORMANCE QUALITY*. A surgical instrument with *PERFORMANCE QUALITY* is meticulously crafted to have a solid feel and to perform like an extension of the surgeon's own hand. To deliver *PERFORMANCE QUALITY* worthy of the Aesculap name, we start with the finest, raw materials including highly pure stainless steel which is purchased and tested in Tuttlingen. Our master craftsmen, who are among the most rigorously trained and experienced in the industry, then follow the strictest standards when crafting each instrument, including:

- **State-of-the-art German-made equipment** which is used in every Aesculap-owned factory worldwide
- **Aesculap hand-crafted, Gold-Plated Master QC Standards** that assure pattern consistency
- **Strict Aesculap manufacturing guidelines**, including tight tolerances more strict than International Quality Standards, for precision and reliability from first use and throughout the lifetime of each instrument

As our Mission states, we are "passionately committed to providing high quality, innovative products and services to all surgical disciplines."

Aesculap Product Range:

- Surgical instruments for all disciplines
- Sterile containers
- Endoscopy
- Neuroendoscopy
- Aneurysm clips
- Power systems
- Pneumatic KAIRison® Bone Punches
- Orthopaedics
- Per-procedure programs
- Repair services
- Consulting services
- Dura substitutes
- Hydrocephalus

Aesculap U.S. Headquarters



Aesculap U.S. Headquarters

Our U.S. Headquarters, located in Center Valley, Pennsylvania, was established in 1977 to serve the needs of the U.S. market.

Should you have any need or questions, our customer service professionals welcome your call.

Aesculap holds customers and patients to the highest level in our core values. Our commitment is to exceed your expectations.

Aesculap, Inc.
3773 Corporate Parkway
Center Valley, PA 18034
Phone 800-258-1946
Fax 610-791-6880
www.aesculapusa.com

Please Call Customer Service For:

- Placing orders
- Product information
- Pricing

Customer Service:

Phone: **800-282-9000**

Fax: **610-791-6886**

AESCLAP Aicon®

Sterile Container System

USER-FRIENDLY CLOSURE SYSTEM

Single-motion latch with large lifting handle designed to improve lid handling during aseptic presentation.

STERILE SET SECURITY

Tamper-evident lock is visible from the front and top of the container and lays flat to protect it during transportation and handling.

EASY ACCESS TO INFORMATION

QR code provides product information and Instructions for Use (IFU) by simply scanning the code with a mobile device camera.

IMPROVED SET IDENTIFICATION

Interchangeable color faceplates and tags allow for more than 100 set identification options designed to easily identify specialties. Retaining brackets secure additional information.

ERGONOMIC CONTAINER HANDLING

Integrated handle evenly distributes weight through whole hand to help reduce fatigue and designed for greater access to rear handle during lifting.

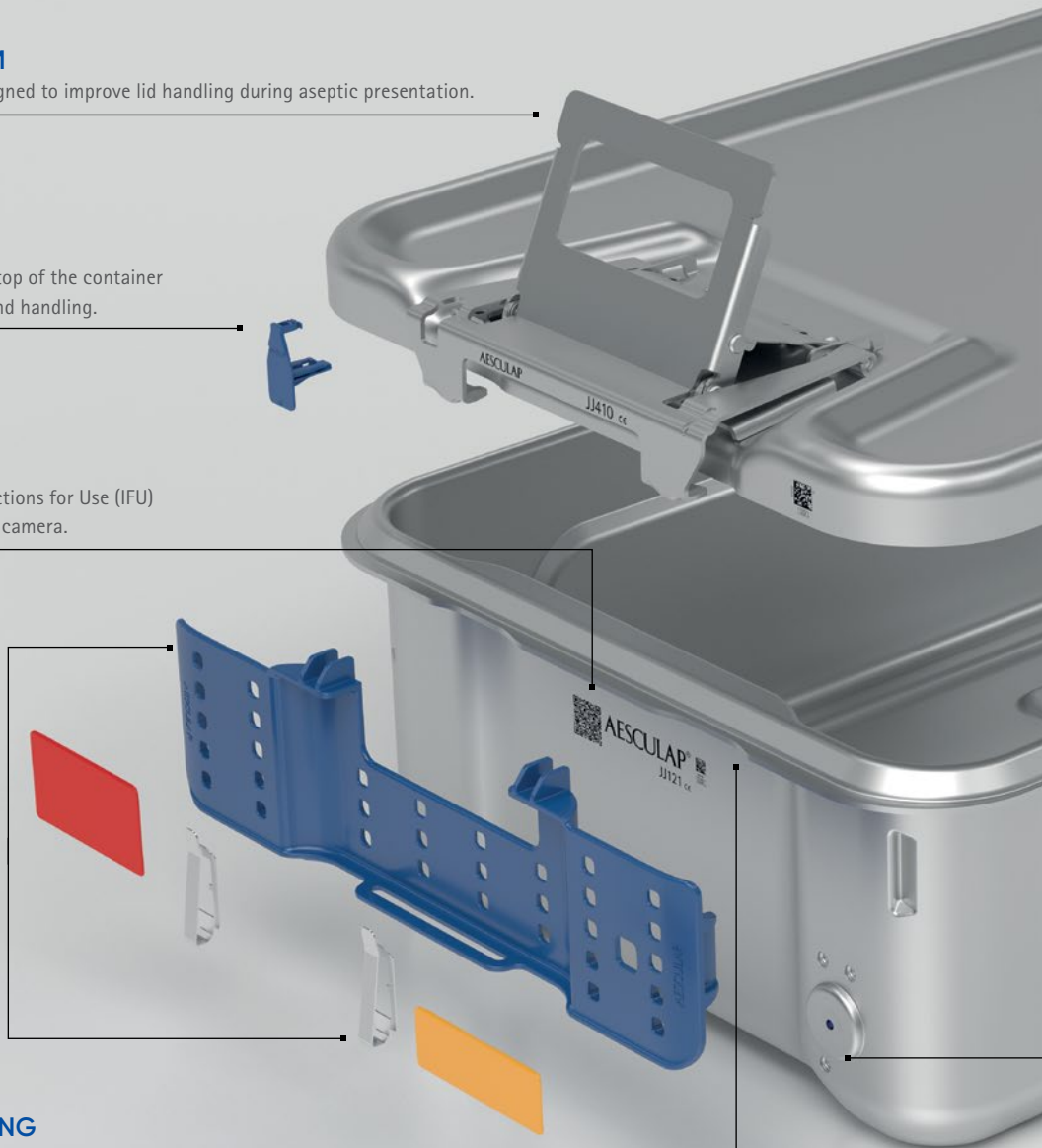



reddot winner 2020

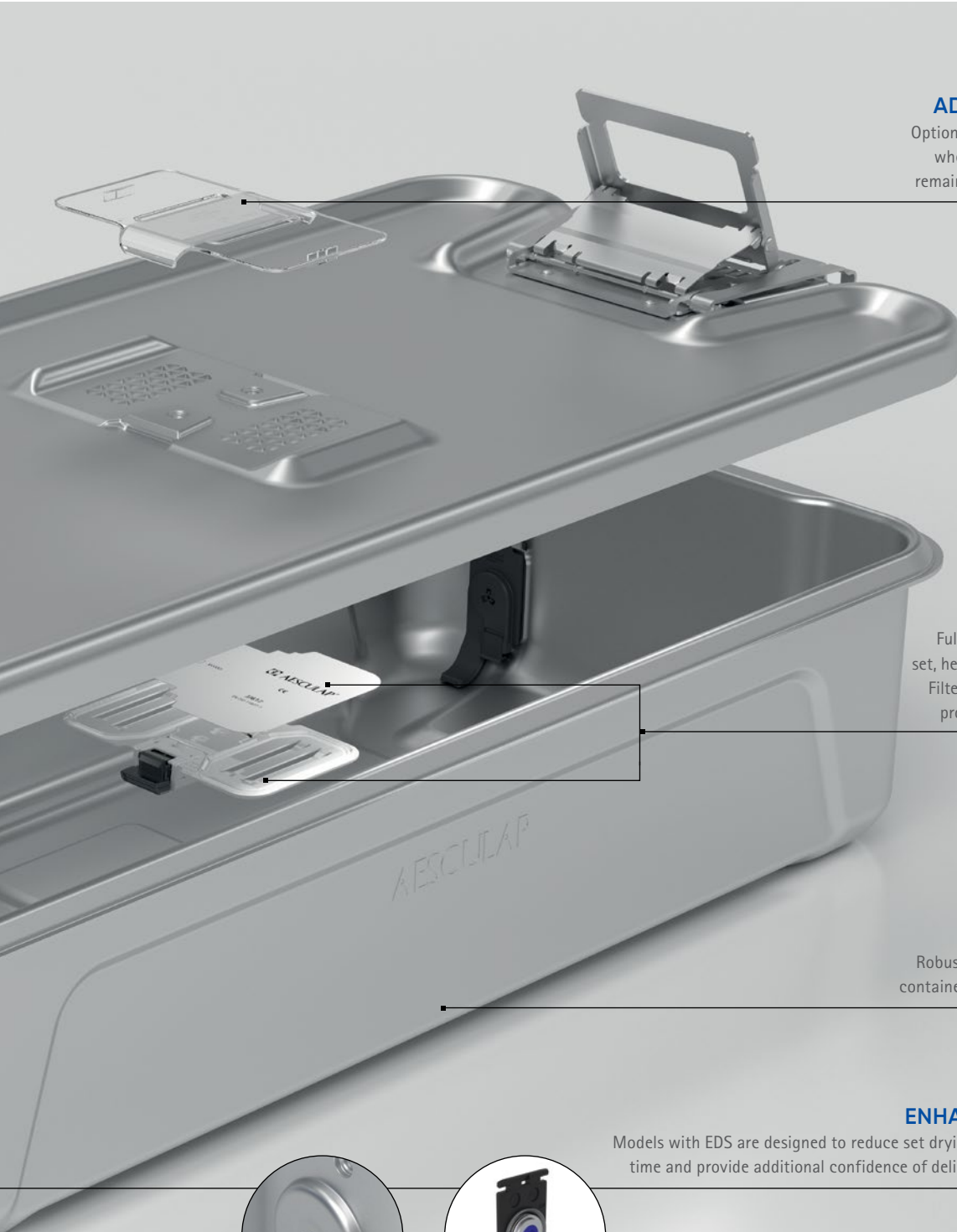

ADDED STERILITY PROTECTION

Optional cover designed for additional protection when transporting between facilities and may remain in place during cleaning and sterilization.

REDUCED PROCESSING SUPPLIES

Full-sized container only requires one filter per set, helping to reduce processing supply expenses. Filter retention plate holds filter in place to help protect filter from damage and strike through.

LONGER SERVICE LIFE

Robust container and gasket designed to extend container life and provide consistent performance.

ENHANCED DRYING SYSTEM (EDS)

Models with EDS are designed to reduce set drying times, decrease overall set reprocessing time and provide additional confidence of delivering dry sets to the operating room (OR).

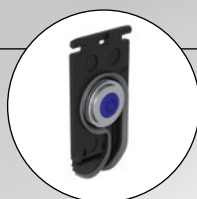
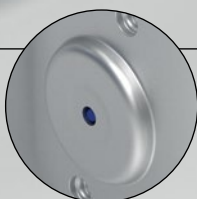

AESCULAP Aicon®

Sterile Container System

INSTRUMENT SECURITY

Non-slipping wavelike basket bottom designed to hold instruments in place. Ring instruments stay upright during the packaging and transportation process to help protect instruments and make them more accessible.

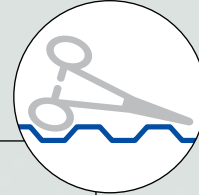

ADDED PROTECTION

Optional basket lid designed for additional protection of set contents.

ERGONOMIC BASKET HANDLING

Large handles designed to improve user control in the Sterile Processing Department (SPD) and during aseptic presentation in the OR.

QUICK SET IDENTIFICATION

Numerous tag options designed to allow for easy set labeling and quick set identification.

BASKET FLEXIBILITY

Smooth and rounded design allows basket to be used with containers or single-use wrap.

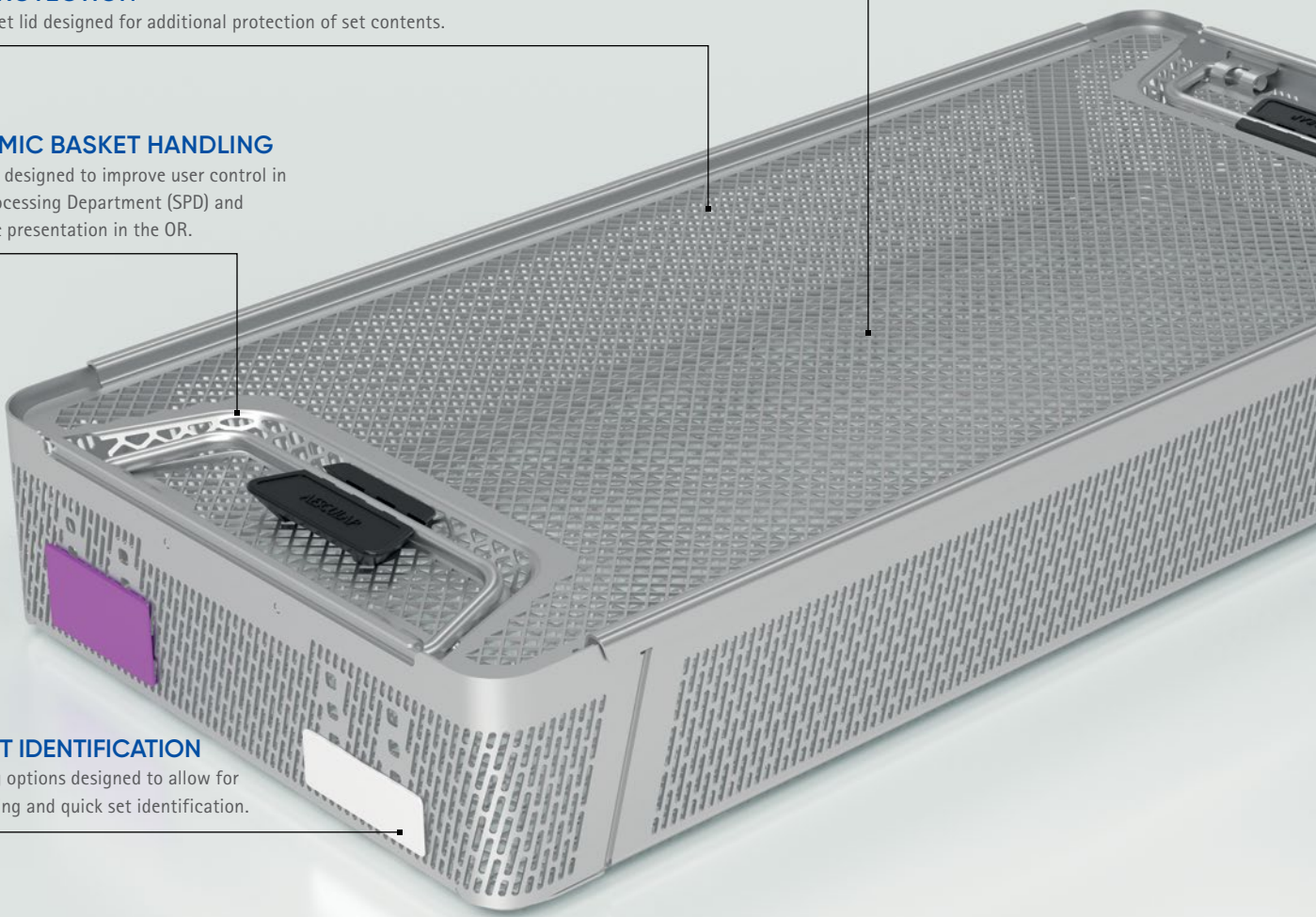



BASKET AND CONTAINER SYNCHRONIZATION

Enables identical tags to be used on the basket and removable container faceplate to streamline the reprocessing cycle and help improve set identification.



SPACE-SAVING BASKET DESIGN

Baskets nest together securely, with or without basket lid, to allow stacking in containers and during storage.

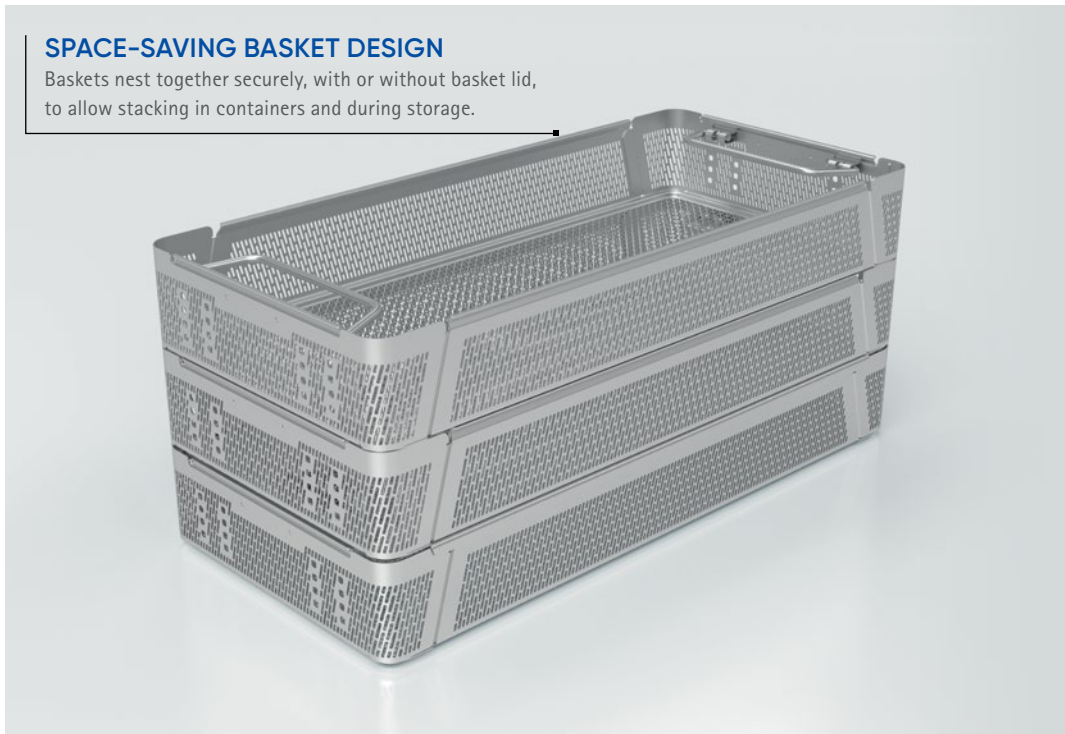

AESCULAP Aicon®

Full-Size Sterile Container System

CONTAINER BOTTOMS

Item no.	Length 23 ⁵ / ₈ in 598 mm	Width 11 ³ / ₄ in 297 mm	Height ¹
JJ110			4 in 100 mm
JJ120			6 in 150 mm
JJ130			8 in 200 mm
JJ140			10 in 250 mm

CONTAINER BOTTOMS WITH ENHANCED DRYING SYSTEM (EDS)



Item no.	Length 23 ⁵ / ₈ in 598 mm	Width 11 ³ / ₄ in 297 mm	Height ¹
JJ111			4 in 100 mm
JJ121			6 in 150 mm
JJ131			8 in 200 mm
JJ141			10 in 250 mm

LIDS FIT ALL FULL-SIZE CONTAINER BOTTOMS

Item no.	Length 23 ⁵ / ₈ in 598 mm	Width 11 ³ / ₄ in 297 mm	Height
JJ410			1 ¹ / ₈ in 28 mm

¹ Height with lid. Inches rounded up to closest 1/8 inch.

AESCULAP Aicon®

Full-Size Sterile Container System Basket Sizes



BASKET COMBINATION OPTIONS

Item no. container bottom	Item no. baskets FULL SIZE
JJ110 JJ111	
JJ120 JJ121	
JJ130 JJ131	
JJ140 JJ141	

Container bottom
 Basket
 Front view

FULL-SIZE BASKET SIZES

Item no.	Length 21¼ in 537 mm Width 10 in 250 mm	Height ¹
JJ161R	1/1 AESCULAP Aicon basket	1½ in 35 mm
JJ162R		2¼ in 55 mm
JJ163R		3¼ in 80 mm
JJ164R		4¼ in 105 mm
JJ167R	1/1 AESCULAP Aicon basket lid	¾ in 18 mm

¹ Inches rounded up to closest 1/8 inch.

AESCULAP Aicon®

Three-Quarter-Size Sterile Container System

CONTAINER BOTTOMS

Item no.	Length 18 ³ / ₈ in 464 mm Width 11 ³ / ₄ in 297 mm	Height ¹
JJ310		4 in 100 mm
JJ320		6 in 150 mm
JJ330		8 in 200 mm
JJ340		10 in 250 mm

CONTAINER BOTTOMS WITH ENHANCED DRYING SYSTEM (EDS)



Item no.	Length 18 ³ / ₈ in 464 mm Width 11 ³ / ₄ in 297 mm	Height ¹
JJ311		4 in 100 mm
JJ321		6 in 150 mm
JJ331		8 in 200 mm
JJ341		10 in 250 mm

LIDS FIT ALL THREE-QUARTER-SIZE CONTAINER BOTTOMS

Item no.	Length 18 ³ / ₈ in 464 mm Width 11 ³ / ₄ in 297 mm	Height
JJ430		1 ¹ / ₈ in 28 mm

¹ Height with lid. Inches rounded up to closest 1/8 inch.

AESCLAP Aicon®

Three-Quarter-Size Sterile Container System Basket Sizes

BASKET COMBINATION OPTIONS



Item no. container bottoms	Item no. baskets THREE-QUARTER SIZE
JJ310 JJ311	
JJ320 JJ321	
JJ330 JJ331	
JJ340 JJ341	

Container bottom
 Basket
 Front view

THREE-QUARTER-SIZE BASKET SIZES

Item no.	Length 15 ⁷ / ₈ in 403 mm Width 10 in 250 mm	Height ¹
JJ361R	3/4 AESCLAP Aicon basket	1 ¹ / ₂ in 35 mm
JJ362R		2 ¹ / ₄ in 55 mm
JJ363R		3 ¹ / ₄ in 80 mm
JJ364R		4 ¹ / ₄ in 105 mm
JJ367R		3/4 AESCLAP Aicon basket lid

¹ Inches rounded up to closest 1/8 inch.

AESCULAP Aicon®

Half-Size Sterile Container System

CONTAINER BOTTOMS

Item no.	Length 11 ⁷ / ₈ in 300 mm Width 11 ³ / ₄ in 297 mm	Height ¹
JJ210		4 in 100 mm
JJ220		6 in 150 mm
JJ230		8 in 200 mm
JJ240		10 in 250 mm

CONTAINER BOTTOMS WITH ENHANCED DRYING SYSTEM (EDS)



Item no.	Length 11 ⁷ / ₈ in 300 mm Width 11 ³ / ₄ in 297 mm	Height ¹
JJ211		4 in 100 mm
JJ221		6 in 150 mm
JJ231		8 in 200 mm
JJ241		10 in 250 mm

LIDS FIT ALL HALF-SIZE CONTAINER BOTTOMS



Item no.	Length 11 ⁷ / ₈ in 300 mm Width 11 ³ / ₄ in 297 mm	Height
JJ420		1 ¹ / ₈ in 28 mm

¹ Height with lid. Inches rounded up to closest 1/8 inch.

AESCULAP Aicon®

Half-Size Sterile Container System Basket Sizes

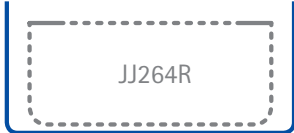
BASKET COMBINATION OPTIONS

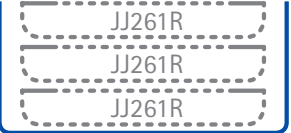
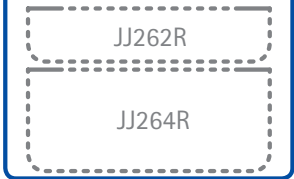
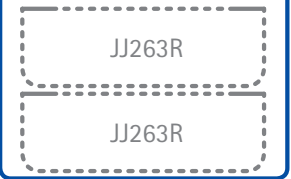
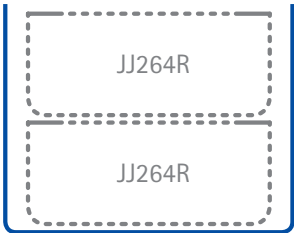
Item no. container bottoms	Item no. baskets HALF SIZE
JJ210 JJ211	
JJ220 JJ221	   
JJ230 JJ231	 
JJ240 JJ241	

Container bottom
 Basket
 Front view

HALF-SIZE BASKET SIZES

Item no.	Length 9½ in 240 mm Width 10 in 250 mm	Height ¹
JJ261R	1/2 AESCULAP Aicon basket	1½ in 35 mm
JJ262R		2¼ in 55 mm
JJ263R		3¼ in 80 mm
JJ264R		4¼ in 105 mm
JJ267R		¾ in 18 mm











¹ Inches rounded up to closest 1/8 inch.

AESCULAP Aicon®

Sterile Container System Identification Faceplates and Tags

Faceplates required if SPD utilizing Identification Cards.

JJ582 Adaptor designed for use with Aesculap Indicator Cards MD346/MD345 located on page 34.

Color	Faceplate		Tag	
	1/pk	10/pk	Large, 1/pk	Small, 1/pk
Red 	JJ500	JJ520	JJ540U	JJ560U
Blue 	JJ501	JJ521	JJ541U	JJ561U
Green 	JJ502	JJ522	JJ542U	JJ562U
Yellow 	JJ503	JJ523	JJ543U	JJ563U
Gray 	JJ504	JJ524	JJ544U	JJ564U
Black 	JJ505	JJ525	-	-
White 	JJ506	JJ526	JJ546U	JJ566U
Orange 	JJ507	JJ527	JJ547U	JJ567U
Violet 	JJ508	JJ528	JJ548U	JJ568U
Brown 	JJ509	JJ529	JJ549U	JJ569U
Size	9 7/8 x 2 3/4 in 248 x 70 mm		2 1/4 x 1 1/4 in 56 x 29 mm	2 1/4 x 3/4 in 56 x 19 mm



Faceplates



Large Tags
2 1/4 x 1 1/4 in
56 x 29 mm



Small Tags
2 1/4 x 3/4 in
56 x 19 mm

Bar Code ID Brackets for Baskets



JJ586U
96 x 34 mm (3 3/4" x 1 1/4")

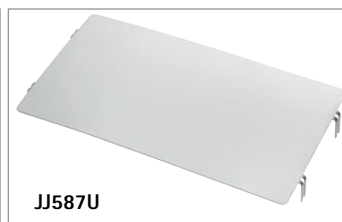

JJ587U
105 x 54 mm (4 1/8" x 2 1/8")



AESCULAP Aicon®

Sterile Container System Processing Supplies and Accessories

SINGLE-USE PAPER FILTER

Item no. 100/pk	Without indicator
JJ612	

RETENTION PLATE

Item no. 1/pk	
JJ600	

COVER FOR PERFORATED AREA

Item no. 1/pk	Item no. 10/pk	
JJ440	JJ441	

Cover designed for transport of used and soiled instruments.

*Refer to AESCULAP Aicon IFU for further information. www.aesculapusaifus.com

RETAINING BRACKET FOR FACEPLATE



Item no. 10/pk	
JJ599	

LABEL ADAPTER FOR FACEPLATE

Item no. 1/pk	3 1/4 x 1 1/2 in 80 x 35 mm
JJ582	

Used in conjunction with Aesculap Indicator Cards MD345/MD346 Pg. 34

CONTAINER LOCK

Item no. 100/pk	Item no. 1000/pk	Blue, without indicator
JJ705	JJ700	
Item no. 100/pk	Item no. 1000/pk	Orange, with steam indicator
JJ725	JJ720	
Item no. 100/pk	Item no. 1000/pk	Yellow, with steam indicator
JJ726	JJ721	

ENHANCED DRYING SYSTEM (EDS) MODULE

Item no. 1/pk	
JJ800	

BIOHAZARD CARD

Item no. 250/box	
US991	

For use with soiled instruments.

*EDS Aicon version not approved for BIO-BIN.

SterilContainer™

System



Validated for
IUSS

Contact your
Sales Representative
for information

BENEFITS

- Extensive range of container sizes and heights designed to meet all your instrument sets requirements
- Lightweight aluminum construction helps you meet AAMI 25lbs weight recommendation
- 90° Stop handle designed to protect staff from finger injuries during handling
- Single motion latch designed to secure containers quickly to help reduce time and hassle in the SPD and OR
- One step retention plate with audible "click" designed to secure filter to simplify operations and help improve processing time
- Able to containerize pre-configured instrument sets including orthopaedic, spine and specialty medical devices
- Solid bottom configured with either Lid Option "VALIDATED for IUSS"

As pictured - Validation with Primeline Pro Lid Reusable Filter for IUSS



SterilContainer™

Full-Size System

Full-Size Containers – Length 23¼ x width 11¼

Perforated Bottoms with Retention Plates



JN440

4 ¼-inch height



JN441

5 ½-inch height



JN442

6-inch height



JN444

8-inch height



JN446

10 ½-inch height

*Basket height includes feet

Solid Bottoms



JK440



JK441



JK442



JK444



JK446

Full-Size Container Lids

Aluminum SterilContainer™ Lid

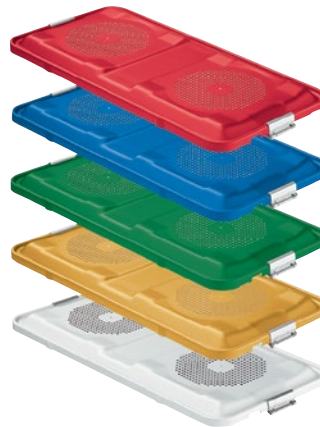

- JK485 Full-size red lid
- JK486 Full-size blue lid
- JK487 Full-size green lid
- JK488 Full-size gold lid
- JK489 Full-size silver lid

Note: Filter requirements when used with aluminum lids:
Perforated full-size container with lids require *four* round filters.
Solid full-size container with lids require *two* round filters.

PrimeLine® Pro Full-Size Container Lids



- JP101 Full-size red lid
- JP102 Full-size blue lid
- JP103 Full-size green lid
- JP104 Full-size gold lid
- JP105 Full-size silver lid

Note: Integrated Reusable PTFE Filter (JP050 included with Lid Purchase) designed for 2200 sterilization cycles.

*All dimensions shown here are outside dimensions with the lid.

SterilContainer™

Full-Size System Basket Sizes and Accessories

Full-Size Stainless Steel Basket Standard Perforation



Length x Width x Height (in.)
Outside dimensions

JF221R	21¼ x 10 x 1½*
JF222R	21¼ x 10 x 2¼*
JF522R	21¼ x 10 x 2¼**
JF223R	21¼ x 10 x 3*
JF224R	21¼ x 10 x 4½*

*Basket height includes feet
**Telescoping with 2¾" handle

Basket Cover for Perforated Baskets



Length x Width x Height (in.)
Outside dimensions

JF227R 2½ x 10 1/16 x ¾

Perforated Basket Cover
for JF Baskets

FULL-SIZE BASKET SIZES

Item no.	Length Width	21¼ in 10 in	537 mm 250 mm	Height ¹
JJ161R	1/1 AESCULAP Aicon® basket			1½ in 35 mm
JJ162R				2¼ in 55 mm
JJ163R				3¼ in 80 mm
JJ164R				4¼ in 105 mm
JJ167R	1/1 AESCULAP Aicon basket lid			¾ in 18 mm



Silicone Mesh Mats and Silicone Holding Mats with Perforations

Silicone Mesh Mats

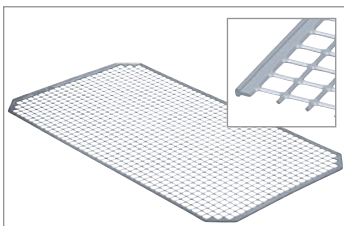

- JF938** - 9½" x 9⅞" Half-size silicone mat
- JF939** - 18⅞" x 9⅞" Din silicone mat
- JF940** - 15⅞" x 9⅞" Three-quarter-size silicone mat
- JF941** - 21⅞" x 9⅞" Full-size silicone mat

Perforated Silicone Holding Mats

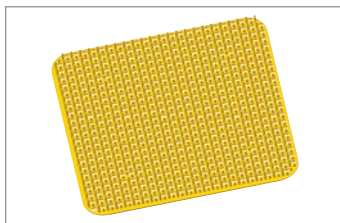
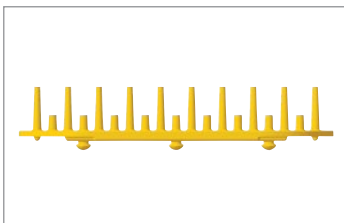

- JF944** - 9¾" x 4" Mini-size silicone mat
- JF945** - 9¾" x 9¼" Half-size silicone mat
- JF947** - 15¼" x 9¼" Three-quarter-size silicone mat
- JF949** - 20¼" x 9¼" Full-size silicone mat

*All dimensions shown here are outside dimensions with the lid.
¹Inches rounded up to closest 1/8 inch. Detailed dimensions on page 14-15.

SterilContainer™

Three-Quarter-Size System

Three-Quarter-Size Containers – Length 18½ x width 11¼

Perforated Bottoms with Retention Plates



JN740

4¼-inch height



JN741

5½-inch height



JN742

6-inch height



JN744

8-inch height

Solid Bottoms



JK740



JK741



JK742



JK744

Three-Quarter-Size Container Lids

Aluminum SterilContainer™ Lid



- JK785 Three-quarter-size red lid
- JK786 Three-quarter-size blue lid
- JK787 Three-quarter-size green lid
- JK788 Three-quarter-size gold lid
- JK789 Three-quarter-size silver lid

Note: Filter requirements when used with aluminum lids:
Perforated three-quarter-size container with lids require *two* round filters.
Solid three-quarter-size container with lids require *one* round filter.

PrimeLine® Pro Three-Quarter-Size Container Lids



- JP111 Three-quarter-size red lid
- JP112 Three-quarter-size blue lid
- JP113 Three-quarter-size green lid
- JP114 Three-quarter-size gold lid
- JP115 Three-quarter-size silver lid



Note: Integrated Reusable PTFE Filter (JP050 included with Lid Purchase) designed for 2200 sterilization cycles.

*All dimensions shown here are outside dimensions with the lid.

SterilContainer™

Three-Quarter System Basket Sizes and Accessories

Three-Quarter-Size Stainless Steel Basket Standard Perforation



Length x Width x Height (in.)
Outside dimensions

JF251R	16 x 10 x 1½*
JF252R	16 x 10 x 2¼*
JF253R	16 x 10 x 3*
JF254R	16 x 10 x 4⅛*

*Basket height includes feet

Perforated Basket

- Fold-in handles
- Plastic feet

Basket Cover for Perforated Baskets



Length x Width x Height (in.)
Outside dimensions

JF257R	16½ x 10⅞ x ¾
---------------	---------------

Perforated Basket Cover for JF Baskets

THREE-QUARTER BASKET SIZES

Item no.	Length Width	15⅞ in 10 in	403 mm 250 mm	Height ¹
JJ361R	3/4 AESCULAP Aicon® basket			1½ in 35 mm
JJ362R				2¼ in 55 mm
JJ363R				3¼ in 80 mm
JJ364R				4¼ in 105 mm
JJ367R	3/4 AESCULAP Aicon basket lid			¾ in 18 mm



Silicone Mesh Mats and Silicone Holding Mats with Perforations

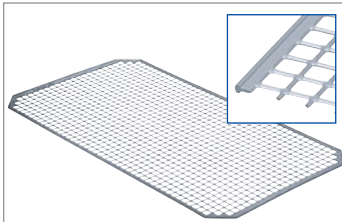

- JF938** - 9½" x 9⅞" Half-size silicone mat
- JF939** - 18⅞" x 9⅞" Din silicone mat
- JF940** - 15⅞" x 9⅞" Three-quarter-size silicone mat
- JF941** - 21⅞" x 9⅞" Full-size silicone mat

Perforated Silicone Holding Mats

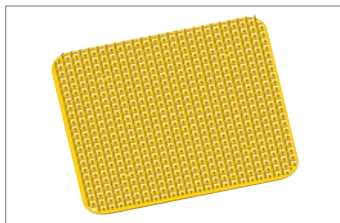
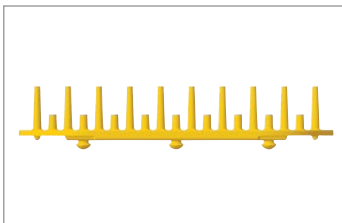

- JF944** - 9¾" x 4" Mini-size silicone mat
- JF945** - 9¾" x 9¼" Half-size silicone mat
- JF947** - 15¼" x 9¼" Three-quarter-size silicone mat
- JF949** - 20¼" x 9¼" Full-size silicone mat

*All dimensions shown here are outside dimensions with the lid.
¹ Inches rounded up to closest 1/8 inch. Detailed dimensions on page 14-15.

SterilContainer™

Half-Size System

Half-Size Containers – Length 11¾ x width 11¼

Perforated Bottoms with Retention Plates



JN340

4¼-inch height



JN341

5½-inch height



JN342

6-inch height



JN344

8-inch height



JN346

10½-inch height

Solid Bottoms



JK340



JK341



JK342



JK344



JK346

Half-Size Container Lids

Aluminum SterilContainer™ 2000 Lid

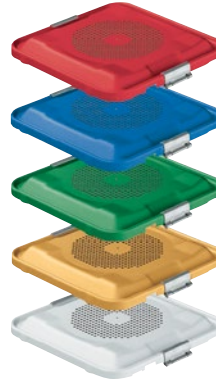

JK385 Half-size red lid

JK386 Half-size blue lid

JK387 Half-size green lid

JK388 Half-size gold lid

JK389 Half-size silver lid

Note: Filter requirements when used with aluminum lids:
Perforated half-size container with lids require *two* round filters.
Solid half-size container with lids require *one* round filter.

PrimeLine® Pro Half-Size Container Lids



JP121 Half-size red lid

JP122 Half-size blue lid

JP123 Half-size green lid

JP124 Half-size gold lid

JP125 Half-size silver lid

Note: Integrated Reusable PTFE Filter (JP050 included with Lid Purchase) designed for 2200 sterilization cycles.

*All dimensions shown here are outside dimensions with the lid.

SterilContainer™

Half-Size System Basket Sizes and Accessories

Half-Size Stainless Steel Basket Standard Perforation

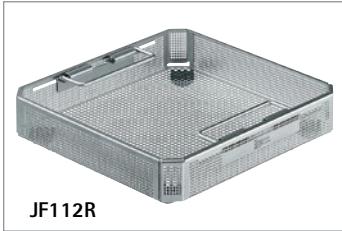

JF112R

Perforated Basket

- Fold-in handles
- Plastic feet

Length x Width x Height (in.)
Outside dimensions

JF111R 10 x 9⁷/₈ x 1¹/₂*

JF112R 10 x 9⁷/₈ x 2¹/₄*

JF113R 10 x 9⁷/₈ x 3*

JF114R 10 x 9⁷/₈ x 4¹/₈*

*Basket height includes feet

Basket Cover for Perforated Baskets



JF117R

Perforated Basket Cover for JF Baskets

Length x Width x Height (in.)
Outside dimensions

JF117R 10¹/₈ x 9³/₄ x ³/₄

HALF-SIZE BASKET SIZES

Item no.	Length Width	9 ¹ / ₂ in 10 in	240 mm 250 mm	Height ¹
JJ261R	1/2 AESCULAP Aicon® basket			1 ¹ / ₂ in 35 mm
JJ262R				2 ¹ / ₄ in 55 mm
JJ263R				3 ¹ / ₄ in 80 mm
JJ264R				4 ¹ / ₄ in 105 mm
JJ267R	1/2 AESCULAP Aicon basket lid			³ / ₄ in 18 mm

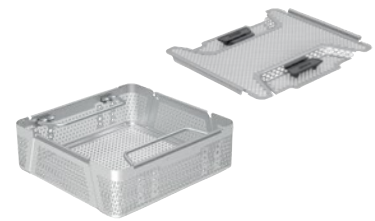

Silicone Mesh Mats and Silicone Holding Mats with Perforations

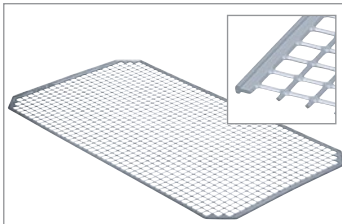

JF938 - 9¹/₂" x 9⁷/₈" Half-size silicone mat

JF939 - 18⁷/₈" x 9⁷/₈" Din silicone mat

JF940 - 15⁷/₈" x 9⁷/₈" Three-quarter-size silicone mat

JF941 - 21¹/₈" x 9⁷/₈" Full-size silicone mat

Perforated Silicone Holding Mats

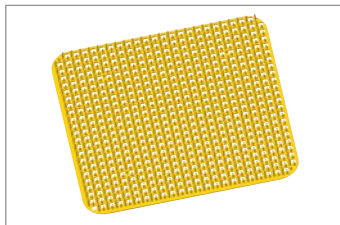
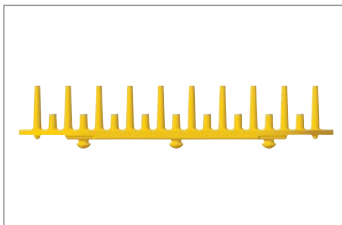

JF944 - 9³/₄" x 4" Mini-size silicone mat

JF945 - 9³/₄" x 9¹/₄" Half-size silicone mat

JF947 - 15¹/₄" x 9¹/₄" Three-quarter-size silicone mat

JF949 - 20¹/₄" x 9¹/₄" Full-size silicone mat

*All dimensions shown here are outside dimensions with the lid.

¹ Inches rounded up to closest 1/8 inch. Detailed dimensions on page 14-15.

SterilContainer™

Extra-Long Mini-Size Container System

Extra-Long Mini-Size Containers – Length 20 x Width 5½

Non-Anodized



JM021
3-inch height

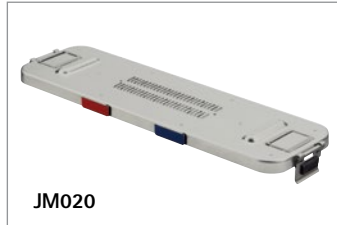

JM020 Lid



MD150 Lid with Handle

Anodized for Steam and EtO



JN021
3-inch height

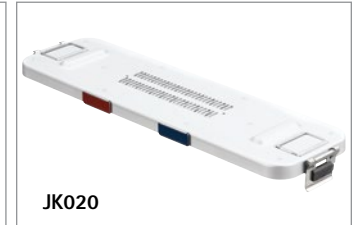

JK020 Lid



MD153 Lid with Handle

Extra-Long Mini-Size Container Baskets



JF435R
Basket Only

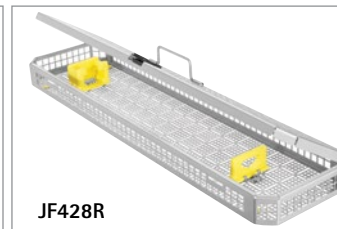

JF428R
Single Scope

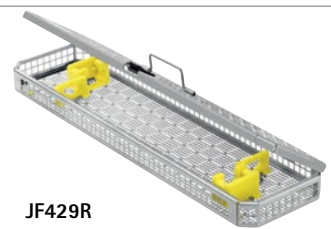

JF429R
Dual Scope

Length x Width x Height (in.)
Outside dimensions

JF435R 20 x 5¼ x 1¾

JF428R 20 x 5¼ x 1¾

JF429R 20 x 5¼ x 1¾

Extra-Long Mini-Size Container Accessories



JG367
Silicone Scope Eyepiece Holder



JG368
Silicone Scope Sleeve Holder



JG369
Support for Angled Optics



JG340
Small Silicone Holder
for 5 mm instruments

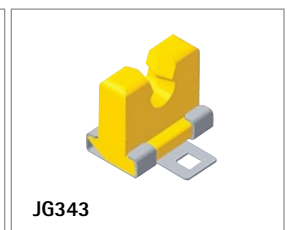

JG343
Small Silicone Holder
for 10 mm instruments

If using JG367/JG368 inserts with Basket Lids
Basket Height MUST be 2"
JG367/JG368: Insert Height 1 1/2"

JG300/JG303R fixation screws sold separately

*All dimensions shown here are outside dimensions with the lid.

SterilContainer™

Extra-Long Container System

Extra-Long Containers – Length 26¼ x Width 11¼

Perforated Bottom



JN445

8-inch height

Solid Bottom



JK443

5½-inch height

Perforated Bottom



JN443

5½-inch height

Lid with Retention Plates



JK490

JK490 – Extra-Long Container Lid

Extra-Long Perforated Basket

Perforated Basket



JF232R

Length x Width x Height (in.)
Outside dimensions

JF232R 26 x 10 x 2¼*

JF532R 26 x 10 x 2¼ with 2¾" telescoping handle*

JF236R 26 x 10 x 3¾ will not work with PL964R rack*

*Basket height includes feet

Extra-Long Container Accessories

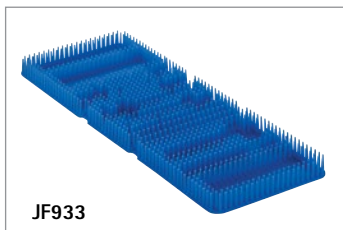

JF933

Extra-Long Silicone Mat

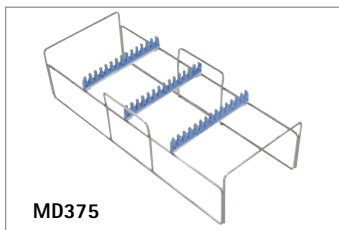

MD375

Endorack – Extra Long,
Holds 14 Instruments.
Fits in JN445 8" Container

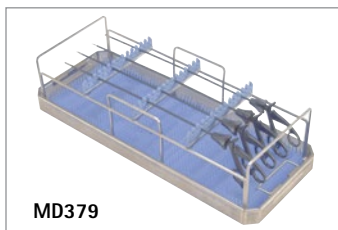

MD379

Endorack – Extra Long Kit
Includes MD375 Rack, JF933 Mat,
JF232R Basket

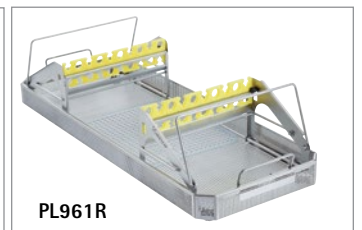

PL961R

PL961R
Endorack Extra-Long,
perforated basket and
silicone mesh mat, for
instruments with shaft-length up to 42
cm, fits into JN445

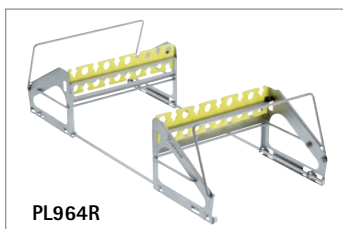

PL964R

PL964R
Endorack Extra-Long, fits into 8" height,
Extra-Long SterilContainer

*All dimensions shown here are outside dimensions with the lid.

SterilContainer™

Quarter-Size System

Quarter-Size Containers – Length 12½ x Width 7½ (Bottom and Lid Sold Separately)

Container System

(Perforated Bottoms Only)

Baskets



JN086

1⅞-inch height



JG381R

Quarter-Size Perforated Basket with Lid and Three Instrument Racks
Length x Width x Height - Outside (in.)
10¾ x 7 x 1⅜



JN088

2½-inch height



JF264R

Quarter-Size Perforated Basket with Lid
Length x Width x Height - Outside (in.)
10¾ x 7 x 1⅝



MD374

Quarter-Size Perforated Basket with Lid and Silicone Cushioning Rack
Length x Width x Height - Outside (in.)
10¾ x 7 x 1⅝



JG384R

Quarter-Size Perforated Basket with Lid and Three Instrument Racks
One JG381R and one JG384R can fit into JN089
Length x Width x Height - Outside (in.)
10¾ x 7 x 1⅝



JN089

3⅝-inch height

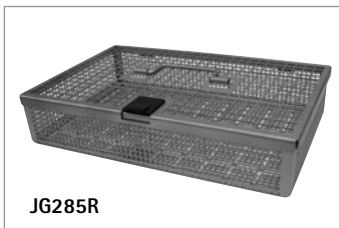

JG285R

Quarter-Size Perforated Basket with Lid
One can fit into JN089
Length x Width x Height - Outside (in.)
10¾ x 6¾ x 2⅜



JN090

5⅞-inch height



JF282R

Quarter-Size Tray
fits into container JN090
Length x Width x Height - Outside (in.)
10⅝ x 6¾ x 3⅝



JF289R

Cover for JF282R

Quarter-Size Lid for tray JF282R
Length x Width x Height - Outside (in.)
10¾ x 7 x ⅝

*All dimensions shown here are outside dimensions with the lid.

Filter Requirements: US999 or JK091 filters.

SterilContainer™

Quarter-Size System Lid Sizes and Accessories

Quarter-Size Aluminum Container Lids



with Handles

Note: MD151 does not include frames for labels.

Bar Code ID Brackets for Baskets

JG616U and JG617U are Bar Code Identification brackets that can be attached to AESCULAP Aicon®, JJ Series, JF Series or perforated baskets to aid in securing bar code labels to the basket. The stainless steel brackets are secured to the baskets by bending the flexible tabs into the perforations.



58 x 23 mm (2¼" x 7/8")



89 x 30 mm (3½" x 1¾")

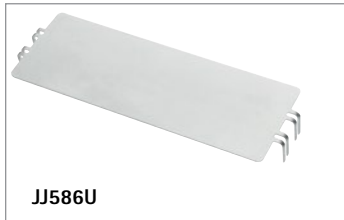

96 x 34 mm (3¾" x 1¼")

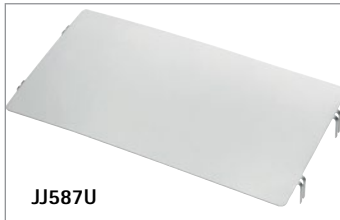

105 x 54 mm (4¼" x 2½")



*All dimensions shown here are outside dimensions with the lid.

SterilContainer™

Mini-Size System

Mini-Size Containers – Length 12¼ x Width 5½

Perforated Bottoms with Retention Plate



JN187

1½-inch height

Solid Bottoms



JK187

1½-inch height

NOTE: *Shallow Mini container does not have an internal basket, however a Mini mat can be used.*



JN188

2⅝-inch height



JK188

2⅝-inch height

Mini-Size Container Lids

Aluminum SterilContainer™ Lid

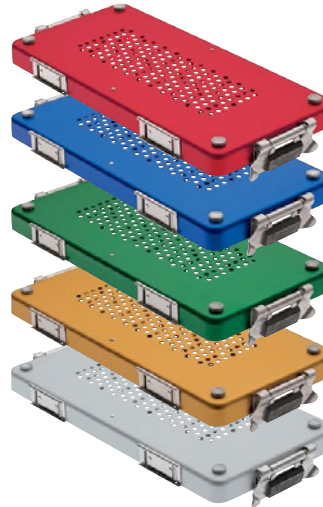

JK170 Mini-size red lid

JK171 Mini-size blue lid

JK172 Mini-size green lid

JK173 Mini-size gold lid

JK174 Mini-size silver lid



MD149 Mini-size silver lid with handles

Mini-Size Container Baskets

Mini Perforated Basket with Lid

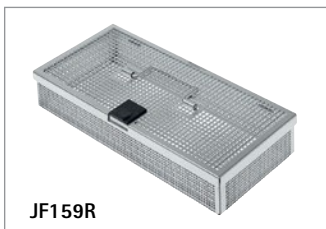

JF159R

Mini-Size Tray for micro instruments fits into an Aesculap Mini container JK188 or JN188.

Length x Width x Height (in.)
Outside dimensions

JF159R 10½ x 5 x 2

Mini Perforated Basket with Lid, Silicone Cushioning Rack and Divider



JG380R

Mini-Size Tray contains three instrument racks fits into JN188 or JK188

Length x Width x Height (in.)
Outside dimensions

JG380R 10¾ x 3¾ x 1⅝

*All dimensions shown here are outside dimensions with the lid.

SterilContainer™

Wide-Body System

Wide-Body Containers – Length 23⁵/₈ x Width 15³/₄

Perforated Bottom with Retention Plates



4³/₄-inch height

Solid Bottoms



7-inch height



Wide-Body Container Lid



JE601

Wide-Body Basket



Wide-Body Baskets

Length x Width x Height (in.)
Outside dimensions

JF833R 21 x 13¹/₄ x 3

*All dimensions shown here are outside dimensions with the lid.

JS Series SterilContainer™ S2

Container System Validated for Steam and Low Temperature

The Aesculap JS Series SterilContainer™ S2 Container System Product family is available for use with Low Temperature (STERRAD®, STERIS® V-PRO® and STERIZONE®), EtO and PreVac Steam sterilization modalities. See Aesculap Instructions for Use (IFU) www.aesculapusaifus.com/.

Full-Size JS Series SterilContainer™ S2 Container System Bottoms – Length 23¼ x Width 11¼



Three-Quarter-Size JS Series SterilContainer™ S2 Container System Bottoms – Length 18½ x Width 11¼



Half-Size JS Series SterilContainer™ S2 Container System Bottoms – Length 11¾ x Width 11¼



JS Series SterilContainer™ S2

Aluminum Lids

Full-Size, Three-Quarter and Half-Size JS Series SterilContainer™ S2 Container System Aluminum Lids

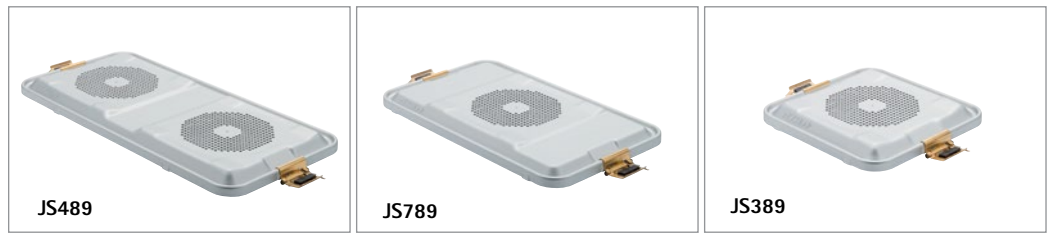

JS489
Full-Size Lid

JS789
Three-Quarter-Size Lid

JS389
Half-Size Lid

SterilContainer™ S Mini-Size Container and Lid – Length 12¼ x Width 5½

Small heat and moisture-sensitive instruments can be secured in the JM188/JM174 Mini-Size container for low temperature sterilization and storage.



JM188
2⅝-inch height

JM174
Handle Option available as Ordering Code MD152

JM174 Lid WITHOUT handles (Shown)
MD152 Mini JM Container lid WITH handles (Picture Not Available)

Mini-Size Container Baskets

Mini Perforated Basket with Lid

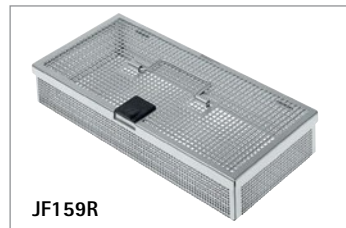

JF159R
Mini-Size Tray for micro instruments fits into an Aesculap Mini container JK188 or JN188.
Length x Width x Height (in.)
Outside dimensions 10½ x 5 x 2

Perforated Silicone Holding Mats

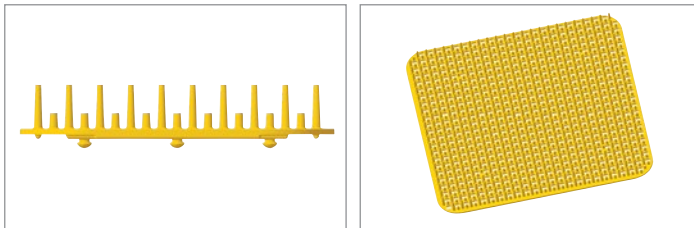

JF944 – 9¾" x 4" Mini-size silicone mat
JF945 – 9¾" x 9¼" Half-size silicone mat
JF947 – 15¼" x 9¼" Three-quarter-size silicone mat
JF949 – 20¼" x 9¼" Full-size silicone mat

SterilContainer™

System Processing Supplies

Tamper Evident Locks





Tamper Evident Locks seal containers for safety and security. Indicator dots change color when exposed to sterilizing conditions. Quantities of 1,000 each.

	Item No.	Color	Description	Qty.	PreVac Steam	PreVac IUSS	Gravity	EtO	Low Temp
	US900	Blue	No Indicator	1,000/pk	X	X	X	X	X
	US905	Green	Change ¹ Yellow to Orange	1,000/pk				X	
	US906	Orange	Change ¹ Blue to Brown	1,000/pk	X	X	X		
	US910	Pink	Change ¹ Magenta to Blue	1,000/pk					X ²
	US399	Yellow	Change ¹ Blue to Brown	1,000/pk		X			

1. After sterilization, the external indicator should change from the original indicator color to the recommended post sterilization indicator color. The recommended post sterilization indicator color may not be evenly shaded but should be shades of the proper processed color to indicate exposure to sterilant.

2. Locks must be stored in a controlled room temperature, away from alkaline chemicals, acids and sources of light.

Indicator Cards

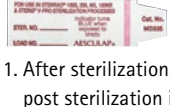
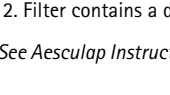
	Item No.	Description	Qty.	PreVac Steam	PreVac IUSS	Gravity	EtO	Low Temp
	MD345	Communication Card No Indicator	250/pk	X	X	X	X	
	MD346	Change ^{1,2} Brown in Steam Change ^{1,2} Orange in EtO	250/pk	X	X	X	X	
	MD399	Change ¹ Brown in Steam	250/pk		X			
	MD876	Change ¹ Brown in Steam for Quarter and Mini Size	250/pk	X		X	X	
	MD334	Change ¹ Blue	250/pk					X
	MD335	Change ¹ Blue for JM188 with JM174	250/pk					X





1. After sterilization, the external indicator should change from the original indicator color to the recommended post sterilization indicator color. The recommended post sterilization indicator color may not be evenly shaded but should be shades of the proper processed color to indicate exposure to sterilant.

2. Filter contains a dual indicator dot, which changes to brown in steam, and to orange in EtO.

SterilContainer™

System Processing Supplies

Filters – Wide, Extra-Long, Full-Size, Three-Quarter and Half-Size Containers

	Item No.	Description	Qty.	PreVac Steam	PreVac IUSS	Gravity	EtO	Low Temp
	US751	Paper Filter with Indicator ¹	1,000/pk	X ¹	X ¹	X ¹	X ¹	
	US994	Paper Filter without Indicator	1,000/pk	X	X	X	X	
	MD344	Polypropylene Filter without Indicator	1,000/pk	X	X		X	X
	JK090	Metal Retention Plate Lid PTFE Reusable Filter	10/pk	X	X			
	JP050	PrimeLine™ PrimeLine Pro PTFE Reusable Filter	1/pk	X	X			

1. Filter contains a dual indicator dot, which changes from blue to brown in steam, and to orange in EtO.

Communication Cards, Biohazard Cards and Indicator Strips



US963 – Communicator Card
For use with US974 Communicator Tag.
Box of 500



US754 – Indicator Strip: (Class 1)
Single-use strip for use in steam and EtO sterilization. Box of 250



MD347 – Process Indicator Card
For use in steam or EtO sterilization. Box of 250 designed for Aesculap Generation 3 Containers, circa 1990's.





US991 – Biohazard Card
For use with soiled instruments.
Box of 250

*EDS Aicon version not approved for BIO-BIN.

SterilContainer™

System Processing Supplies

Quarter-Size, Mini and Extra-Long Mini-Size Containers

	Item No.	Description	Qty.	PreVac Steam	PreVac IUSS	Gravity	EtO	Low Temp
	US999	Paper Filter w/o Indicator	1,000/pk	X	X	X	X	
	MD355	Polypropylene Filter w/o Indicator	1,000/pk	X	X		X	X
	JK091	Metal Retention Plate Lid PTFE Reusable Filter	2/pk	X	X			

Filters – Generation 2 and Prior SterilContainer™ Systems



US992 – Single use
1/4-size
6 1/2" x 9" filter.
Box of 1000

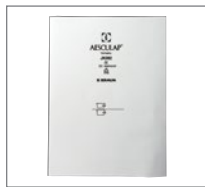

JK092 – Reusable
6 1/2" x 9" filter.
Pack of 2



US756 – Single use
square 9" x 9" filter
with indicator dot.
Box of 1000



US998 – Single use
square 9" x 9" filter.
Box of 1000



JK089 – Reusable
9" x 9" filter.
Pack of 10

SterilContainer™

System Identification Labels and Tags

Identification Labels for Labeling Contents and Delivery Address

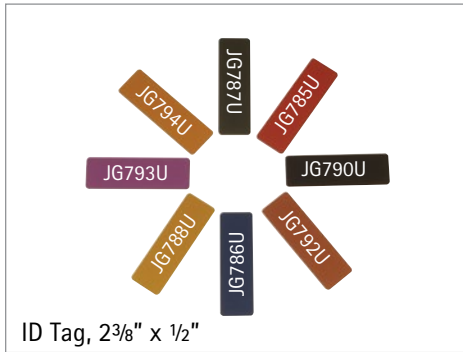

JG785U	Red
JG786U	Blue
JG787U	Green
JG788U	Gold
JG790U	Black
JG792U	Brown
JG793U	Purple
JG794U	Orange



Not recommended for use in vapor hydrogen peroxide sterilization due to color fading.

Identification Labels Specific for Vapor Hydrogen Peroxide Sterilization Cycles

Identification Labels for labeling contents for Vapor Hydrogen Peroxide Sterilization Systems.	US901	Magenta		US901 ID Tag, 2 3/8" x 2/3" (55 mm x 17 mm)
	US917200	Magenta		US917200 Small Snap-on ID Tag, 2 3/8" x 7/8" (60 mm x 30 mm)
	US945200	Magenta		US945200 Large Snap-on ID Tag, 2 3/8" x 1 1/8" (60 mm x 30 mm)

Both the US917200 and US945200 are sold separately, order the MD353 clip if a set with tag and clip is desired

Snap-on Identification Tags for Labeling Contents

Small Tags

US935200	Red
US936200	Blue
US937200	Green
US938200	Gold
US939200	Silver
US940200	Black
US941200	Purple
US942200	Orange
US943200	Bronze

2 3/8" x 1/2" (60 x 15 mm)



Large Tags

US965200	Red
US966200	Blue
US967200	Green
US968200	Gold
US969200	Silver
US970200	Black
US971200	Purple
US972200	Orange
US973200	Bronze

2 3/8" x 1 1/8" (60 x 30 mm)

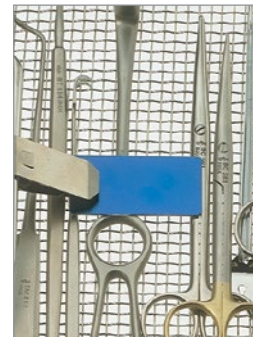

MD353
Stainless Steel
Clip

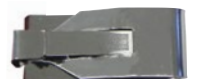

Each Small and Large Tag is sold separately, metal tag clip MD353 also sold separately

Instrument Organization System

Organization and protection of surgical instruments

Aesculap's Instrument Organization System is an advanced system of organizing, storing and protecting your instrument set during transportation and sterilization.

- Instruments organized with the Instrument Organization System are designed to guard against damage from instrument-on-instrument impact during transportation
- Instrument protection can help reduce the cost of repairs and set downtime
- Instrument protection can help increase instrument life and reduces replacement cost

In the O.R., a set organized with Aesculap's Instrument Organization System is designed to help cases flow more efficiently by allowing staff to:

- Quickly identify and select instruments
- Work directly from the organized set
- Replace used instruments into the slots making final instrument count easier

During sterilization, Aesculap's Instrument Organization System is designed for:

- Better sterilant flow between instruments
- Consistent sterilization



Bone tray accessory

Please contact your Aesculap Sales Representative or Customer Resource at (800) 282-9000 for a free consultation in organizing any of your surgical assets in the Aesculap SterilContainer™ System

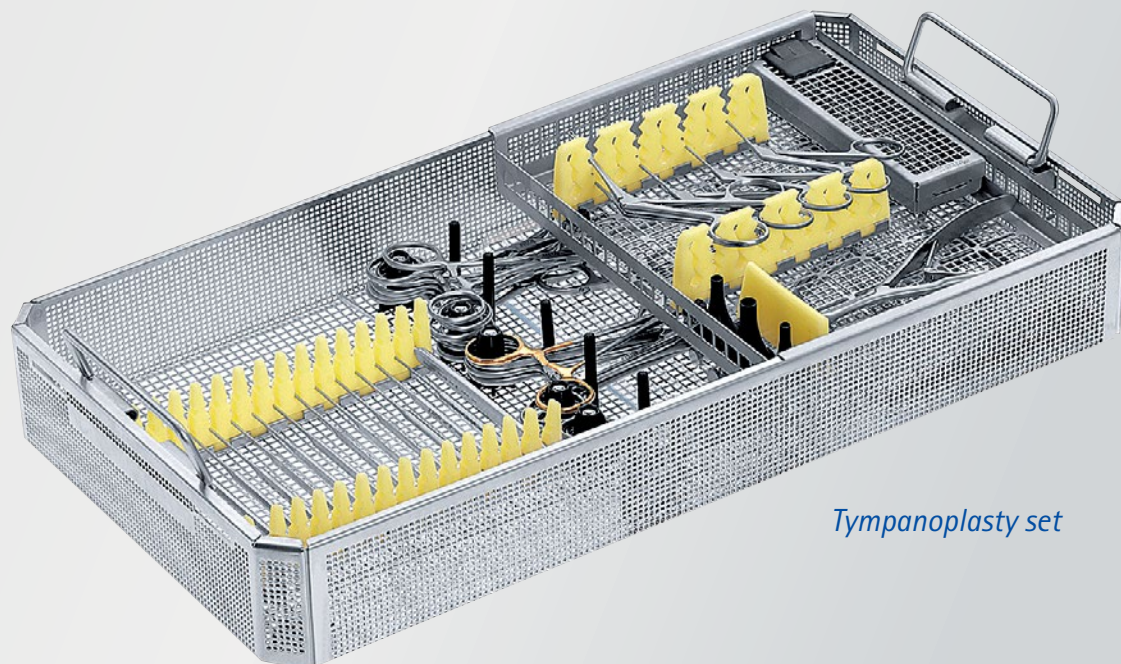

Tympanoplasty set

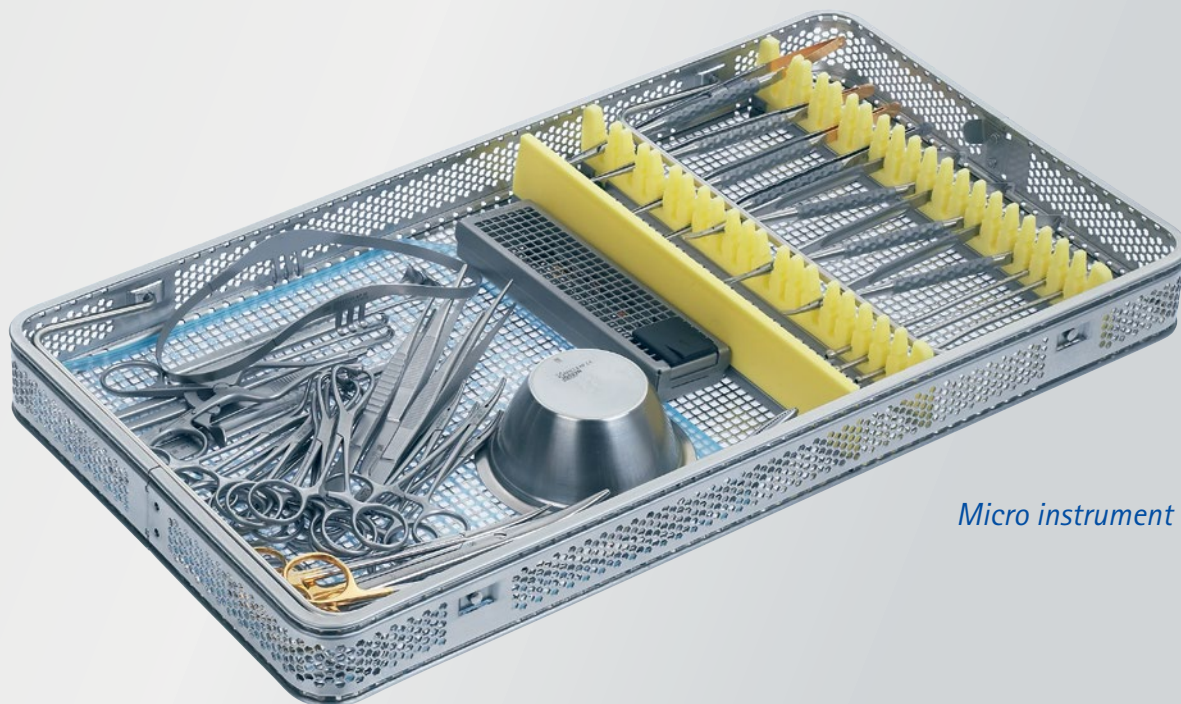

Micro instrument tray

All set examples for illustrative purposes only.

Instrument Organization System

Silicone Instrument Racks (Mounting Type A)*

 <p>JG304 - 4³/₄" x 1¹/₂"</p>	 <p>JG305 - 6¹/₄" x 1¹/₂"</p>	 <p>JG306 - 9¹/₂" x 1¹/₂"</p>	 <p>JG399 - 6" x 1¹/₂"</p>
 <p>JG308 - 4³/₄" x 1¹/₂"</p>	 <p>JG309 - 6¹/₄" x 1¹/₂"</p>	 <p>JG310 - 9¹/₂" x 1¹/₂"</p>	 <p>JG311 - 9¹/₂" x 1¹/₂"</p>
 <p>JG312 - 4³/₄" x 1¹/₂"</p>	 <p>JG313 - 6¹/₄" x 1¹/₂"</p>	 <p>JG314 - 9¹/₂" x 1¹/₂"</p>	
 <p>JG316 - 4³/₄" x 1¹/₂"</p>	 <p>JG317 - 6¹/₄" x 1¹/₂"</p>	 <p>JG318 - 9¹/₂" x 1¹/₂"</p>	
 <p>JG321 - 4⁷/₈" x 3³/₄"</p>	 <p>JG322 - 4⁷/₈" x 3³/₄"</p>	 <p>JG323 - 4⁷/₈" x 3³/₄"</p>	 <p><i>Support for angled instruments</i></p> <p>JG324 - 4⁷/₈" x 1³/₄"</p>
 <p>JG361 - 6⁵/₈" x 2"</p>	 <p>PL962R</p>	<p>PL962R Trocar Storage Set Universal silicone storage racks for trocars</p>	

For basket cover

*For all "Type A" mounting items, see Hardware and Tool Kit options on page 43. JG303R option requires 7 mm Wrench/Socket and T15 sized screwdriver. Hardware for mounting JG303R screws available as GB459R. See page 43.

Please contact your Aesculap Sales Representative or Customer Resource at (800) 282-9000 for a free consultation in organizing any of your surgical assets in the Aesculap SterilContainer™ System

Separating Racks (Mounting Type A)*

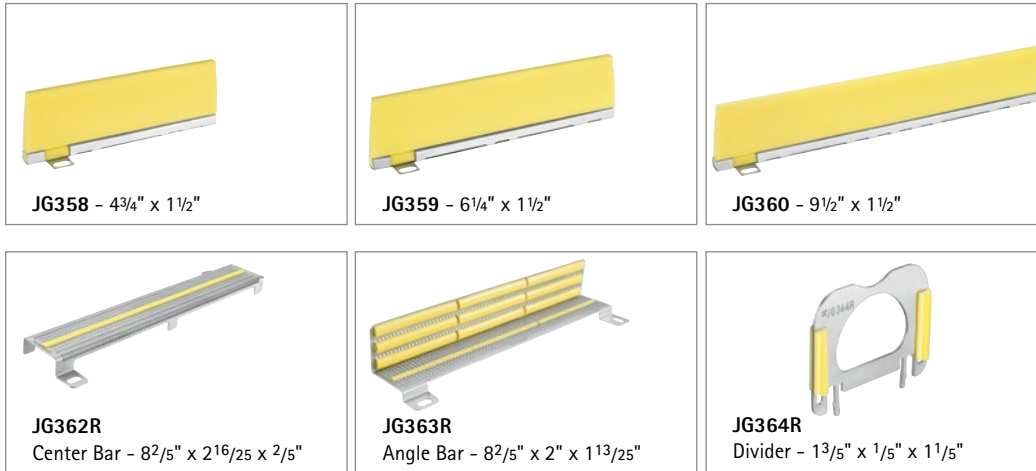

Small Silicone Holders (Mounting Type A)*



Metal Clamp with Silicone Inlay (Mounting Type A)*

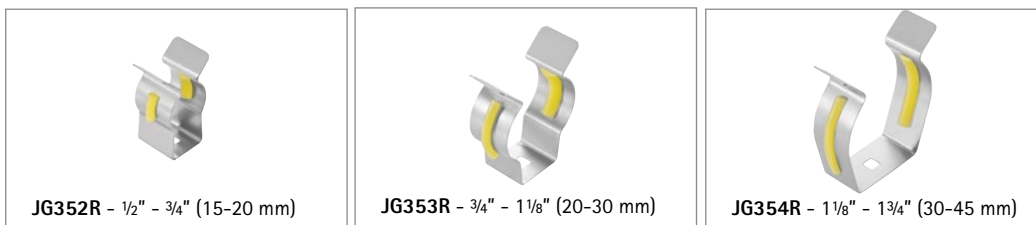

Fixation Pins for Ring Handle Instruments

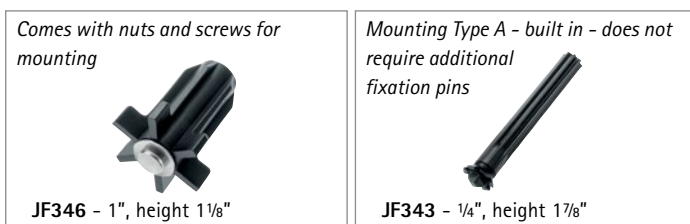

*For all "Type A" mounting items, see Hardware and Tool Kit options on page 43.

Instrument Organization System

Micro Instrument Organization System Instrument Racks

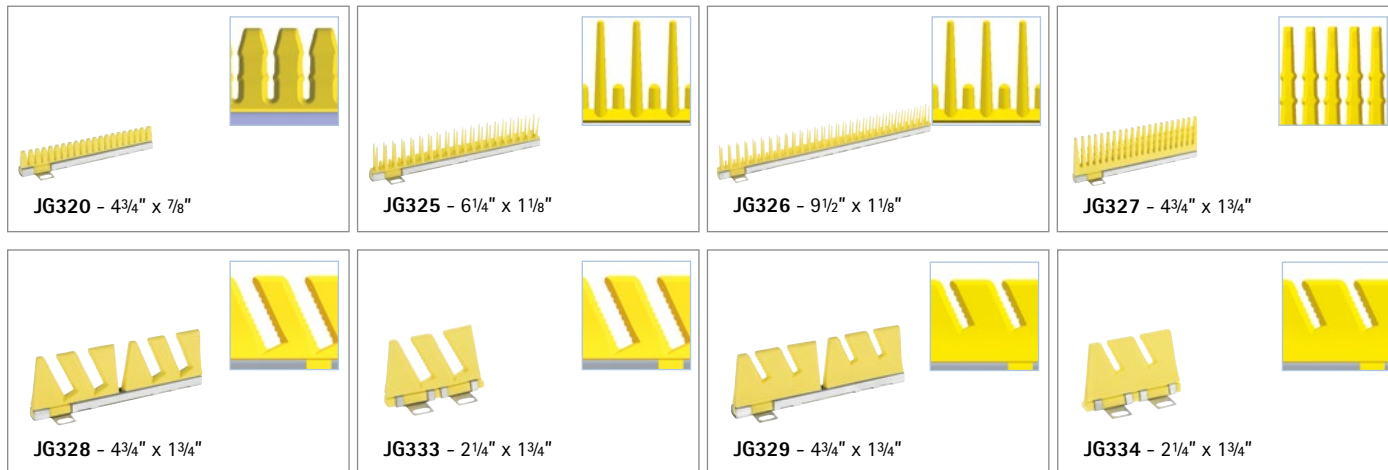

Large Silicone Holders (Mounting Type A)*



Mounting Instructions

Mounting A for instrument racks to be fixed with screws

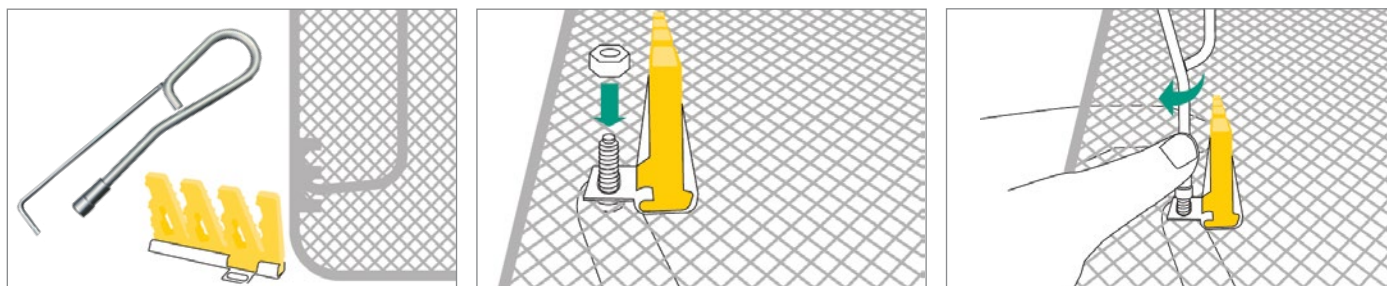

MATERIALS REQUIRED:

- GB459R Toolkit as required
- Instrument holder such as JG341
- AESCULAP baskets (e.g. AESCULAP Aicon® JJ series or JF series)

Place the instrument holder in the required position in the AESCULAP basket, making sure that the holder's fixation lug fits onto the basket's lattice-work correctly. Push the screw through from below and affix it with the nut from above.

Hold the screw with your finger, put on the socket wrench with the other hand and tighten the nut.

*For all "Type A" mounting items, see Hardware and Tool Kit options on page 43.

Please contact your Aesculap Sales Representative or Customer Resource at (800) 282-9000 for a free consultation in organizing any of your surgical assets in the Aesculap SterilContainer™ System

Optics Holders (Mounting Type A)*

Eyepiece holder

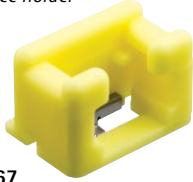

JG367

Sleeve holder

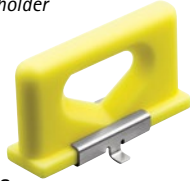

JG368

Support for angled optics



JG369



If using JG367/JG368 inserts with Basket Lids

Basket Height MUST be 2"

JG367/JG368: Insert Height 1 1/2"

Fixation Elements

Fixation pin for Mounting Type A
Can be applied using a flat head
screwdriver



JG300 10 pins/pack

Socket Wrench



JJ589R

10 nuts and 10 bolts/pack



JJ588R

10 nuts and 10 bolts/pack



JG303R

Mounting Hardware Tool Kit
for JG303R



GB459R

Note: Bolt dimension is 7 mm and
Screw is T15

Tray Insert and Silicone Inserts (Mounting Type C)*

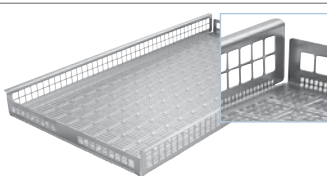

JF210R 17 1/4" x 10"

To be used with tray
inserts JF110F and
JF210F

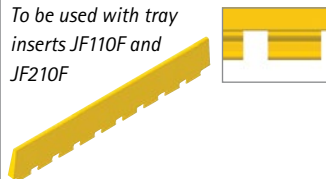

JG370 9 1/2" x 1 1/8"

To be used with tray inserts
JF110F and
JF210F



JG371 9 1/2" x 1 1/8"

To be used with tray inserts
JF110F and
JF210F



JG372 9 1/2" x 1 1/8"

JF110R 10" x 7 3/4" - Designed for Half-Size JF Baskets

JF250R 12" x 10" - Designed for Three-Quarter-Size JF Baskets

JF210R 17 1/4" x 10" - Designed for Full-Size JF Baskets

*For all "Type A" mounting items, see Hardware and Tool Kit options on page 43.

Instrument Organization System

Mounting Type A

For instrument racks with fixation pin:

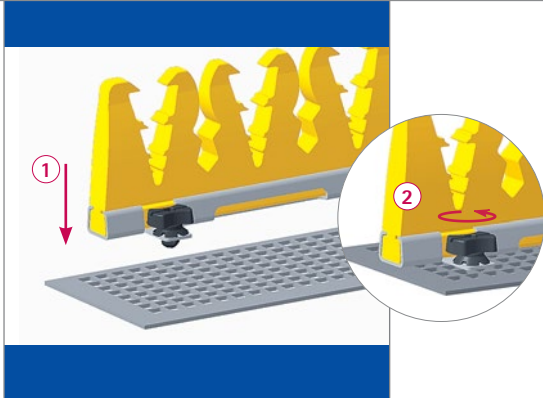

Mounting Type A designed for easy top down assembly of the majority of SterilContainer™ Storage System silicone dividers

- ① Insert fixation pin JG300 in the rack. Install rack with fixation pin in the tray.
- ② Push the fixation pin down, then turn it by 45° using JG302 - Allen screwdriver.

Mounting Type B

For silicone holders with fixation clamps:

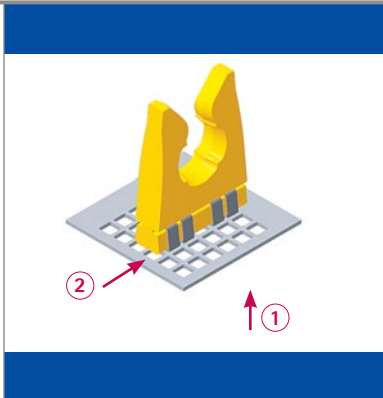

For use with JG330, JG331 and JG332 only

- ① Press fixation clamp JG301R into tray from below.
- ② Slide in silicone holder sideways.

Mounting Type C

For silicone racks in tray inserts:

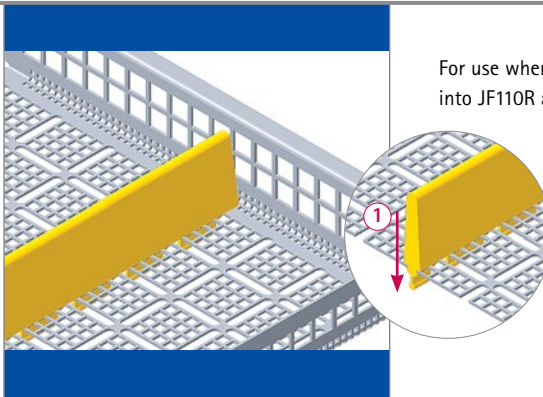

For use when inserting JG310 into JF110R and JF210R

- ① Pull the silicone rack through the longitudinal slots in the tray.

**Mounting Type C can only be used with JF110R and JF210R baskets*

Please contact your Aesculap Sales Representative or Customer Resource at (800) 282-9000 for a free consultation in organizing any of your surgical assets in the Aesculap SterilContainer™ System

Holding Pins



*Holding Clamps and Holding Pins are compatible with both wire mesh perforated baskets.

Item No.	Description	Dimensions	
JF346	Holding Pin for Ring-Handled Instruments	1" dia. x 1 1/8" height	25 mm dia. x 29 mm height
US928	Holding Pin	1 1/4" height	28 mm height
US929	Holding Pin	1 3/4" height	45 mm height
US931	Holding Pin	2 1/4" height	56 mm height
US930	Holding Pin	3 1/2" height	90 mm height

Instrument Organization System

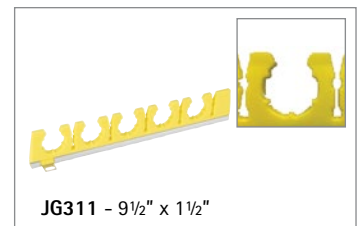
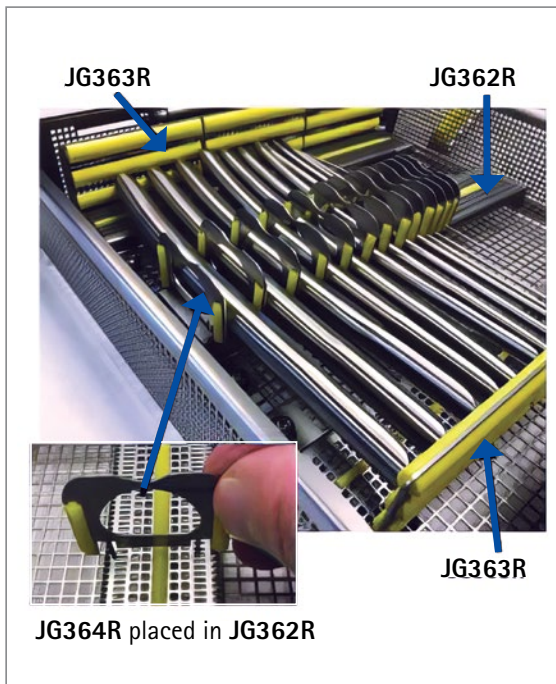
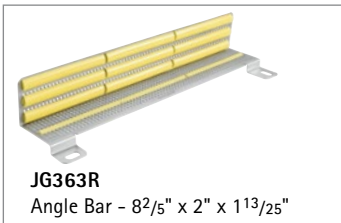

Curette Tray using x2 JG311 IOS

Instrument Organization System

Micro Trays with Lid



JF149R – Mini-Half-Size Basket
 5³/₈" x 4³/₄" x 1⁷/₈"
 135 x 120 x 47 mm
Note: 2 Mini-Half-Size Baskets fit into
 1 Mini-Size SterilContainer™ System



JF150R – Micro Instrument Basket
 with lid
 9¹/₄" x 5³/₈" x 1⁵/₈"
 235 x 137 x 42 mm

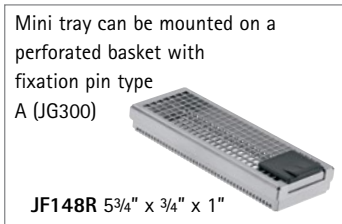

Mini tray can be mounted on a
 perforated basket with
 fixation pin type
 A (JG300)

JF148R 5³/₄" x 3³/₄" x 1"

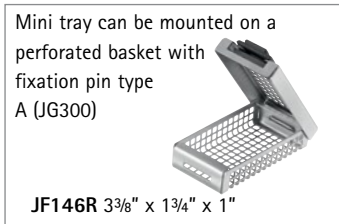

Mini tray can be mounted on a
 perforated basket with
 fixation pin type
 A (JG300)

JF146R 3³/₈" x 1³/₄" x 1"

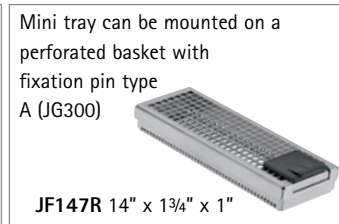

Mini tray can be mounted on a
 perforated basket with
 fixation pin type
 A (JG300)

JF147R 14" x 1³/₄" x 1"

Microinstrument Trays



Components	Container Size		
	Full Size	Three-Quarter Size	Half Size
Bottoms	US437 – 21.25 x 10.00 x 1.50	US436 – 16.00 x 10.00 x 1.50	US435 – 10.00 x 9.88 x 1.50
Lids	US434 – 21.50 x 10.06 x 0.75	US433 – 16.50 x 10.88 x 0.75	US432 – 10.13 x 9.75 x 0.75

*For all "Type A" mounting items, see Hardware and Tool Kit options on page 43.

Please contact your Aesculap Sales Representative or Customer Resource at (800) 282-9000 for a free consultation in organizing any of your surgical assets in the Aesculap SterilContainer™ System

IOS Baskets – Some Assembly Required

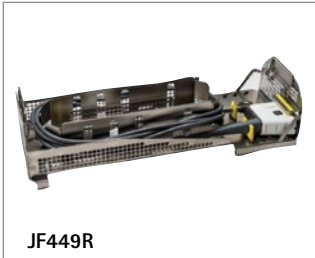

JF449R

JF449R
Da Vinci Single Port (SP) Custom
Camera Container Insert

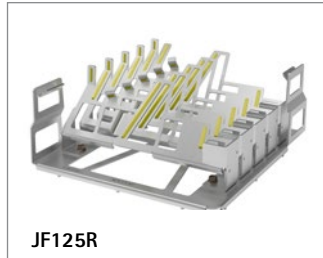

JF125R

JF125R
Rack for five punches
209 mm x 231 mm x 91 mm



JF126R

JF126R
Rack for one punch
192 mm x 68 mm x 83 mm



ME742

ME742
CASPAR Cervical Distractor (CCD)
Basket

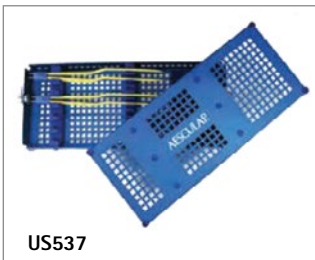

US537

US537 (bottom with lid)
Bipolar Forceps Basket
Holds six forceps up to 11" long
Dimensions with Lid:
12⁹/₁₆" x 5 ³/₈" x 1⁵/₁₆"
Does not fit in MINI or MINI XL



MF320

MF320
Microdissection Instrument Basket
17.25" x 9.98" x 2.81"

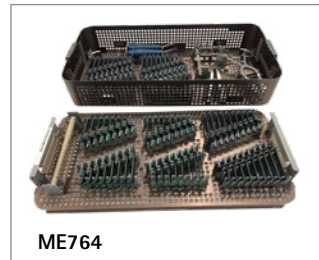

ME764

ME764
CASPAR Cervical Retractor (CCR)
Basket

Instrument Organization System

Set Examples

Transsphenoidal Hypophysectomy Set

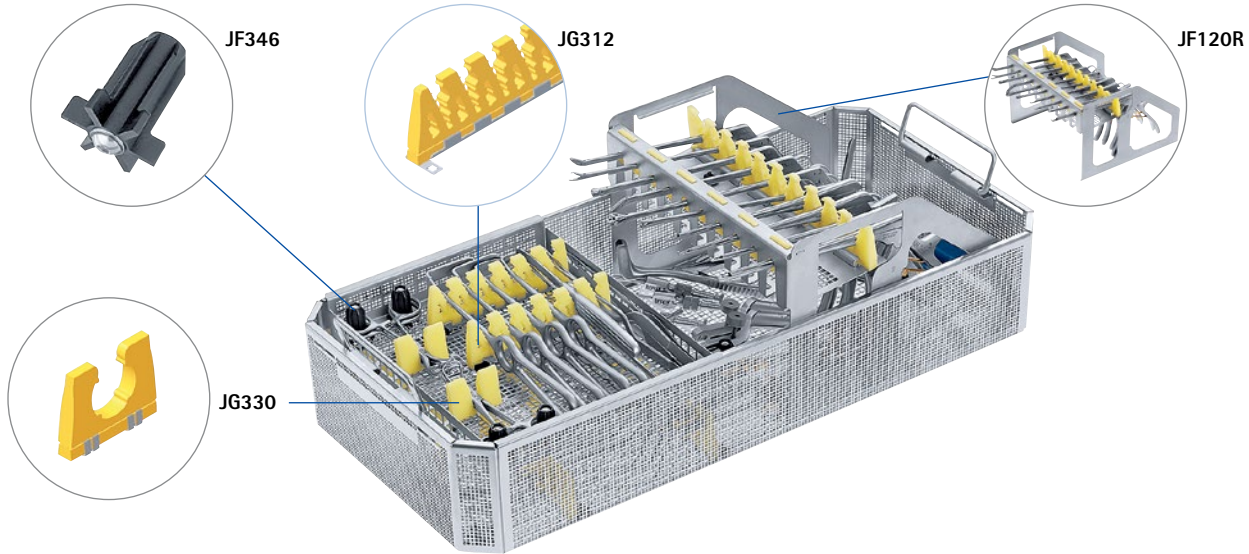

Tympanoplasty Set

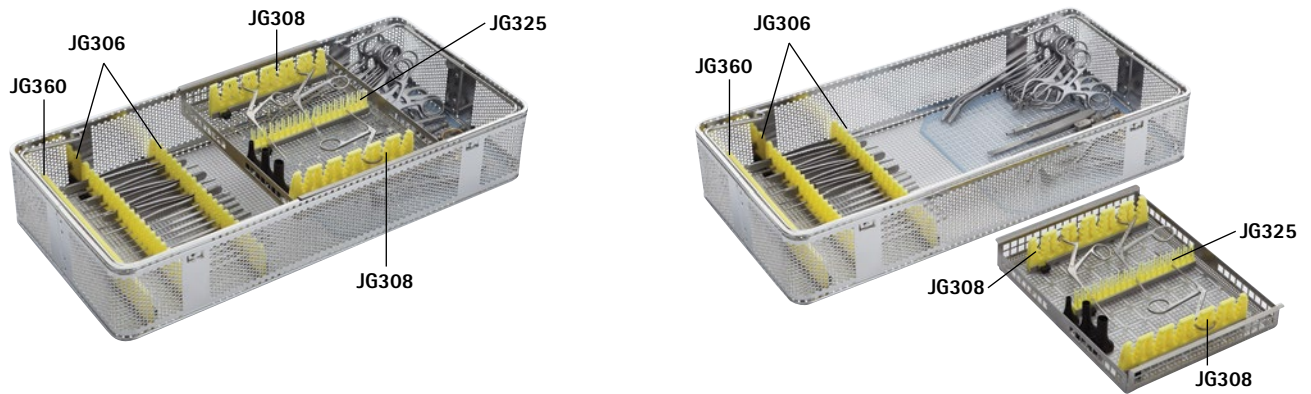

Laparoscopic Vascular Urology Set

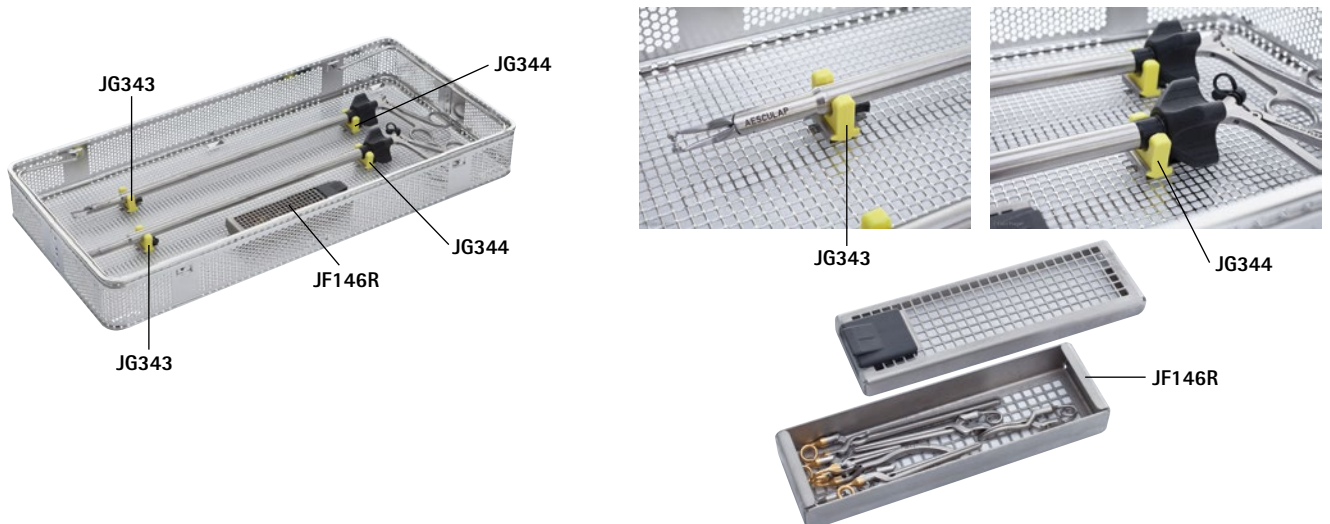

Transnasal Pituitary Set

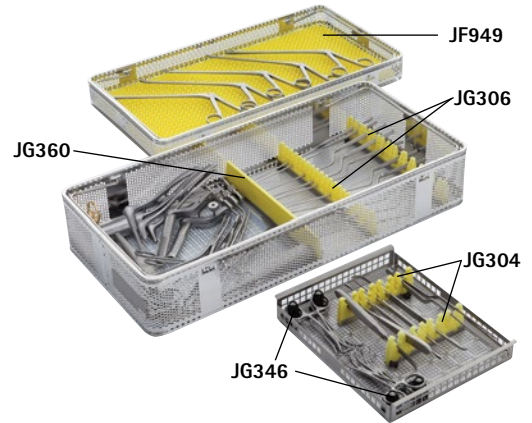
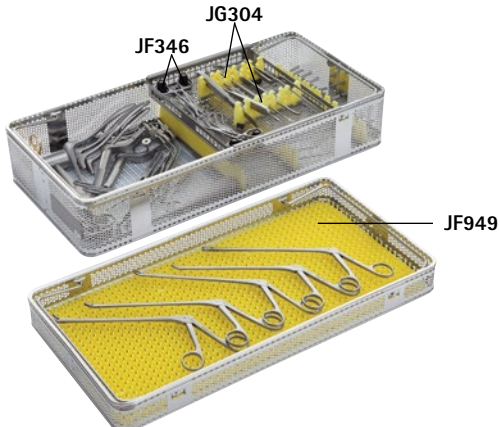

Micro Instrument Skull Base Set

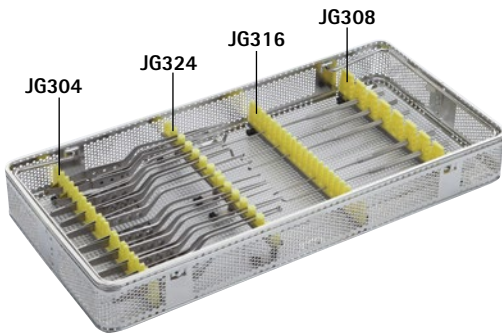

Micro Cardio Vascular Instrument Set

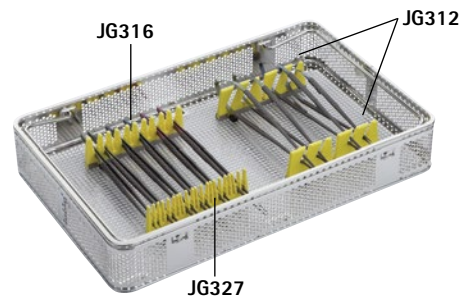

Minimally Invasive Heart Valve Instrument Set



Trocar Set



CABG Micro Instrument Set

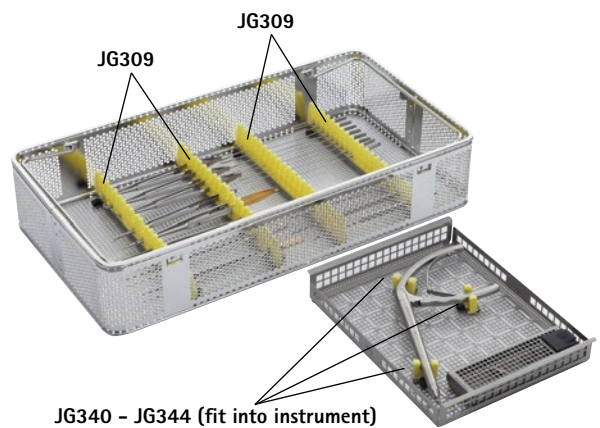
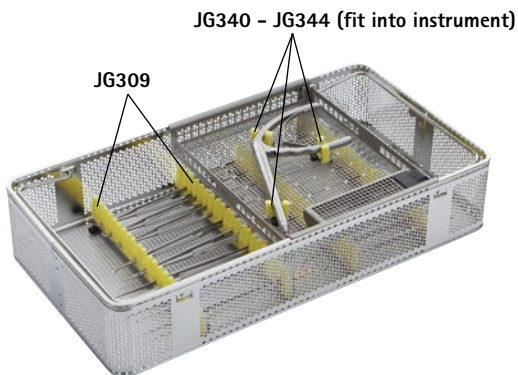

Instrument Organization System

Set Examples

Example Instrument Organization

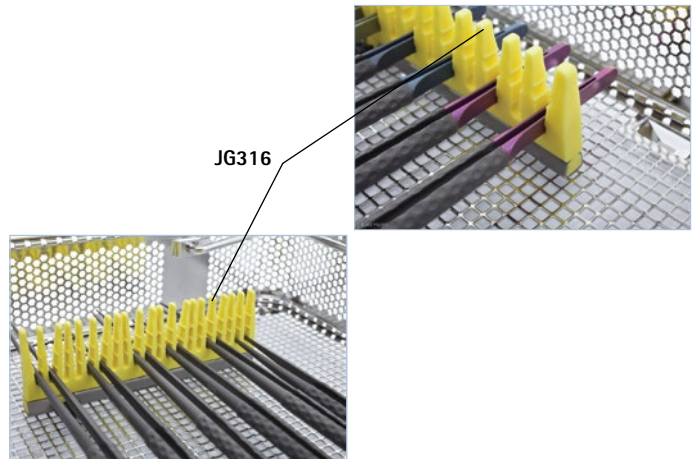
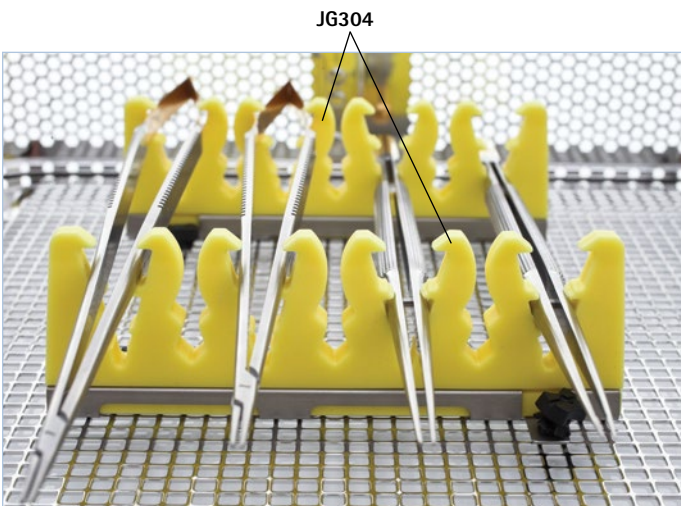
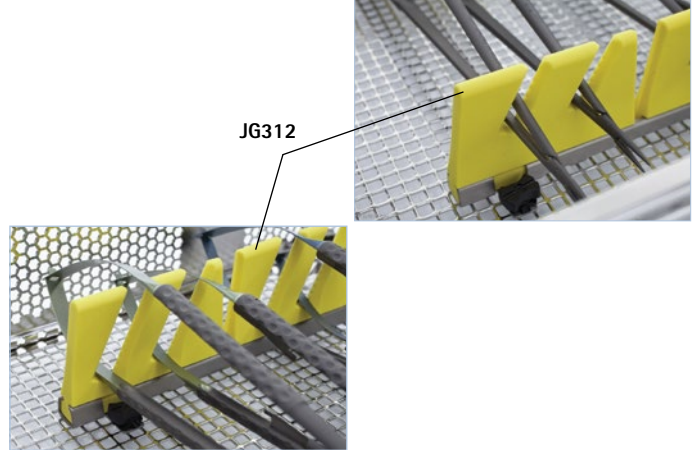
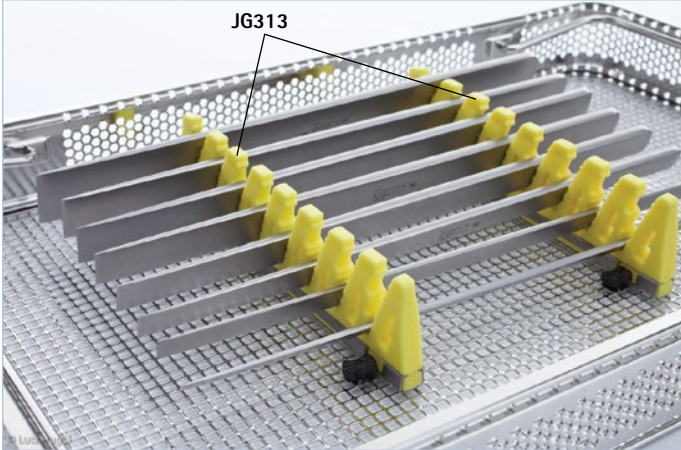

Yellow Mats JF944, JF945, JF947, JF949
(fit into basket)

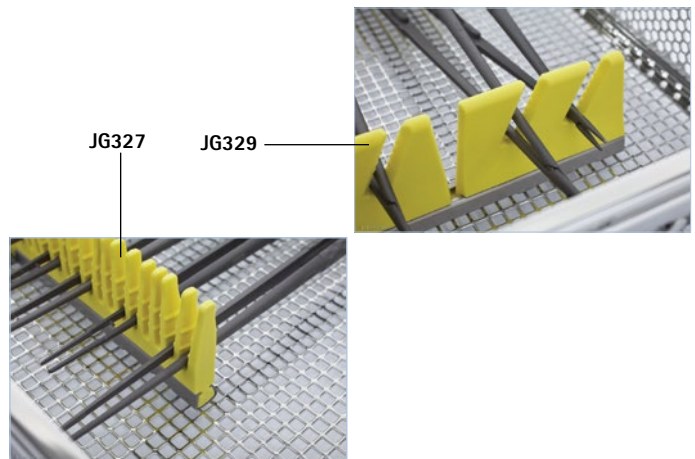
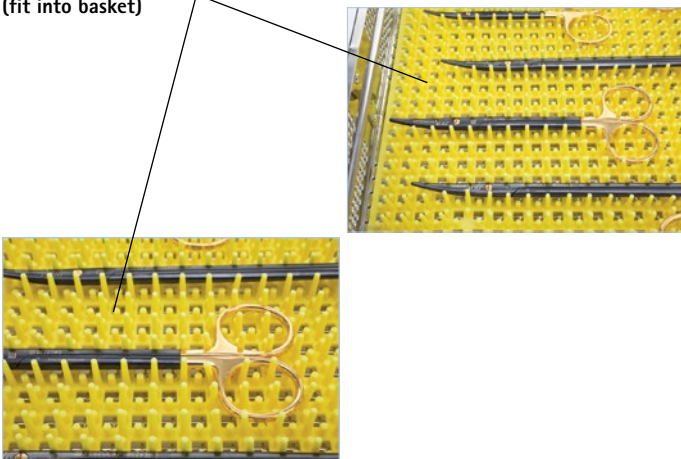

Example Instrument Organization

JG318

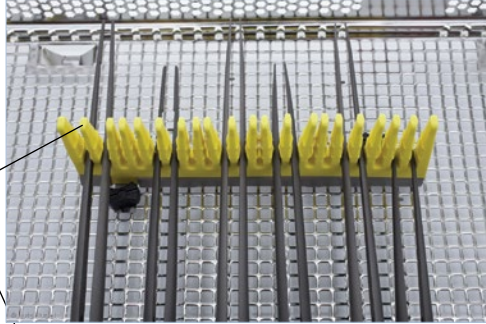

JG304

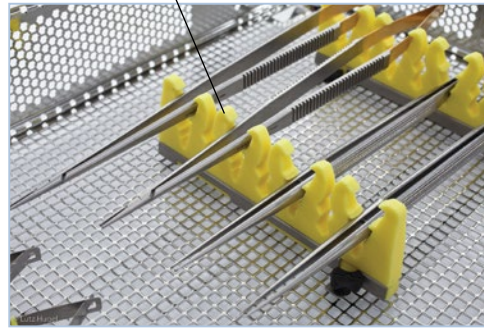
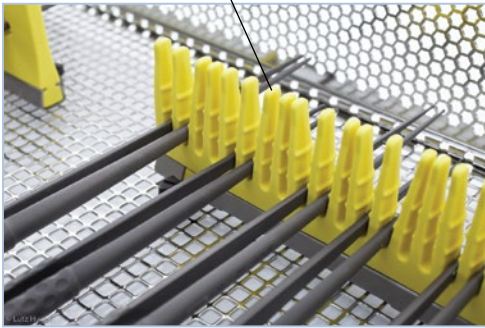
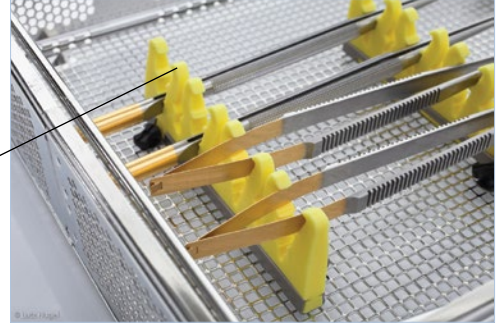

JG304

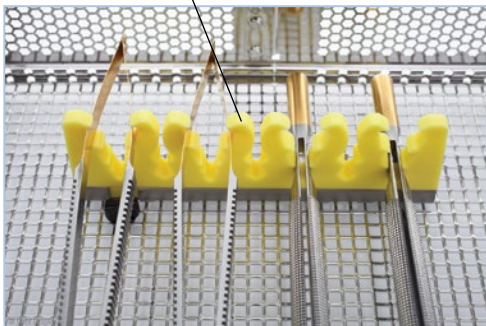
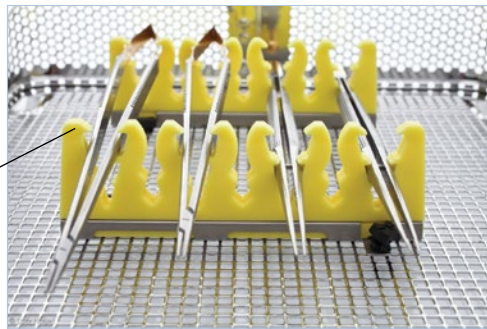

Call your local Aesculap Sales Representative for more set examples and onsite consultation

General Accessories

Endoscopy Storage Accessories

Endoscopy Storage Accessories: Scope Trays and Baskets

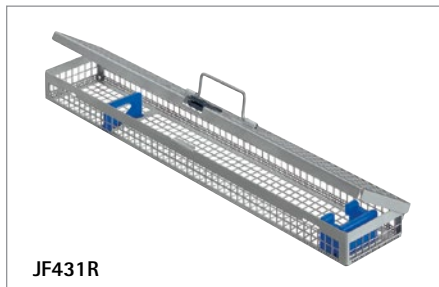

JF431R

JF431R – Single Scope Tray
 17⁷/₈" x 3³/₈" x 1⁵/₈"
 454 x 84 x 41 mm

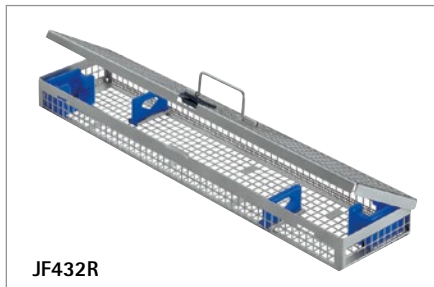

JF432R

JF432R – Double Scope Tray
 17⁷/₈" x 4¹/₁₆" x 1⁵/₈"
 454 x 104 x 41 mm

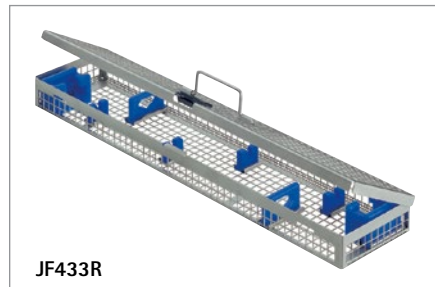

JF433R

JF433R – Double Scope Tray with Silicone Supports
 17⁷/₈" x 4¹/₁₆" x 1⁵/₈"
 454 x 104 x 41 mm

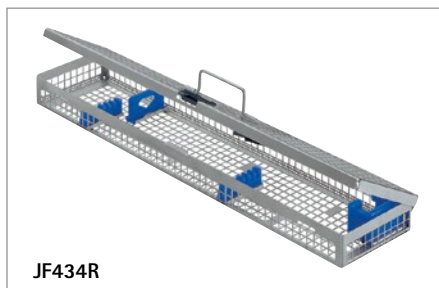

JF434R

JF434R – Single Scope Tray with Silicone Rack
 17⁷/₈" x 4¹/₁₆" x 1⁵/₈"
 454 x 104 x 41 mm



JF436R

JF436R – Single Scope Tray
 (fits inside 1/4 size JN088)
 10³/₄" x 3³/₈" x 1⁵/₈"
 273 x 84 x 41 mm

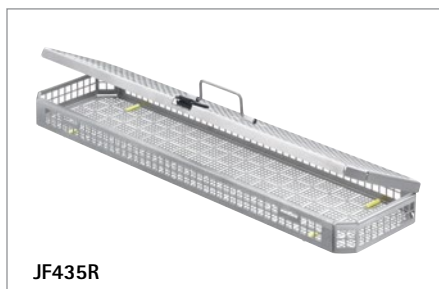

JF435R

JF435R – Scope Basket with Lid
 (fits into Extra-Long Mini Container)
 20" x 5¹/₄" x 1³/₄"
 508 x 133 x 44 mm

All dimensions are length x width x height

Endorack Storage System for MIS Instruments



PL960R

PL960R
Endorack Full-Size,
Perforated basket and
silicone mesh mat, fits into
8" height, Full-Size SterilContainer™



PL961R

PL961R
Endorack Extra-Long,
Perforated basket and silicone mesh
mat, for instruments with shaft-
length up to 42 cm, fits into JN445
and also holds da Vinci SP Robotic
Arms



PL963R

PL963R
Endorack Full-Size,
fits into 8" height, Full-Size
SterilContainer

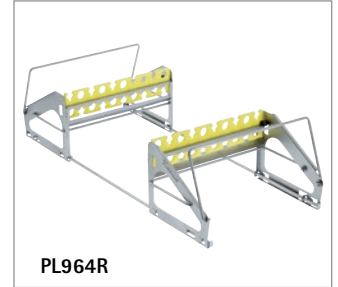

PL964R

PL964R
Endorack Extra-Long, fits into 8"
height, Extra-Long SterilContainer



PL960206

PL960206
Silicone Component
for PL960R, PL961R, PL963R and PL964R

Endoscopy Rack

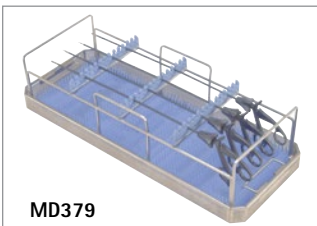

MD379

Holds 14 Instruments

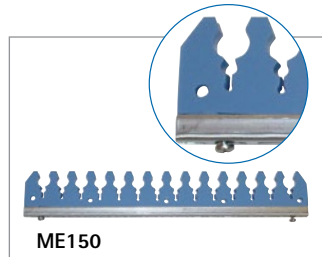

ME150

**ME150 - Full-Size Multi-Keyhole
Bracket**
9¼" x ¾" x 1½"
236 x 9 x 38 mm

	Full-Size	Extra-Long
Rack Only	MD377	MD375
Rack with Basket	MD378 MD377 Rack, PL950215 Mat, JF222R Basket	MD379 MD375 Rack, JF933 Mat, JF232R Basket

General Accessories

Instrument Storage Racks

Racks

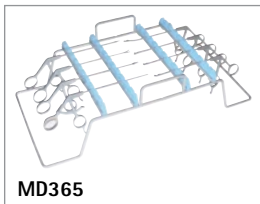

MD365

MD365 – Arthroscopy Rack
Holds 20 arthroscopy punches
Fits into a full-size, 8" deep SterilContainer™
Also will fit with Solid Bottom 6" JK442, with JF222R basket to hold additional instrumentation associated with punches
19³/₈" x 9³/₈" x 4¹/₂"
490 x 238 x 114 mm



MD937

MD937 – Osteotome Rack for Half-Size Container
Holds 12 straight and curved osteotomes (example: MB640 and MB650)
10" x 9⁷/₈" x 2³/₄"
254 x 250 x 70 mm



MD928

MD928 – Cobb Curette Rack
Holds 10 Cobb curettes (example: FK581 - FK599R)
9" x 2¹/₂" x 14"
230 x 65 x 355 mm



MD929

MD929 – Bruns Curette Rack
Holds 10 Bruns curettes (example: MD473 - MD490)
9" x 2¹/₂" x 11¹/₂"
230 x 65 x 295 mm

Storage Frame for Bone Punches

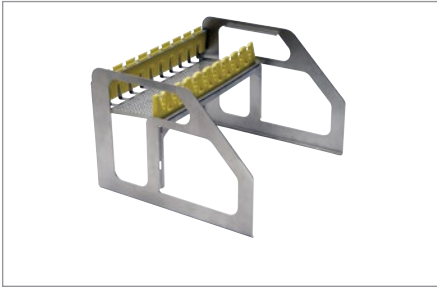

JF120R holds ten instruments.
9½" x 8⅞" x 6⅜"

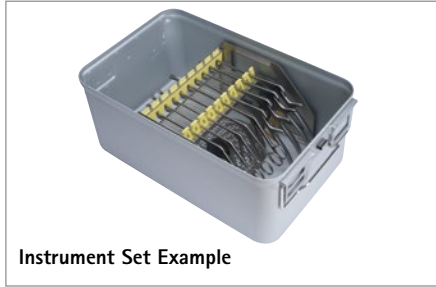

Instrument Set Example

JF120R can be used in the JN744, 8" three-quarter-size container. It is designed to be used in a full-size container for longer instruments.

Lifting Platforms

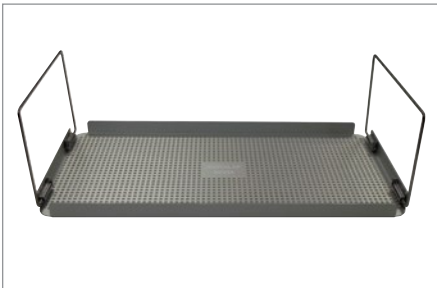

Lifting Platform

Lifting Platform Material Code	Container Height	Handle Height*	Fits Container Codes
US094	4"	2½"	JK/JN 440
US095	5"	3½"	JK/JN 441
US096	6"	4¼"	JK/JN 442
US097	8"	6¼"	JK/JN 444
US098	10"	8½"	JK/JN 446

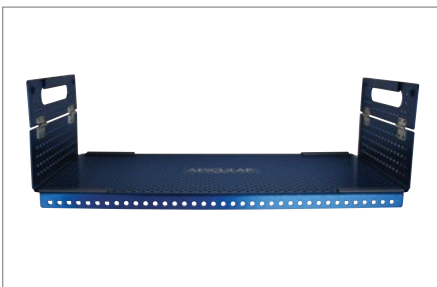

MD301
Fits into full-size 6" container JN/JK442 with handle folded 90°. Fits into full-size 10" container JN/JK446 with handles extended. 6¾" tall with handles extended vertically

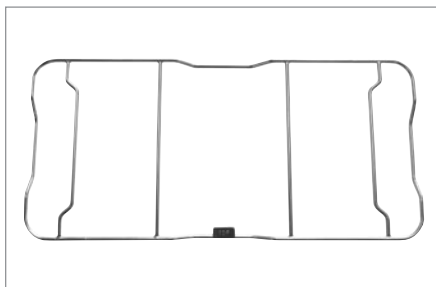

JF101R
For added support for sets in a full-size, solid or perforated bottom container.



All dimensions are length x width x height

General Accessories

Basket Dividers

Basket Dividers



Item No.	Description	Outside Dimensions (length x width x height)	
JF378R	Limiting Bar with Securing Screws	6 1/2" x 1 1/16" x 1/2"	164 x 27 x 12 mm
JF381R	Limiting Bar with Securing Screws	3" x 1 1/16" x 1/2"	76 x 27 x 12 mm
JF921R	Straight divider for baskets	4 3/8" x 5/8" x 1 1/16"	110 x 15 x 28 mm
JF922R	Straight divider for baskets	6 3/8" x 5/8" x 1 1/16"	174 x 15 x 28 mm
JF923R	Straight divider for baskets	9 5/8" x 5/8" x 1 1/16"	244 x 15 x 28 mm
JG378	Basket Lid Instrument Support Holder	4 9/20" x 7/10" x 1 11/50"	113 x 18 x 21 mm
JG379	Basket Lid Instrument Support Holder	4 9/20" x 7/10" x 1 7/20"	113 x 18 x 31 mm

Lid-Mounted IOS Instrument Support Brackets for JG378 and JG379



Holds instrument in place

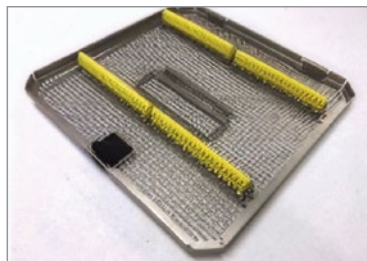

Half-size lid example

Lid Size	Required for Width	Required for Length
Full	2	4
Three-Quarter	2	3
Half	2	2

General Accessories

Micro Instruments Holders and Racks

Micro Instrument Holders and Racks



JF149R – Mini-Half-Size Basket
5 3/8" x 4 3/4" x 1 7/8"
135 x 120 x 47 mm
Note: 2 Mini-Half-Size Baskets fit into
1 Mini-Size SterilContainer™ System



**JF150R – Micro Instrument Basket
with lid**
9 1/4" x 5 3/8" x 1 5/8"
235 x 137 x 42 mm

Repair Tag



US990 – Repair Tag
1000/pack

General Accessories

Mats, Lubricants and Cleaners

Silicone Mesh Mats

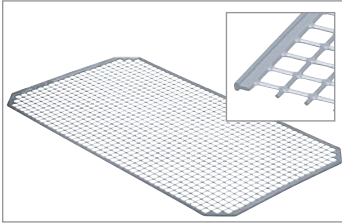

- JF938** – 9½" x 9⅞" (For use with half-size containers)
- JF939** – 18⅞" x 9⅞"
- JF940** – 15⅞" x 9⅞" (For use with three-quarter-size containers)
- JF941** – 21⅞" x 9⅞" (For use with full-size containers)

Silicone Cushioning Pads

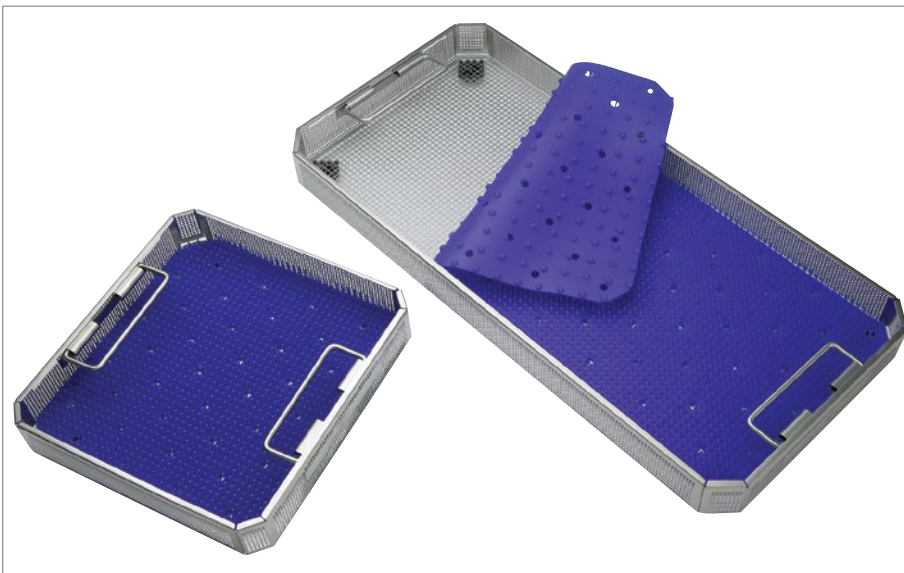

MD894 Mini-size
Silicone Cushioning Pad
4⅜" x 9⅞"
110 x 250 mm

MD895 Quarter-size
Silicone Cushioning Pad
6½" x 10¼"
165 x 260 mm

MD896 Half-size
Silicone Cushioning Pad
9½" x 9⅞"
240 x 250 mm

MD897 Three-quarter-size
Silicone Cushioning Pad
15¾" x 9⅞"
400 x 250 mm

MD898 Full-size
Silicone Cushioning Pad
21¼" x 9⅞"
540 x 250 mm

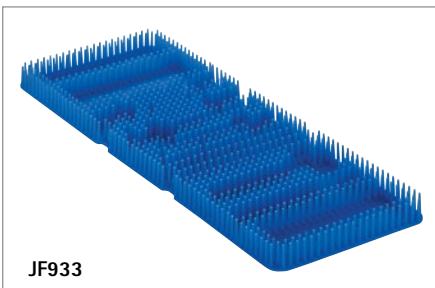

JF933 Extra Long-size Silicone Cushioning Pad
24" x 9" x 1⅞"
610 x 230 x 30 mm

- Designed for safe storage of delicate instruments.
- Pad elevators designed to minimize potential moisture buildup.
- Perforated to help with air and steam circulation.

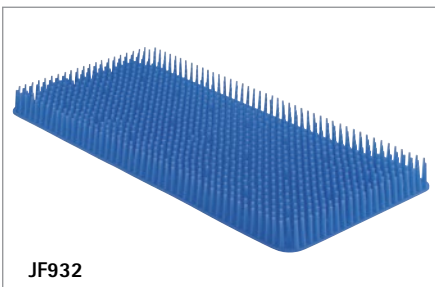

JF932 Silicone Mat, Blue – Full Size
18½" x 9" x 1" in
470 x 230 x 30 mm

All dimensions are length x width x height

Silicone Holding Mats with Perforations

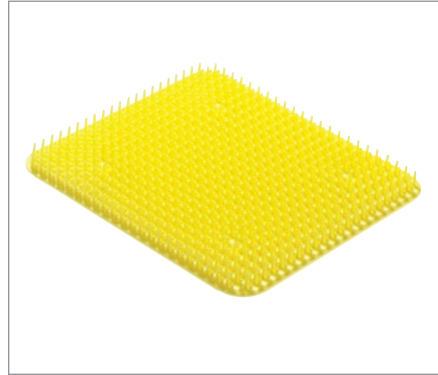
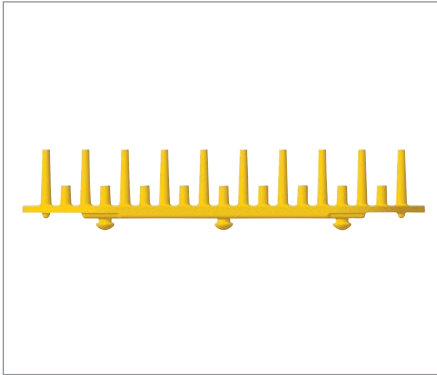

- JF944 - 9¾" x 4" Mini-size silicone mats
- JF945 - 9¾" x 9¼" Half-size silicone mats
- JF947 - 15¼" x 9¼" Three-quarter-size silicone mat
- JF949 - 20¼" x 9¼" Full-size silicone mat

Lubricants and Cleaners



JG598

JG598
Aesculap Instrument Oil for box locks, ratchets, etc.
 Physiologically inert acc. to DAB 7.



JG600

JG600
Aesculap Oil Spray for maintenance of
 instruments prior to sterilization. Physiologically
 inert acc. to DAB 7.
 Minimum order size 6, must be ordered in
 multiples of 6



JG601

JG601
Eloxal Cleaner, 100 ml for cleaning
 container surfaces.

General Accessories

Communicator Tags, Stringers and ID Brackets

Communicator Tag

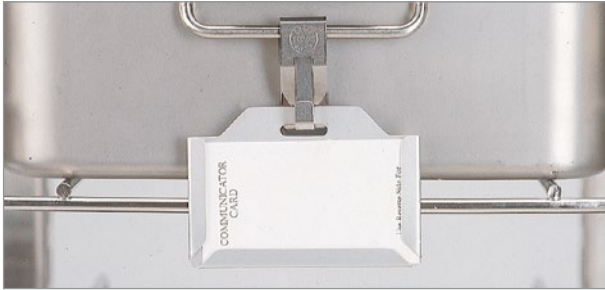

US974200 Communication Card Holder

(MD353 clip sold separately)

(Shown with US963 Communicator Card not included)

Clip only - MD353

US963 Dimensions: 3 1/2" x 2"

Stringers

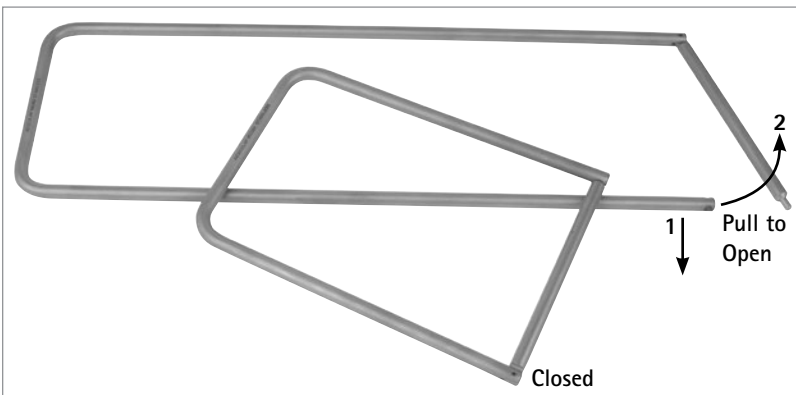

Open Stringers

US897	12" x 2 1/2"
US898	10" x 2 1/2"
US899	8" x 2 1/2"
US811	6" x 2 1/2"

Closed Stringers Push to Open

US890	12" x 2 1/2"
US889	10" x 2 1/2"
US888	8" x 2 1/2"
US926	6" x 2 1/2"
US814	4" x 2 1/2"
US909	12" x 5"
US925	10" x 5"
US904	8" x 5"

All dimensions are from outside edge to outside edge

Notes: Approximately (+/-) 5 Ring Handled Instruments per each (1)" of Stringer length.

Bar Code ID Brackets for Baskets

JG616U and JG617U are Bar Code Identification brackets that can be attached to AESCULAP Aicon®, JJ Series, JF Series or perforated baskets to aid in securing bar code labels to the basket. The stainless steel brackets are secured to the baskets by bending the flexible tabs into the perforations.



JG616U

58 x 23 mm (2 1/4" x 7/8")

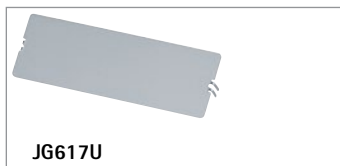

JG617U

89 x 30 mm (3 1/2" x 1 3/16")



JJ586U

96 x 34 mm (3 3/4" x 1 1/4")

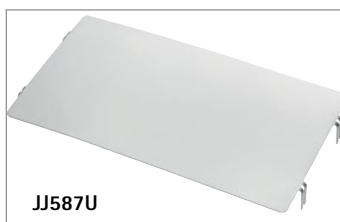

JJ587U

105 x 54 mm (4 1/8" x 2 1/8")



Storage and Transport

Display Boards and Instrument Holders

Instrument Display Board



US872

Instrument Display Board only

34" x 34", Aluminum

864 x 864 mm

Picture shown with US863 Instrument Pegs, US862 Instrument Sleeves, US866 Curette Holder, US865 Slotted Holder and various sized trays.

Each row (total 4) can accommodate (16) US863 Pegs

US867

Dust Cover

Instrument Holders and Board Trays



Item No.	Description
US865	Slotted Holder, 5" (127 mm)
US866	Curette Holder, 5" (127 mm) holds five curettes
US869	Instrument Board Tray, 11" (279 mm)
US870	Instrument Board Tray, 7" (178 mm)

Instrument Peg



US862

Instrument Sleeves

24/Pack

US863

Instrument Peg

6" (152 mm) (Qty = 1)

Miscellaneous

Metal Basins and Bowls

Metal Basins and Bowls

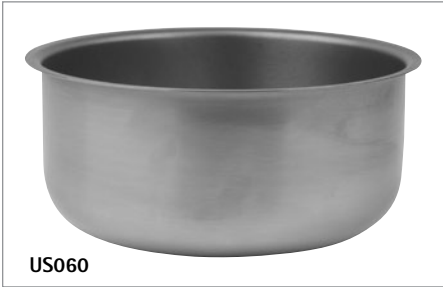

US060

US060 - Metal Sponge Bowl
1½-quart capacity, 7" wide x 3" high



US061

US061 - Metal Sponge Bowl
1-quart capacity, 6" wide x 2½" high



US062

US062 - Metal Sponge Bowl
1⅞-quart capacity, 7½" wide x 3" high



US063

US063 - Metal Iodine Cup
6 oz., 3½" wide x 2" high



US064

US064 - Metal Graduated Measure
32 oz., 4½" wide x 5" high



US065

US065 - Metal Iodine Cup
14 oz., 4½" wide x 2½" high



US066

US066 - Metal Medicine Cup
2 oz., 2" wide x 2" high



US067

US067 - Solution Basin
12 oz., 4½" wide x 2" high



JG504R

JG504R - Kidney Basin
6¾", 250 ml, 1" high x 3½" wide



JG506R

JG506R - Kidney Basin
10", 500 ml, 1" high x 5½" wide



JG508R

JG508R - Kidney Basin
10¾", 750 ml, 1½" high x 6" wide

Miscellaneous

SterilContainer™ Replacement Parts

SterilContainer™ Replacement Parts

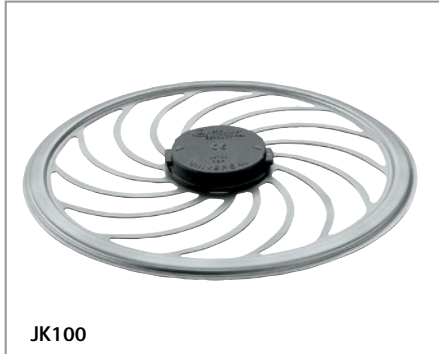

JK100
JK100 – Filter retainer
For use with lids and perforated container bottoms.



JK098
JK098 – Mini filter retainer



JP050
JP050 – Filter for PrimeLine™ lids and PrimeLine Pro



JP055
JP055 – Mounting handle for filter insert, PrimeLine lids



JF112210
JF112210 – Replacement feet for perforated basket



JP001204
JP001204 – Filter cover for PrimeLine and PrimeLine Pro



JP001202
JP001202 – Outside cover for PrimeLine

Miscellaneous

Bio-Bin Containers

Bio-Bin Containers



The stainless steel *BIO-BIN* container is for transportation of soiled instruments and supplies within the hospital, designed to help prevent cross contamination.

Meets OSHA standards.



JK262R
BIO-BIN Full-Size, Stainless Steel Bottom
23" x 11" x 6"
586 x 280 x 150 mm



JK268R
BIO-BIN Full-Size, Stainless Steel Lid
23" x 11" x 11/2"
586 x 280 x 36 mm



JK060R
BIO-BIN Half-Size, Stainless Steel Bottom
11 5/8" x 11" x 4"
295 x 280 x 102 mm



JK062R
BIO-BIN Half-Size, Stainless Steel Bottom
11 5/8" x 11" x 6"
295 x 280 x 150 mm



JK068R
BIO-BIN Half-Size, Stainless Steel Lid
11 5/8" x 11" x 1 1/2"
295 x 280 x 36 mm

All dimensions are length x width x height

AESCULAP Aicon®

Sterile Container System Dimensions

TABLE OF DIMENSIONS FOR STERILE CONTAINERS SIZE FULL-SIZE WITH AND WITHOUT ENHANCED DRYING SYSTEM (EDS)¹

Item no.	Net Weight (lbs)	Lid - outer dimensions (LxWxH)	Sterile container bottom - outer dimensions (LxWxH)	Sterile container bottom - inner dimensions [LxWxH] (loading height)	Sterile container with lid - outer dimensions (LxWxH)
Lid					
JJ410	4.114	23 ⁵ / ₈ x 11 ³ / ₄ x 1 ¹ / ₈ in 598 x 297 x 28 mm			
Sterile container bottom					
JJ110	3.523		23 ⁵ / ₈ x 11 ³ / ₄ x 3 ¹ / ₂ in	21 ⁵ / ₈ x 10 ¹ / ₄ x 2 ⁵ / ₈ in	23 ⁵ / ₈ x 11 ³ / ₄ x 4 in
JJ111	3.536		598 x 297 x 86 mm	548 x 258 x 64 mm	598 x 297 x 100 mm
JJ120	4.495		23 ⁵ / ₈ x 11 ³ / ₄ x 5 ³ / ₈ in	21 ⁵ / ₈ x 10 ¹ / ₄ x 4 ¹ / ₂ in	23 ⁵ / ₈ x 11 ³ / ₄ x 6 in
JJ121	4.508		598 x 297 x 136 mm	548 x 258 x 114 mm	598 x 297 x 150 mm
JJ130	5.467		23 ⁵ / ₈ x 11 ³ / ₄ x 7 ³ / ₈ in	21 ⁵ / ₈ x 10 ¹ / ₄ x 6 ¹ / ₂ in	23 ⁵ / ₈ x 11 ³ / ₄ x 8 in
JJ131	5.481		598 x 297 x 186 mm	548 x 258 x 164 mm	598 x 297 x 200 mm
JJ140	6.442		23 ⁵ / ₈ x 11 ³ / ₄ x 9 ³ / ₈ in	21 ⁵ / ₈ x 10 ¹ / ₄ x 8 ¹ / ₂ in	23 ⁵ / ₈ x 11 ³ / ₄ x 10 in
JJ141	6.455		598 x 297 x 236 mm	548 x 258 x 214 mm	598 x 297 x 250 mm

TABLE OF DIMENSIONS FOR STERILE CONTAINERS SIZE THREE-QUARTER WITH AND WITHOUT ENHANCED DRYING SYSTEM (EDS)¹

Item no.	Net Weight (lbs)	Lid - outer dimensions (LxWxH)	Sterile container bottom - outer dimensions (LxWxH)	Sterile container bottom - inner dimensions [LxWxH] (loading height)	Sterile container with lid - outer dimensions (LxWxH)
Lid					
JJ430	1.626	18 ³ / ₈ x 11 ³ / ₄ x 1 ¹ / ₈ in 464 x 297 x 28 mm			
Sterile container bottom					
JJ310	2.818		18 ³ / ₈ x 11 ³ / ₄ x 3 ¹ / ₂ in	16 ³ / ₈ x 10 ¹ / ₄ x 2 ⁵ / ₈ in	18 ³ / ₈ x 11 ³ / ₄ x 4 in
JJ311	2.818		464 x 297 x 86 mm	414 x 258 x 64 mm	464 x 297 x 100 mm
JJ320	3.631		18 ³ / ₈ x 11 ³ / ₄ x 5 ³ / ₈ in	16 ³ / ₈ x 10 ¹ / ₄ x 4 ¹ / ₂ in	18 ³ / ₈ x 11 ³ / ₄ x 6 in
JJ321	3.631		464 x 297 x 136 mm	414 x 258 x 114 mm	464 x 297 x 150 mm
JJ330	4.445		18 ³ / ₈ x 11 ³ / ₄ x 7 ³ / ₈ in	16 ³ / ₈ x 10 ¹ / ₄ x 6 ¹ / ₂ in	18 ³ / ₈ x 11 ³ / ₄ x 8 in
JJ331	4.458		464 x 297 x 186 mm	414 x 258 x 164 mm	464 x 297 x 200 mm
JJ340	5.258		18 ³ / ₈ x 11 ³ / ₄ x 9 ³ / ₈ in	16 ³ / ₈ x 10 ¹ / ₄ x 8 ¹ / ₂ in	18 ³ / ₈ x 11 ³ / ₄ x 10 in
JJ341	5.271		464 x 297 x 236 mm	414 x 258 x 214 mm	464 x 297 x 250 mm

¹ Inches rounded up to closest 1/8 inch.

TABLE OF DIMENSIONS FOR STERILE CONTAINERS SIZE HALF-SIZE WITH AND WITHOUT ENHANCED DRYING SYSTEM (EDS)¹

Item no.	Net Weight (lbs)	Lid - outer dimensions (LxWxH)	Sterile container bottom - outer dimensions (LxWxH)	Sterile container bottom - inner dimensions [LxWxH] (loading height)	Sterile container with lid - outer dimensions (LxWxH)
Lid					
JJ420	2.937	11 ⁷ / ₈ x 11 ³ / ₄ x 1 ¹ / ₈ in 300 x 297 x 28 mm			
Sterile container bottom					
JJ210	1.940		11 ⁷ / ₈ x 11 ³ / ₄ x 3 ¹ / ₂ in 300 x 297 x 86 mm	10 x 10 ¹ / ₈ x 2 ⁵ / ₈ in 250 x 258 x 64 mm	11 ⁷ / ₈ x 11 ³ / ₄ x 4 in 300 x 297 x 100 mm
JJ211	1.942				
JJ220	2.560		11 ⁷ / ₈ x 11 ³ / ₄ x 5 ³ / ₈ in 300 x 297 x 136 mm	10 x 10 ¹ / ₈ x 4 ¹ / ₂ in 250 x 258 x 114 mm	11 ⁷ / ₈ x 11 ³ / ₄ x 6 in 300 x 297 x 150 mm
JJ221	2.562				
JJ230	3.181		11 ⁷ / ₈ x 11 ³ / ₄ x 7 ³ / ₈ in 300 x 297 x 186 mm	10 x 10 ¹ / ₈ x 6 ¹ / ₂ in 250 x 258 x 164 mm	11 ⁷ / ₈ x 11 ³ / ₄ x 8 in 300 x 297 x 200 mm
JJ231	3.181				
JJ240	3.801		11 ⁷ / ₈ x 11 ³ / ₄ x 9 ³ / ₈ in 300 x 297 x 236 mm	10 x 10 ¹ / ₈ x 8 ¹ / ₂ in 250 x 258 x 214 mm	11 ⁷ / ₈ x 11 ³ / ₄ x 10 in 300 x 297 x 250 mm
JJ241	3.801				

The AESCULAP Aicon® Sterile Container System Instructions for Use are published on <http://www.aesculapusaifus.com/>

NOTES:

¹ Inches rounded up to closest 1/8 inch.

AESCULAP Aicon®

Sterile Container System Dimensions

TABLE OF DIMENSIONS FOR
FULL-SIZE BASKETS¹





Item no.	Basket lid outer dimensions (LxWxH)	Basket outer dimensions (LxWxH)	Basket inner dimensions (LxWxH)
Basket lid			
JJ167R	20 ⁷ / ₈ x 10 x ³ / ₄ in 528 x 253 x 18 mm		
Basket			
JJ161R		21 ¹ / ₄ x 10 x 1 ¹ / ₂ in 537 x 250 x 35 mm	21 ¹ / ₈ x 9 ⁷ / ₈ x 1 ³ / ₈ in 535 x 248 x 32 mm
JJ162R		21 ¹ / ₄ x 10 x 2 ¹ / ₄ in 537 x 250 x 55 mm	21 ¹ / ₈ x 9 ⁷ / ₈ x 2 ¹ / ₈ in 535 x 248 x 52 mm
JJ163R		21 ¹ / ₄ x 10 x 3 ¹ / ₄ in 537 x 250 x 80 mm	21 ¹ / ₈ x 9 ⁷ / ₈ x 3 ¹ / ₈ in 535 x 248 x 77 mm
JJ164R		21 ¹ / ₄ x 10 x 4 ¹ / ₄ in 537 x 250 x 105 mm	21 ¹ / ₈ x 9 ⁷ / ₈ x 4 ¹ / ₈ in 535 x 248 x 102 mm

TABLE OF DIMENSIONS FOR
THREE-QUARTER-SIZE BASKETS¹

Item no.	Basket lid outer dimensions (LxWxH)	Basket outer dimensions (LxWxH)	Basket inner dimensions (LxWxH)
Basket lid			
JJ367R	15 ⁵ / ₈ x 10 x ³ / ₄ in 394 x 253 x 18 mm		
Basket			
JJ361R		15 ⁵ / ₈ x 10 x 1 ¹ / ₂ in 403 x 250 x 35 mm	15 ⁷ / ₈ x 10 x 1 ³ / ₈ in 401 x 248 x 32 mm
JJ362R		15 ⁵ / ₈ x 10 x 2 ¹ / ₄ in 403 x 250 x 55 mm	15 ⁷ / ₈ x 10 x 2 ¹ / ₈ in 401 x 248 x 52 mm
JJ363R		15 ⁵ / ₈ x 10 x 3 ¹ / ₄ in 403 x 250 x 80 mm	15 ⁷ / ₈ x 10 x 3 ¹ / ₈ in 401 x 248 x 77 mm
JJ364R		15 ⁵ / ₈ x 10 x 4 ¹ / ₄ in 403 x 250 x 105 mm	15 ⁷ / ₈ x 10 x 4 ¹ / ₈ in 401 x 248 x 102 mm

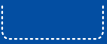
¹ Inches rounded up to closest 1/8 inch.

TABLE OF DIMENSIONS FOR
HALF-SIZE BASKETS¹

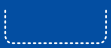
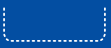
Item no.	Basket lid outer dimensions (LxWxH) 	Basket outer dimensions (LxWxH) 	Basket inner dimensions (LxWxH) 
Basket lid			
JJ267R	9 1/8 x 10 x 3/4 in 231 x 253 x 18 mm		
Basket			
JJ261R		9 1/2 x 10 x 1 1/2 in 240 x 250 x 35 mm	9 3/8 x 9 7/8 x 1 3/8 in 238 x 248 x 32 mm
JJ262R		9 1/2 x 10 x 2 1/4 in 240 x 250 x 55 mm	9 3/8 x 9 7/8 x 2 1/8 in 238 x 248 x 52 mm
JJ263R		9 1/2 x 10 x 3 1/4 in 240 x 250 x 80 mm	9 3/8 x 9 7/8 x 3 1/8 in 238 x 248 x 77 mm
JJ264R		9 1/2 x 10 x 4 1/4 in 240 x 250 x 105 mm	9 3/8 x 9 7/8 x 4 1/8 in 238 x 248 x 102 mm

NOTES:

¹ Inches rounded up to closest 1/8 inch.

SterilContainer™

System Product Dimensions

Full-Size Containers				
<i>Length x Width x Height (Inches and mm)</i>			<i>Length x Width x Height (Inches and mm)</i>	
JN440	Bottom Only	4.7 lbs.	Bottom and Aluminum Lid	
4.7 lbs.	Inches	mm	Inches	mm
<i>Outside Dimension</i>	23 ¹ / ₄ x 10 ³ / ₄ x 3 ¹ / ₂	592 x 274 x 90	23 ¹ / ₄ x 11 ¹ / ₄ x 4 ¹ / ₄	592 x 285 x 108
<i>Inside Dimension</i>			21 ¹ / ₂ x 10 ¹ / ₈ x 2 ¹ / ₂	544 x 258 x 63
JN441	Bottom Only	5.1 lbs.	Bottom and Aluminum Lid	
5.1 lbs.	Inches	mm	Inches	mm
<i>Outside Dimension</i>	23 ¹ / ₄ x 10 ³ / ₄ x 4 ³ / ₄	592 x 274 x 120	23 ¹ / ₄ x 11 ¹ / ₄ x 5 ¹ / ₂	592 x 285 x 138
<i>Inside Dimension</i>			21 ¹ / ₂ x 10 ¹ / ₈ x 3 ⁵ / ₈	544 x 258 x 93
JN442	Bottom Only	5.5 lbs.	Bottom and Aluminum Lid	
5.5 lbs.	Inches	mm	Inches	mm
<i>Outside Dimension</i>	23 ¹ / ₄ x 10 ³ / ₄ x 5 ¹ / ₄	592 x 274 x 135	23 ¹ / ₄ x 11 ¹ / ₄ x 6	592 x 285 x 153
<i>Inside Dimension</i>			21 ¹ / ₂ x 10 ¹ / ₈ x 4 ¹ / ₄	544 x 258 x 108
JN444	Bottom Only	6.4 lbs.	Bottom and Aluminum Lid	
6.4 lbs.	Inches	mm	Inches	mm
<i>Outside Dimension</i>	23 ¹ / ₄ x 10 ³ / ₄ x 7 ³ / ₈	592 x 274 x 187	23 ¹ / ₄ x 11 ¹ / ₄ x 8	592 x 285 x 205
<i>Inside Dimension</i>			21 ¹ / ₂ x 10 ¹ / ₈ x 6 ¹ / ₄	544 x 258 x 160
JN446	Bottom Only	7.4 lbs.	Bottom and Aluminum Lid	
7.4 lbs.	Inches	mm	Inches	mm
<i>Outside Dimension</i>	23 ¹ / ₄ x 10 ³ / ₄ x 9 ³ / ₄	592 x 274 x 247	23 ¹ / ₄ x 11 ¹ / ₄ x 10 ¹ / ₂	592 x 285 x 265
<i>Inside Dimension</i>			21 ¹ / ₂ x 10 ¹ / ₈ x 8 ⁵ / ₈	544 x 258 x 220
JK440	Bottom Only	4.2 lbs.	Bottom and Aluminum Lid	
4.2 lbs.	Inches	mm	Inches	mm
<i>Outside Dimension</i>	23 ¹ / ₄ x 10 ³ / ₄ x 3 ¹ / ₂	592 x 274 x 90	23 ¹ / ₄ x 11 ¹ / ₄ x 4 ¹ / ₄	592 x 285 x 108
<i>Inside Dimension</i>			21 ¹ / ₂ x 10 ¹ / ₈ x 3	544 x 258 x 75
JK441	Bottom Only	4.6 lbs.	Bottom and Aluminum Lid	
4.6 lbs.	Inches	mm	Inches	mm
<i>Outside Dimension</i>	23 ¹ / ₄ x 10 ³ / ₄ x 4 ³ / ₄	592 x 274 x 120	23 ¹ / ₄ x 11 ¹ / ₄ x 5 ¹ / ₂	592 x 285 x 138
<i>Inside Dimension</i>			21 ¹ / ₂ x 10 ¹ / ₈ x 4 ¹ / ₈	544 x 258 x 105
JK442	Bottom Only	5.0 lbs.	Bottom and Aluminum Lid	
5.0 lbs.	Inches	mm	Inches	mm
<i>Outside Dimension</i>	23 ¹ / ₄ x 10 ³ / ₄ x 5 ¹ / ₄	592 x 274 x 135	23 ¹ / ₄ x 11 ¹ / ₄ x 6	592 x 285 x 153
<i>Inside Dimension</i>			21 ¹ / ₂ x 10 ¹ / ₈ x 4 ³ / ₄	544 x 258 x 120
JK444	Bottom Only	6.0 lbs.	Bottom and Aluminum Lid	
6.0 lbs.	Inches	mm	Inches	mm
<i>Outside Dimension</i>	23 ¹ / ₄ x 10 ³ / ₄ x 7 ³ / ₈	592 x 274 x 187	23 ¹ / ₄ x 11 ¹ / ₄ x 8	592 x 285 x 205
<i>Inside Dimension</i>			21 ¹ / ₂ x 10 ¹ / ₈ x 6 ³ / ₄	544 x 258 x 172
JK446	Bottom Only	6.9 lbs.	Bottom and Aluminum Lid	
6.9 lbs.	Inches	mm	Inches	mm
<i>Outside Dimension</i>	23 ¹ / ₄ x 10 ³ / ₄ x 9 ³ / ₄	592 x 274 x 247	23 ¹ / ₄ x 11 ¹ / ₄ x 10 ¹ / ₂	592 x 285 x 265
<i>Inside Dimension</i>			21 ¹ / ₂ x 10 ¹ / ₈ x 9 ¹ / ₈	544 x 258 x 232

*Basket height includes feet

Perforated Baskets

<i>Length x Width x Height (Inches)</i>		<i>Length x Width x Height (mm)</i>		
JF221R	Outside (in.)	Inside (in.)	Outside (mm)	Inside (mm)
1.7 lbs.	21¼ x 10 x 1½*	21⅞ x 9⅞ x ⅞	540 x 253 x 36*	538 x 251 x 22
JF222R	Outside (in.)	Inside (in.)	Outside (mm)	Inside (mm)
2.0 lbs.	21¼ x 10 x 2¼*	21⅞ x 9⅞ x 1⅝	540 x 253 x 56*	538 x 251 x 42
JF223R	Outside (in.)	Inside (in.)	Outside (mm)	Inside (mm)
2.4 lbs.	21¼ x 10 x 3*	21⅞ x 9⅞ x 2½	540 x 253 x 76*	538 x 251 x 62
JF224R	Outside (in.)	Inside (in.)	Outside (mm)	Inside (mm)
2.8 lbs.	21¼ x 10 x 4⅛*	21⅞ x 9⅞ x 3⅝	540 x 253 x 106*	538 x 251 x 92

Basket Cover for Perforated Baskets

<i>Length x Width x Height (Inches and mm)</i>		
JF227R	Outside (in.)	Outside (mm)
1.5 lbs.	21½ x 10⅞ x ¾	544 x 257 x 18

NOTES:

* Inches rounded up to closest 1/8 inch.

SterilContainer™

System Product Dimensions

Three-Quarter-Size Containers				
Length x Width x Height (Inches and mm)			Length x Width x Height (Inches and mm)	
JN740	Bottom Only	3.8 lbs.	Bottom and Aluminum Lid	
3.8 lbs.	Inches	mm	Inches	mm
<i>Outside Dimension</i>	18½ x 10¾ x 3½	470 x 274 x 90	18½ x 11¼ x 4¼	470 x 285 x 108
<i>Inside Dimension</i>			16¼ x 10⅛ x 2½	421 x 258 x 63
JN741	Bottom Only	4.3 lbs.	Bottom and Aluminum Lid	
4.3 lbs.	Inches	mm	Inches	mm
<i>Outside Dimension</i>	18½ x 10¾ x 4¾	470 x 274 x 120	18½ x 11¼ x 5½	470 x 285 x 138
<i>Inside Dimension</i>			16¼ x 10⅛ x 3⅝	421 x 258 x 93
JN742	Bottom Only	4.5 lbs.	Bottom and Aluminum Lid	
4.5 lbs.	Inches	mm	Inches	mm
<i>Outside Dimension</i>	18½ x 10¾ x 5¼	470 x 274 x 135	18½ x 11¼ x 6	470 x 285 x 153
<i>Inside Dimension</i>			16¼ x 10⅛ x 4¼	421 x 258 x 108
JN744	Bottom Only		Bottom and Aluminum Lid	
5.7 lbs.	Inches	mm	Inches	mm
<i>Outside Dimension</i>	18½ x 10¾ x 7⅝	470 x 274 x 187	18½ x 11¼ x 8	470 x 285 x 205
<i>Inside Dimension</i>			16¼ x 10⅛ x 6¼	421 x 258 x 172
JK740	Bottom Only	3.6 lbs.	Bottom and Aluminum Lid	
3.6 lbs.	Inches	mm	Inches	mm
<i>Outside Dimension</i>	18½ x 10¾ x 3½	470 x 274 x 90	18½ x 11¼ x 4¼	470 x 285 x 108
<i>Inside Dimension</i>			16¼ x 10⅛ x 3	421 x 258 x 75
JK741	Bottom Only	4.0 lbs.	Bottom and Aluminum Lid	
4.0 lbs.	Inches	mm	Inches	mm
<i>Outside Dimension</i>	18½ x 10¾ x 4¾	470 x 274 x 120	18½ x 11¼ x 5½	470 x 285 x 138
<i>Inside Dimension</i>			16¼ x 10⅛ x 4⅛	421 x 258 x 105
JK742	Bottom Only	4.2 lbs.	Bottom and Aluminum Lid	
4.2 lbs.	Inches	mm	Inches	mm
<i>Outside Dimension</i>	18½ x 10¾ x 5¼	470 x 274 x 135	18½ x 11¼ x 6	470 x 285 x 153
<i>Inside Dimension</i>			16¼ x 10⅛ x 4¾	421 x 258 x 120
JK744	Bottom Only		Bottom and Aluminum Lid	
5.6 lbs.	Inches	mm	Inches	mm
<i>Outside Dimension</i>	18½ x 10¾ x 7⅝	470 x 274 x 187	18½ x 11¼ x 8	470 x 285 x 205
<i>Inside Dimension</i>			16¼ x 10⅛ x 6¾	421 x 258 x 172

*Basket height includes feet

Perforated Baskets				
Length x Width x Height (Inches)			Length x Width x Height (mm)	
JF251R	Outside (in.)	Inside (in.)	Outside (mm)	Inside (mm)
1.4 lbs.	16 x 10 x 1½*	15 ⁷ / ₈ x 9 ⁷ / ₈ x ⁷ / ₈	406 x 253 x 36*	404 x 251 x 22
JF252R	Outside (in.)	Inside (in.)	Outside (mm)	Inside (mm)
1.6 lbs.	16 x 10 x 2¼*	15 ⁷ / ₈ x 9 ⁷ / ₈ x 1 ⁵ / ₈	406 x 253 x 56*	404 x 251 x 42
JF253R	Outside (in.)	Inside (in.)	Outside (mm)	Inside (mm)
2.0 lbs.	16 x 10 x 3*	15 ⁷ / ₈ x 9 ⁷ / ₈ x 2½	406 x 253 x 76*	404 x 251 x 62
JF254R	Outside (in.)	Inside (in.)	Outside (mm)	Inside (mm)
2.3 lbs.	16 x 10 x 4½*	15 ⁷ / ₈ x 9 ⁷ / ₈ x 3 ⁵ / ₈	406 x 253 x 106*	404 x 251 x 92

Basket Cover for Perforated Baskets		
Length x Width x Height (Inches and mm)		
JF257R	Outside (in.)	Outside (mm)
1.2 lbs.	16½ x 10 ⁷ / ₈ x ¾	419 x 276 x 19

NOTES:

* Inches rounded up to closest 1/8 inch.

SterilContainer™

System Product Dimensions

Half-Size Containers				
<i>Length x Width x Height (Inches and mm)</i>			<i>Length x Width x Height (Inches and mm)</i>	
JN340	Bottom Only	3.0 lbs.	Bottom and Aluminum Lid	
3.0 lbs.	Inches	mm	Inches	mm
<i>Outside Dimension</i>	11 ³ / ₄ x 10 ³ / ₄ x 3 ¹ / ₂	300 x 274 x 90	11 ³ / ₄ x 11 ¹ / ₄ x 4 ¹ / ₄	300 x 285 x 108
<i>Inside Dimension</i>			10 x 10 ¹ / ₈ x 2 ¹ / ₂	254 x 258 x 63
JN341	Bottom Only	3.3 lbs	Bottom and Aluminum Lid	
3.3 lbs.	Inches	mm	Inches	mm
<i>Outside Dimension</i>	11 ³ / ₄ x 10 ³ / ₄ x 4 ³ / ₄	300 x 274 x 120	11 ³ / ₄ x 11 ¹ / ₄ x 5 ¹ / ₂	300 x 285 x 138
<i>Inside Dimension</i>			10 x 10 ¹ / ₈ x 3 ⁵ / ₈	254 x 258 x 93
JN342	Bottom Only	3.5 lbs.	Bottom and Aluminum Lid	
3.5 lbs.	Inches	mm	Inches	mm
<i>Outside Dimension</i>	11 ³ / ₄ x 10 ³ / ₄ x 5 ¹ / ₄	300 x 274 x 135	11 ³ / ₄ x 11 ¹ / ₄ x 6	300 x 285 x 153
<i>Inside Dimension</i>			10 x 10 ¹ / ₈ x 4 ¹ / ₄	254 x 258 x 108
JN344	Bottom Only	4.0 lbs.	Bottom and Aluminum Lid	
4.0 lbs.	Inches	mm	Inches	mm
<i>Outside Dimension</i>	11 ³ / ₄ x 10 ³ / ₄ x 7 ³ / ₈	300 x 274 x 187	11 ³ / ₄ x 11 ¹ / ₄ x 8	300 x 285 x 205
<i>Inside Dimension</i>			10 x 10 ¹ / ₈ x 6 ¹ / ₄	254 x 258 x 160
JN346	Bottom Only	4.7 lbs.	Bottom and Aluminum Lid	
4.7 lbs.	Inches	mm	Inches	mm
<i>Outside Dimension</i>	11 ³ / ₄ x 10 ³ / ₄ x 9 ³ / ₄	300 x 274 x 247	11 ³ / ₄ x 11 ¹ / ₄ x 10 ¹ / ₂	300 x 285 x 265
<i>Inside Dimension</i>			10 x 10 ¹ / ₈ x 8 ⁵ / ₈	254 x 258 x 220
JK340	Bottom Only	2.6 lbs.	Bottom and Aluminum Lid	
2.6 lbs.	Inches	mm	Inches	mm
<i>Outside Dimension</i>	11 ³ / ₄ x 10 ³ / ₄ x 3 ¹ / ₂	300 x 274 x 90	11 ³ / ₄ x 10 ³ / ₄ x 4 ¹ / ₄	300 x 285 x 108
<i>Inside Dimension</i>			10 x 10 ¹ / ₈ x 3	254 x 258 x 75
JK341	Bottom Only	3.1 lbs.	Bottom and Aluminum Lid	
3.1 lbs.	Inches	mm	Inches	mm
<i>Outside Dimension</i>	11 ³ / ₄ x 10 ³ / ₄ x 4 ³ / ₄	300 x 274 x 120	11 ³ / ₄ x 10 ³ / ₄ x 5 ¹ / ₂	300 x 285 x 138
<i>Inside Dimension</i>			10 x 10 ¹ / ₈ x 4 ¹ / ₄	254 x 258 x 108
JK342	Bottom Only	3.2 lbs.	Bottom and Aluminum Lid	
3.2 lbs.	Inches	mm	Inches	mm
<i>Outside Dimension</i>	11 ³ / ₄ x 10 ³ / ₄ x 5 ¹ / ₄	300 x 274 x 135	11 ³ / ₄ x 10 ³ / ₄ x 6	300 x 285 x 153
<i>Inside Dimension</i>			10 x 10 ¹ / ₈ x 4 ³ / ₄	254 x 258 x 120
JK344	Bottom Only	3.9 lbs.	Bottom and Aluminum Lid	
3.9 lbs.	Inches	mm	Inches	mm
<i>Outside Dimension</i>	11 ³ / ₄ x 10 ³ / ₄ x 7 ³ / ₈	300 x 274 x 187	11 ³ / ₄ x 10 ³ / ₄ x 8	300 x 285 x 205
<i>Inside Dimension</i>			10 x 10 ¹ / ₈ x 6 ³ / ₄	254 x 258 x 172
JK346	Bottom Only	4.5 lbs.	Bottom and Aluminum Lid	
4.5 lbs.	Inches	mm	Inches	mm
<i>Outside Dimension</i>	11 ³ / ₄ x 10 ³ / ₄ x 9 ³ / ₄	300 x 274 x 247	11 ³ / ₄ x 10 ³ / ₄ x 10 ¹ / ₂	300 x 285 x 265
<i>Inside Dimension</i>			10 x 10 ¹ / ₈ x 9 ¹ / ₈	254 x 258 x 232

* Basket height includes feet

Perforated Baskets				
Length x Width x Height (Inches)			Length x Width x Height (mm)	
JF111R	Outside (in.)	Inside (in.)	Outside (mm)	Inside (mm)
1.1 lbs.	10 x 9 ⁷ / ₈ x 1 ¹ / ₂ *	9 ¹ / ₂ x 9 ⁵ / ₈ x ⁷ / ₈	253 x 243 x 36*	251 x 241 x 22
JF112R	Outside (in.)	Inside (in.)	Outside (mm)	Inside (mm)
1.3 lbs.	10 x 9 ⁷ / ₈ x 2 ¹ / ₄ *	9 ¹ / ₂ x 9 ⁵ / ₈ x 1 ⁵ / ₈	253 x 243 x 56*	251 x 241 x 42
JF113R	Outside (in.)	Inside (in.)	Outside (mm)	Inside (mm)
1.5 lbs.	10 x 9 ⁷ / ₈ x 3*	9 ¹ / ₂ x 9 ⁵ / ₈ x 2 ¹ / ₂	253 x 243 x 76*	251 x 241 x 62
JF114R	Outside (in.)	Inside (in.)	Outside (mm)	Inside (mm)
1.8 lbs.	10 x 9 ⁷ / ₈ x 4 ¹ / ₈ *	9 ¹ / ₂ x 9 ⁵ / ₈ x 3 ⁵ / ₈	253 x 243 x 106*	251 x 241 x 92

Basket Cover for Perforated Baskets		
Length x Width x Height (Inches and mm)		
JF117R	Outside (in.)	Outside (mm)
.8 lbs.	10 ¹ / ₈ x 9 ³ / ₄ x ³ / ₄	257 x 247 x 18

NOTES:

* Inches rounded up to closest 1/8 inch.

SterilContainer™

System Product Dimensions

Quarter-Size Containers for Dental

Filter Requirements: Perforated Bottoms with lids require two US992 filters. (6.5" x 9")

<i>Length x Width x Height (Inches)</i>		<i>Length x Width x Height (mm)</i>		
JN086	Outside (in.)	Inside (in.)	Outside (mm)	Inside (mm)
1.8 lbs.	12 ³ / ₄ x 7 ¹ / ₂ x 1 ⁷ / ₈	11 x 7 x ³ / ₄	313 x 190 x 46	277 x 177 x 20
JN088	Outside (in.)	Inside (in.)	Outside (mm)	Inside (mm)
1.8 lbs.	12 ³ / ₄ x 7 ¹ / ₂ x 2 ¹ / ₂	11 x 7 x 1 ¹ / ₂	313 x 190 x 65	277 x 177 x 39
JN089	Outside (in.)	Inside (in.)	Outside (mm)	Inside (mm)
1.8 lbs.	12 ³ / ₄ x 7 ¹ / ₂ x 3 ⁵ / ₈	11 x 7 x 2 ¹ / ₂	313 x 190 x 92	277 x 177 x 66
JN090	Outside (in.)	Inside (in.)	Outside (mm)	Inside (mm)
1.9 lbs.	12 ³ / ₄ x 7 ¹ / ₂ x 5 ¹ / ₈	11 x 7 x 4	313 x 190 x 130	277 x 177 x 104

Quarter-Size Lid Only

Length x Width x Height (Inches and mm)

JN091	Outside (in.)	Outside (mm)
1.8 lbs.	12 ¹ / ₂ x 7 ¹ / ₂ x 1	319 x 190 x 25

Quarter-Size Container Baskets

Length x Width x Height (Inches)

<i>Length x Width x Height (Inches)</i>		<i>Length x Width x Height (mm)</i>		
JF264R	Outside (in.)	Inside (in.)	Outside (mm)	Inside (mm)
1.2 lbs.	10 ³ / ₄ x 7 x 1 ⁵ / ₈	10 ¹ / ₈ x 6 ⁵ / ₈ x 1 ³ / ₈	274 x 177 x 42	258 x 170 x 34

Quarter Size Perforated Basket with Lid and Silicone Cushioning Rack

JF282R	Outside (in.)	Inside (in.)	Outside (mm)	Inside (mm)
1.5 lbs.	10 ⁵ / ₈ x 6 ³ / ₄ x 3 ⁵ / ₈	10 ¹ / ₂ x 6 ⁵ / ₈ x 3 ¹ / ₂	270 x 171 x 93	267 x 169 x 91

JF289R	Outside (in.)	Outside (mm)
.6 lbs.	10 ³ / ₄ x 7 x ⁵ / ₈	273 x 177 x 16

Quarter Size Lid for tray JF282R

JG380R	Outside (in.)	Inside (in.)	Outside (mm)	Inside (mm)
.8 lbs.	10 ³ / ₄ x 3 ⁵ / ₁₆ x 1 ³ / ₁₆	10 ¹ / ₈ x 3 x 1 ¹ / ₁₆	273 x 84 x 30	257 x 76 x 27

Mini-Size perforated basket with lid and three instrument racks, two side by side will fit into JN088

JG381R	Outside (in.)	Inside (in.)	Outside (mm)	Inside (mm)
.8 lbs.	10 ³ / ₄ x 7 x 1 ³ / ₁₆	10 ¹ / ₈ x 6 ⁵ / ₈ x 1 ¹ / ₁₆	273 x 177 x 30	257 x 168 x 27

Quarter-Size perforated basket with lid

JG384R	Outside (in.)	Inside (in.)	Outside (mm)	Inside (mm)
.8 lbs.	10 ³ / ₄ x 7 x 1 ⁵ / ₈	10 ¹ / ₈ x 6 ⁵ / ₈ x 1 ¹ / ₂	273 x 177 x 41	257 x 168 x 38

Quarter-Size perforated basket with lid and three instrument racks, one JG381R and one JG384R can fit into JN089

MD374	Outside (in.)	Inside (in.)	Outside (mm)	Inside (mm)
.8 lbs.	10 ³ / ₄ x 7 x 1 ⁵ / ₈	10 ¹ / ₈ x 6 ⁵ / ₈ x 1 ³ / ₈	274 x 177 x 42	258 x 170 x 34

Quarter Size Perforated Basket with Lid and Silicone Cushioning Rack

*Basket height includes feet

Mini-Size Containers

<i>Length x Width x Height (Inches and mm)</i>			<i>Length x Width x Height (Inches and mm)</i>	
JN187	Bottom Only	.5 lbs.	Bottom and Aluminum Lid	
.9 lbs.	Inches	mm	Inches	mm
<i>Outside Dimension</i>	12 ¹ / ₄ x 5 ¹ / ₈ x 1 ¹ / ₈	310 x 132 x 30	12 ¹ / ₄ x 5 ¹ / ₂ x 1 ¹ / ₂	310 x 140 x 40
<i>Inside Dimension</i>			10 ³ / ₄ x 5 x 1 ¹ / ₄	274 x 126 x 33
JN188	Bottom Only	.6 lbs.	Bottom and Aluminum Lid	
1.0 lbs.	Inches	mm	Inches	mm
<i>Outside Dimension</i>	12 ¹ / ₄ x 5 ¹ / ₈ x 2 ¹ / ₄	310 x 132 x 57	12 ¹ / ₄ x 5 ¹ / ₂ x 2 ⁵ / ₈	310 x 140 x 67
<i>Inside Dimension</i>			10 ³ / ₄ x 5 x 2	274 x 126 x 50
JK187	Bottom Only	.4 lbs.	Bottom and Aluminum Lid	
.6 lbs.	Inches	mm	Inches	mm
<i>Outside Dimension</i>	12 ¹ / ₄ x 5 ¹ / ₈ x 1 ¹ / ₈	310 x 132 x 30	12 ¹ / ₄ x 5 ¹ / ₂ x 1 ¹ / ₂	310 x 140 x 40
<i>Inside Dimension</i>			10 ³ / ₄ x 5 x 1	274 x 126 x 25
JK188	Bottom Only	.6 lbs.	Bottom and Aluminum Lid	
.7 lbs.	Inches	mm	Inches	mm
<i>Outside Dimension</i>	12 ¹ / ₄ x 5 ¹ / ₈ x 2 ¹ / ₄	310 x 132 x 57	12 ¹ / ₄ x 5 ¹ / ₂ x 2 ⁵ / ₈	310 x 140 x 67
<i>Inside Dimension</i>			10 ³ / ₄ x 5 x 2	274 x 126 x 52

Mini-Size Container Baskets

<i>Length x Width x Height (Inches)</i>			<i>Length x Width x Height (mm)</i>	
JF159R	Outside (in.)	Inside (in.)	Outside (mm)	Inside (mm)
1.1 lbs.	10 ¹ / ₂ x 5 x 2	10 ¹ / ₄ x 4 ⁵ / ₈ x 1 ⁵ / ₈	267 x 125 x 49	261 x 118 x 41
JG380R	Outside (in.)	Inside (in.)	Outside (mm)	Inside (mm)
1.1 lbs.	10 ³ / ₄ x 3 ³ / ₈ x 1 ⁵ / ₈	10 ¹ / ₂ x 3 ¹ / ₈ x 1 ³ / ₈	273 x 84 x 41	267 x 77 x 33

NOTES:

¹ Inches rounded up to closest 1/8 inch.

SterilContainer™

System Product Dimensions

Extra-Long Containers				
Length x Width x Height (Inches and mm)			Length x Width x Height (Inches and mm)	
JN445	Bottom Only	7.3 lbs.	Bottom and Aluminum Lid	
8.1 lbs.	Inches	mm	Inches	mm
<i>Outside Dimension</i>	28 x 10 ³ / ₄ x 7 ³ / ₈	711 x 274 x 187	28 x 11 x 8	711 x 280 x 205
<i>Inside Dimension</i>			26 ¹ / ₄ x 10 ¹ / ₄ x 6 ¹ / ₄	667 x 261 x 160

Extra-Long Perforated Basket				
Length x Width x Height (Inches)			Length x Width x Height (mm)	
JF232R	Outside (in.)	Inside (in.)	Outside (mm)	Inside (mm)
2.4 lbs.	26 x 10 x 2 ¹ / ₄	25 ⁷ / ₈ x 9 ⁷ / ₈ x 1 ⁵ / ₈	662 x 254 x 56	658 x 251 x 42

Wide-Body containers				
Length x Width x Height (Inches)			Length x Width x Height (mm)	
JN817	Outside (in.)	Inside (in.)	Outside (mm)	Inside (mm)
6.6 lbs.	23 ⁵ / ₈ x 15 ³ / ₄ x 4 ³ / ₄	21 ¹ / ₂ x 13 ³ / ₄ x 3 ⁵ / ₈	600 x 400 x 120	544 x 350 x 91
JN821	Outside (in.)	Inside (in.)	Outside (mm)	Inside (mm)
7.7 lbs.	23 ⁵ / ₈ x 15 ³ / ₄ x 7	21 ¹ / ₂ x 13 ³ / ₄ x 6	600 x 400 x 180	544 x 350 x 151
JK817	Outside (in.)	Inside (in.)	Outside (mm)	Inside (mm)
6.2 lbs.	23 ⁵ / ₈ x 15 ³ / ₄ x 4 ³ / ₄	21 ¹ / ₂ x 13 ³ / ₄ x 4	600 x 400 x 120	544 x 350 x 103
JK821	Outside (in.)	Inside (in.)	Outside (mm)	Inside (mm)
7.3 lbs.	23 ⁵ / ₈ x 15 ³ / ₄ x 7	21 ¹ / ₂ x 13 ³ / ₄ x 6 ¹ / ₂	600 x 400 x 180	544 x 350 x 163

Wide-Body Baskets		
Length x Width x Height (Inches and mm)		
JF833R	Outside (in.)	Outside (mm)
3.8 lbs.	21 x 13 ¹ / ₄ x 3	540 x 344 x 74

*Basket height includes feet

SterilContainer™ S ₂				
Length x Width x Height (Inches and mm)			Length x Width x Height (Inches and mm)	
JS440	Bottom Only		Bottom and Aluminum Lid	
4.7 lbs.	Inches	mm	Inches	mm
<i>Outside Dimension</i>	23 ¹ / ₄ x 10 ³ / ₄ x 3 ¹ / ₂	592 x 274 x 90	23 ¹ / ₄ x 11 ¹ / ₄ x 4 ¹ / ₄	592 x 285 x 108
<i>Inside Dimension</i>			21 ¹ / ₂ x 10 ¹ / ₈ x 2 ¹ / ₂	544 x 258 x 63
JS441	Bottom Only		Bottom and Aluminum Lid	
5.1 lbs.	Inches	mm	Inches	mm
<i>Outside Dimension</i>	23 ¹ / ₄ x 10 ³ / ₄ x 4 ³ / ₄	592 x 274 x 120	23 ¹ / ₄ x 11 ¹ / ₄ x 5 ¹ / ₂	592 x 285 x 138
<i>Inside Dimension</i>			21 ¹ / ₂ x 10 ¹ / ₈ x 3 ⁵ / ₈	544 x 258 x 93
JS442	Bottom Only		Bottom and Aluminum Lid	
5.5 lbs.	Inches	mm	Inches	mm
<i>Outside Dimension</i>	23 ¹ / ₄ x 10 ³ / ₄ x 5 ¹ / ₄	592 x 274 x 135	23 ¹ / ₄ x 11 ¹ / ₄ x 6	592 x 285 x 153
<i>Inside Dimension</i>			21 ¹ / ₂ x 10 ¹ / ₈ x 4 ¹ / ₄	544 x 258 x 108
JS740	Bottom Only		Bottom and Aluminum Lid	
3.8 lbs.	Inches	mm	Inches	mm
<i>Outside Dimension</i>	18 ¹ / ₂ x 10 ³ / ₄ x 3 ¹ / ₂	470 x 274 x 90	18 ¹ / ₂ x 11 ¹ / ₄ x 4 ¹ / ₄	470 x 285 x 108
<i>Inside Dimension</i>			16 ¹ / ₄ x 10 ¹ / ₈ x 2 ¹ / ₂	421 x 258 x 63
JS741	Bottom Only		Bottom and Aluminum Lid	
4.3 lbs.	Inches	mm	Inches	mm
<i>Outside Dimension</i>	18 ¹ / ₂ x 10 ³ / ₄ x 4 ³ / ₄	470 x 274 x 120	18 ¹ / ₂ x 11 ¹ / ₄ x 5 ¹ / ₂	470 x 285 x 138
<i>Inside Dimension</i>			16 ¹ / ₄ x 10 ¹ / ₈ x 3 ⁵ / ₈	421 x 258 x 93
JS742	Bottom Only		Bottom and Aluminum Lid	
4.5 lbs.	Inches	mm	Inches	mm
<i>Outside Dimension</i>	18 ¹ / ₂ x 10 ³ / ₄ x 5 ¹ / ₄	470 x 274 x 135	18 ¹ / ₂ x 11 ¹ / ₄ x 6	470 x 285 x 153
<i>Inside Dimension</i>			16 ¹ / ₄ x 10 ¹ / ₈ x 4 ¹ / ₄	421 x 258 x 108
JS340	Bottom Only		Bottom and Aluminum Lid	
3.0 lbs.	Inches	mm	Inches	mm
<i>Outside Dimension</i>	11 ³ / ₄ x 10 ³ / ₄ x 3 ¹ / ₂	300 x 274 x 90	11 ³ / ₄ x 11 ¹ / ₄ x 4 ¹ / ₄	300 x 285 x 108
<i>Inside Dimension</i>			10 x 10 ¹ / ₈ x 2 ¹ / ₂	254 x 258 x 63
JS341	Bottom Only		Bottom and Aluminum Lid	
3.3 lbs.	Inches	mm	Inches	mm
<i>Outside Dimension</i>	11 ³ / ₄ x 10 ³ / ₄ x 4 ³ / ₄	300 x 274 x 120	11 ³ / ₄ x 11 ¹ / ₄ x 5 ¹ / ₂	300 x 285 x 138
<i>Inside Dimension</i>			10 x 10 ¹ / ₈ x 3 ⁵ / ₈	254 x 258 x 93
JS342	Bottom Only		Bottom and Aluminum Lid	
3.5 lbs.	Inches	mm	Inches	mm
<i>Outside Dimension</i>	11 ³ / ₄ x 10 ³ / ₄ x 5 ¹ / ₄	300 x 274 x 135	11 ³ / ₄ x 11 ¹ / ₄ x 6	300 x 285 x 153
<i>Inside Dimension</i>			10 x 10 ¹ / ₈ x 4 ¹ / ₄	254 x 258 x 108

Through collaborative excellence we will improve the quality of a patient's life and meet the needs of the changing healthcare environment.



Instructions For Use are located at
www.aesculapusaifus.com



Instructional videos on processing the
Aesculap SterilContainer™ System are located at
www.youtube.com/user/aesculapusa

Aesculap, Inc. - a member of the B. Braun Group of Companies
Center Valley, PA | 800-282-9000 | aesculapusa.com

Rx only. Confidential and Proprietary. ©2026 Aesculap, Inc. All rights reserved. 25-0458_05/26
DOC132