

Urology

| | |
|--|-----------|
| Needles | 1140 |
| Instruments for Radical Prostatectomy..... | 1141-1144 |
| Forceps & Clamps | 1145-1153 |
| Retractors | 1153-1155 |
| Catheters..... | 1156-1157 |

Urology

Needles



BM711R-BM714R



BM711R



BM712R



BM713R



BM714R



BM726R-BM729R



BM726R



BM727R



BM728R

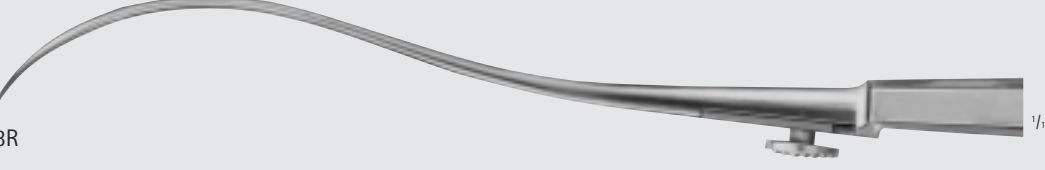

BM729R

REVERDIN Needle

| Catalog Number | Tip | Length (in.) |
|----------------|-----------|--------------|
| BM711R | SLT-CVD | 7 3/4 |
| BM712R | CVD | 7 3/4 |
| BM713R | HVY-CVD | 7 3/4 |
| BM714R | X-HVY-CVD | 7 3/4 |
| BM726R | SLT-CVD | 8 3/4 |
| BM727R | CVD | 8 3/4 |
| BM728R | HVY-CVD | 8 3/4 |
| BM729R | X-HVY-CVD | 8 3/4 |

■ For more information about BARRÉ Instruments for Radical Prostatectomy see our brochure number DOC737.

BARRÉ Scalpel Handle #3L, F/Blade nos. 10-15, 40, 42

| Catalog Number | Blade Shape | Blade | Length (in.) |
|----------------|-------------|-------|--------------|
| BB176R | ANG | 12° | 10 |



BARRÉ Scalpel Handle #3XL, F/Blade nos. 10-15, 40, 42

| Catalog Number | Blade | Length (in.) |
|----------------|-------|--------------|
| BB177R | STR | 10 |



BARRÉ Scalpel Handle #3XL, F/Blade nos. 10-15, 40, 42

| Catalog Number | Blade Shape | Blade | Length (in.) |
|----------------|-------------|-------|--------------|
| BB178R | ANG | 25° | 10 |

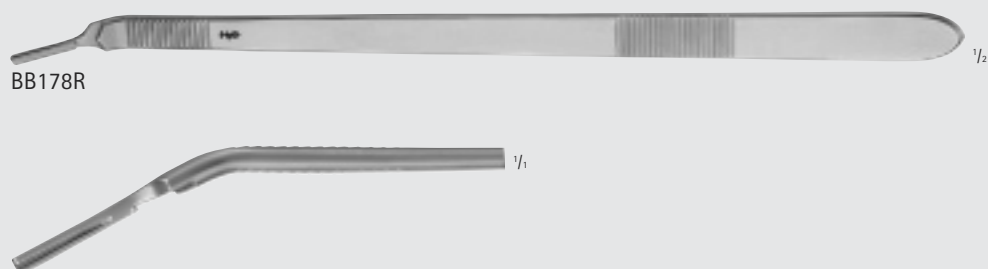

INCHES

Urology

BARRÉ Instruments for Radical Prostatectomy

BARRÉ Nerve Sparing Scissors

| Catalog Number | Tip | Blade | Length (in.) |
|----------------|-----|-------|--------------|
| BC715R | S/S | CVD | 11 |

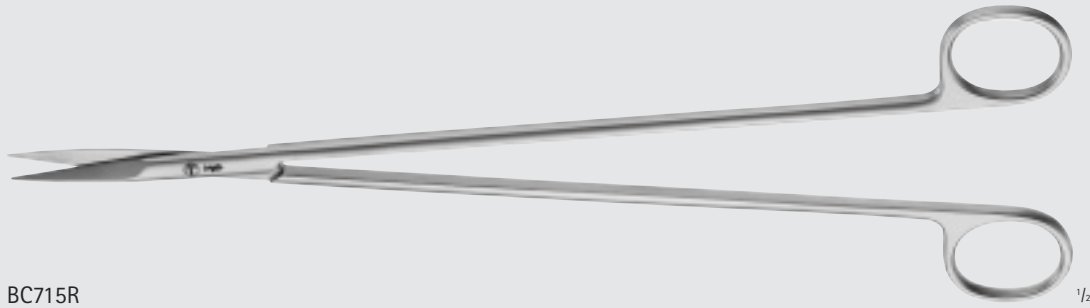

BC715R

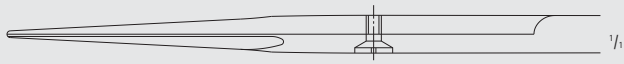

Dorsal Venous Complex Clamp

| Catalog Number | Blade | Length (in.) |
|----------------|-------|--------------|
| EF167R | 10° | 8 1/4 |



EF167R



UROL

BARRÉ Nerve Sparing Dissector

| Catalog Number | Tip | Length (in.) |
|----------------|--------|--------------|
| BJ029R | X-FINE | 11 |
| BJ110R | FINE | 11 |

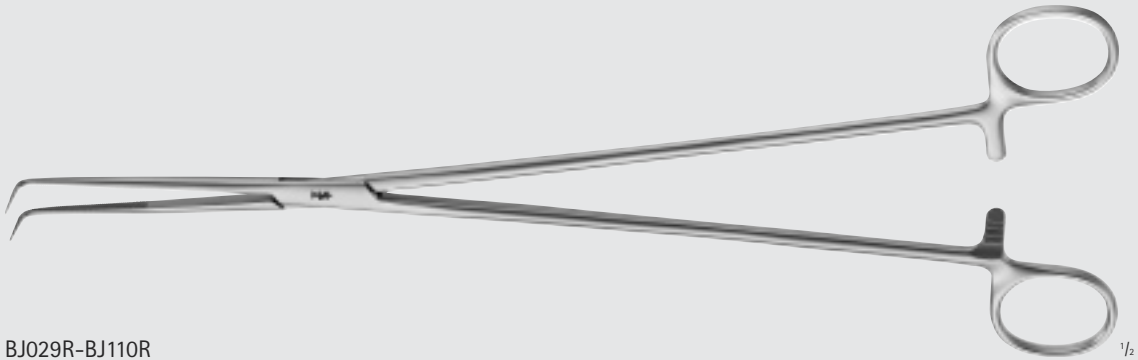

BJ029R-BJ110R



BJ029R



BJ110R

BARRÉ Prostate Retractor

| Catalog Number | Length (in.) |
|----------------|--------------|
| BT680R | 14 3/8 |

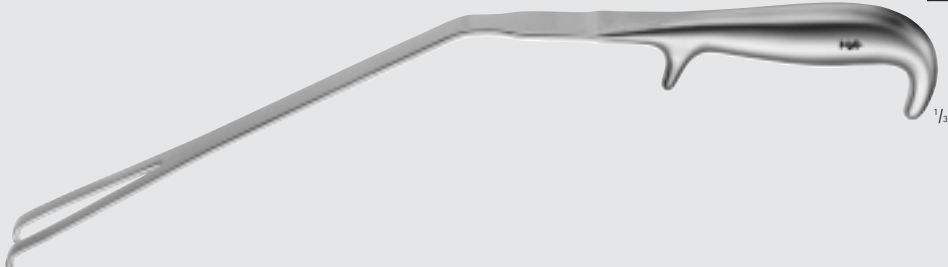

BT680R

BARRÉ Urethra Retractor

| Catalog Number | Length (in.) |
|----------------|--------------|
| BT681R | 15 1/2 |

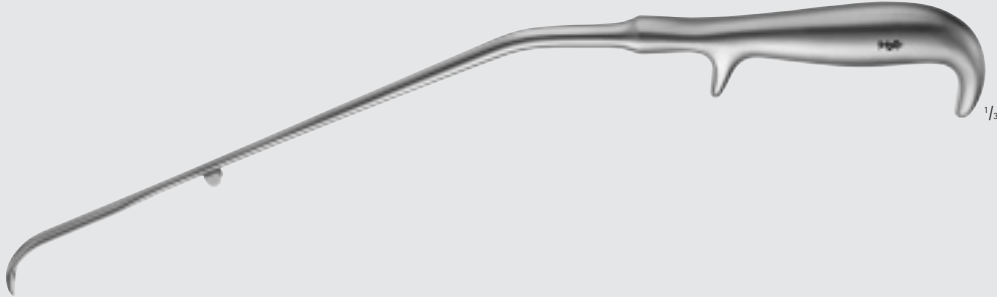

BT681R



UROL

Urology

BARRÉ Instruments for Radical Prostatectomy

BARRÉ Nerve/Tissue Sparing Bipolar Forceps, Bayonet Type

| Catalog Number | Length (in.) |
|----------------|--------------|
| GK685R | 10 1/4 |



GK685R

BARRÉ Suture Holding Frame

| Catalog Number | Length (in.) |
|----------------|--------------|
| BV927R | 18 1/3 |

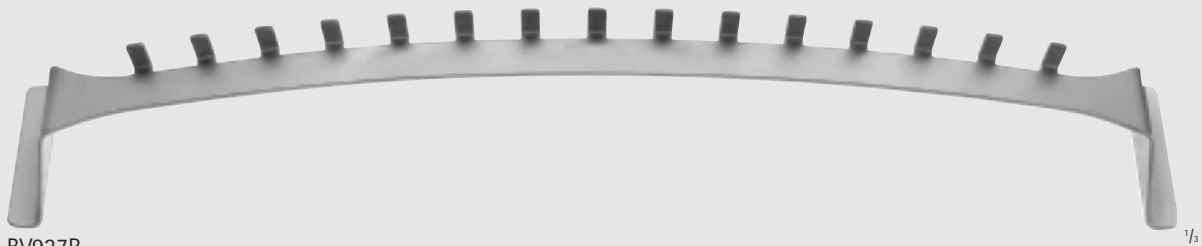

BV927R

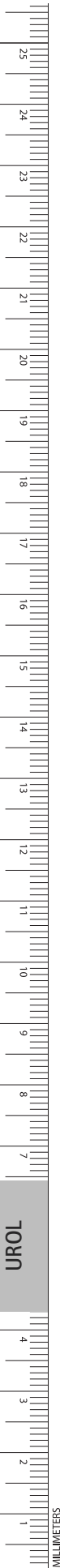
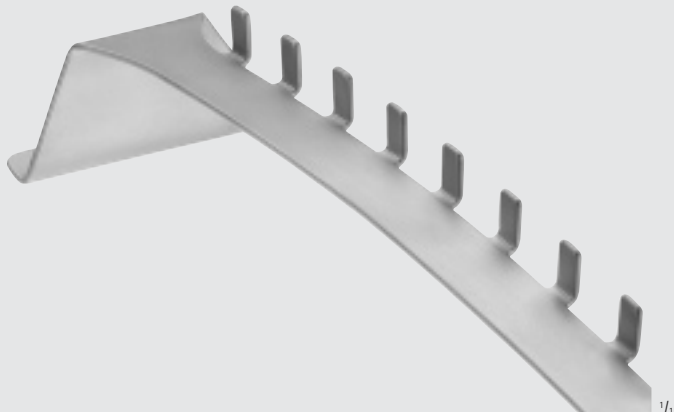

UROL

GUYON Atraumatic Kidney Clamp

| Catalog Number | Length (in.) |
|----------------|--------------|
| EF001R | 9 1/2 |
| EF002R | 9 |



EF001R-EF002R



EF001R

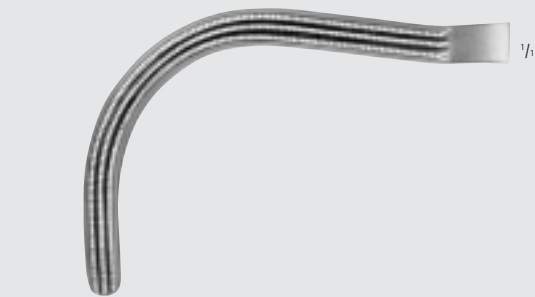

EF002R



INCHES

UROL

Urology

Forceps & Clamps



GUYON Kidney Clamp

| Catalog Number | Length (in.) |
|----------------|--------------|
| EF010R | 9 1/4 |
| EF011R | 9 |
| EF012R | 10 1/2 |

EF010R-EF012R

EF010R

EF011R

EF012R

STILLE Kidney Clamp

| Catalog Number | Length (in.) |
|----------------|--------------|
| EF015R | 9 1/2 |
| EF016R | 8 3/4 |

EF015R-EF016R

EF015R

EF016R

HERRICK Kidney Clamp

| Catalog Number | Length (in.) |
|----------------|--------------|
| EF030R | 9 |

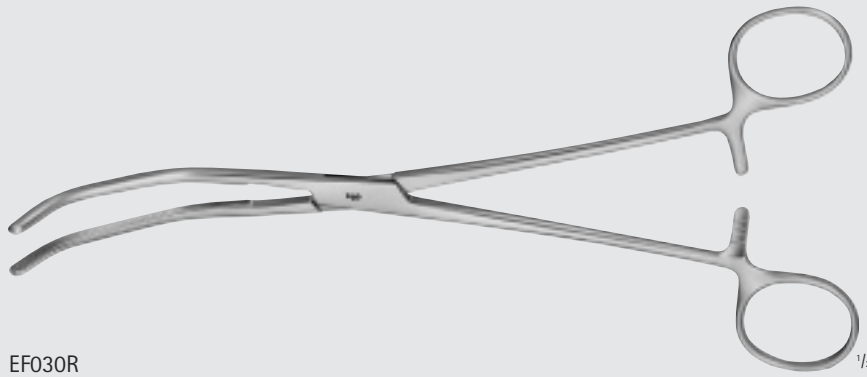

EF030R

1/2

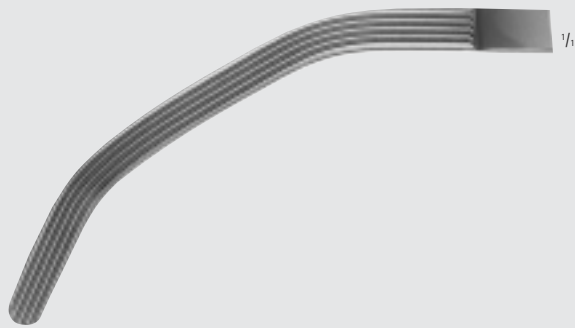

1/2

Ureter Atraumatic Forceps

| Catalog Number | Length (in.) |
|----------------|--------------|
| EF070R | 9 1/2 |

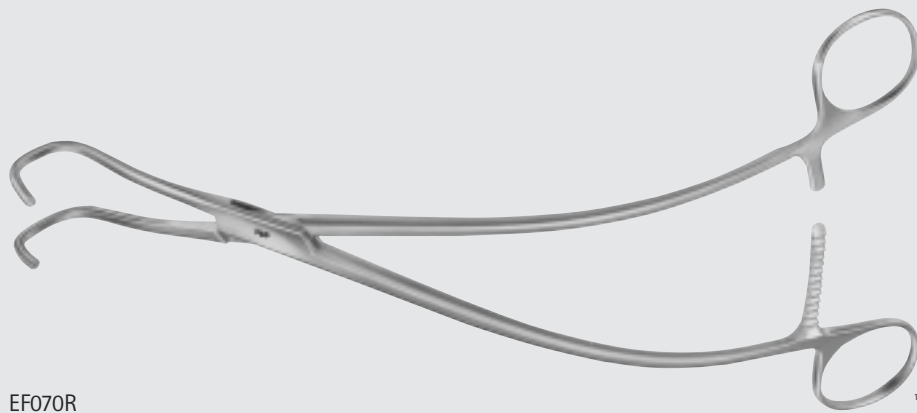

EF070R

1/2



1/2



UROLOGICAL

INCHES

Urology

Forceps & Clamps

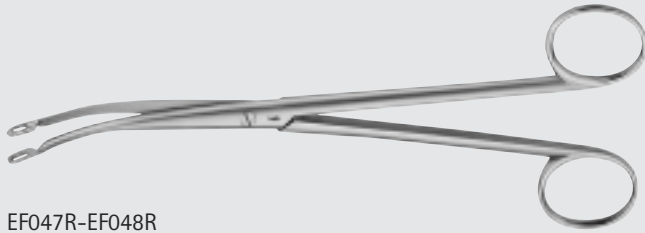

EF047R-EF048R



EF047R



EF048R

HEIMING Kidney Stone Forceps

| Catalog Number | Length (in.) |
|----------------|--------------|
| EF047R | 6 3/4 |
| EF048R | 6 1/4 |



UROL

RANDALL Kidney Stone Forceps

| Catalog Number | Jaw | Length (in.) |
|----------------|---------|--------------|
| EB246R | CVD | 9 |
| EF051R | SLT-CVD | 9 |
| EF052R | CVD | 9 |
| EF053R | HVY-CVD | 9 |
| EF054R | U-CVD | 9 |

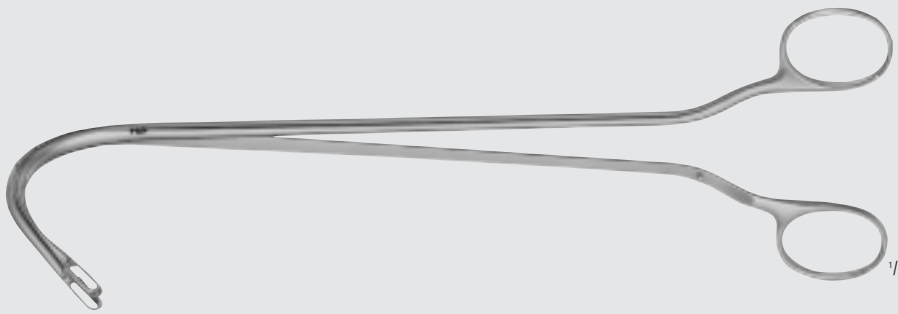

EB246R



EF051R-EF054R

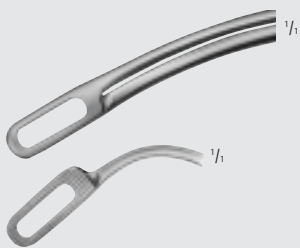

EF051R



EF052R



EF053R



EF054R



Urology

Forceps & Clamps

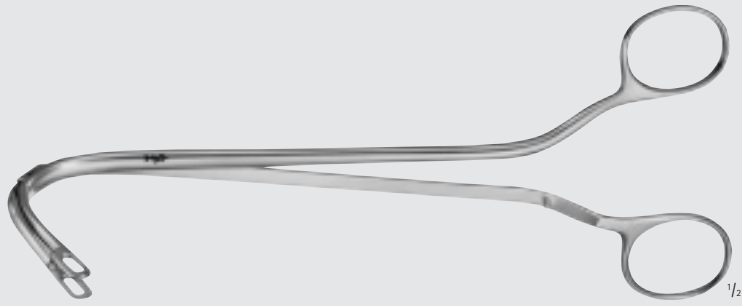

EF055R-EF056R



EF055R



EF056R

RANDALL Kidney Stone Forceps (continued)

| Catalog Number | Jaw | Length (in.) |
|----------------|---------|--------------|
| EF055R | CVD | 7 1/2 |
| EF056R | HVY-CVD | 7 1/2 |

UROL

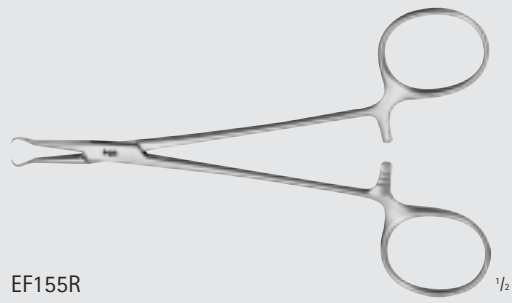

EF155R

Genitourinary Forceps

| Catalog Number | Length (in.) |
|----------------|--------------|
| EF155R | 5 |

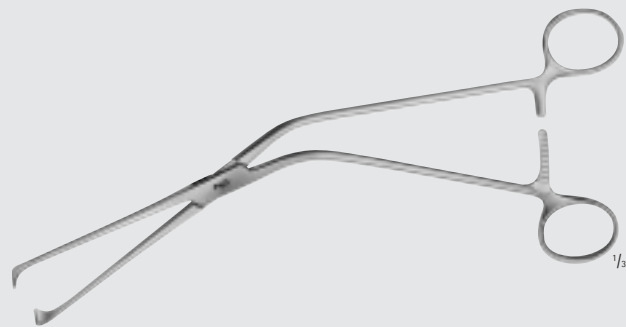

EF163R

MILLIN Atraumatic Lobe Forceps

| Catalog Number | Length (in.) |
|----------------|--------------|
| EF163R | 9 3/4 |

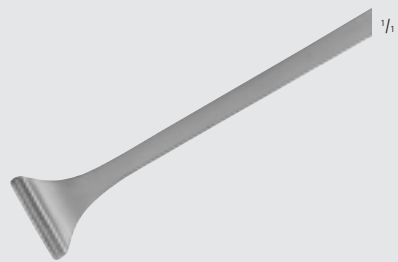

EF164R

MILLIN Atraumatic T-Shaped Lobe Forceps

| Catalog Number | Length (in.) |
|----------------|--------------|
| EF164R | 9 1/4 |

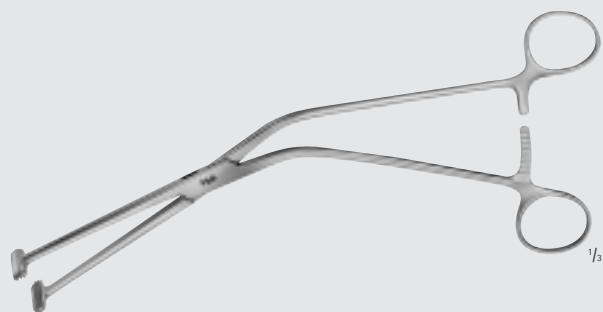

UROL

Urology

Forceps & Clamps

MATHIEU Foreign Body Forceps

| Catalog Number | Shaft Length (in.) |
|----------------|--------------------|
| EF928R | 7 1/2 |

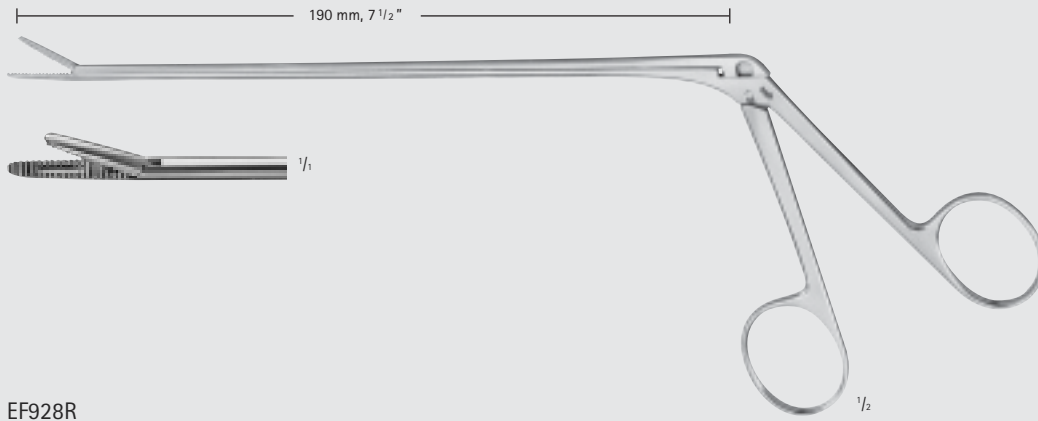

EF928R

STOCKMANN Penis Clamp

| Catalog Number | Length (in.) |
|----------------|--------------|
| EF400R | 2 3/4 |



EF400R

STRAUSS Penis Clamp

| Catalog Number | Length (in.) |
|----------------|--------------|
| EF401R | 5 1/8 |



EF401R



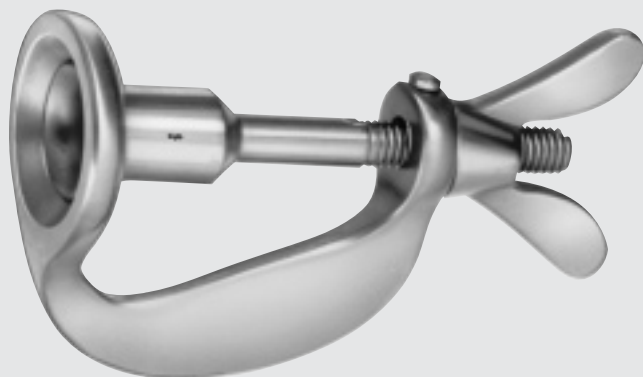

EF965R-EF967R

WINKELMANN Circumcision Clamp

| Catalog Number | Diameter (mm) |
|----------------|---------------|
| EF965R | 12 |
| EF966R | 16 |
| EF967R | 20 |

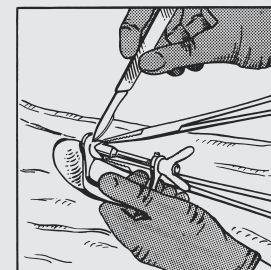
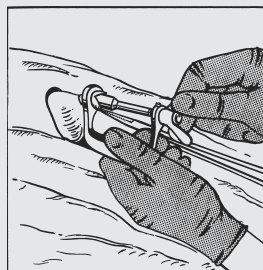

Assisted by two hemostats or ligatures the foreskin is pushed over the bell-shaped protection rod and the glans is placed into it. Next, the wing-nut is tightened as close as possible, so the foreskin is annular compressed. The foreskin is cut off with a scalpel adjacent to the compression ring. The circumcision clamp remains in place for a few minutes to avoid bleeding. If any large vein, specially the frenular artery, is cut, a ligature must be set. The advantage of the method described is the cosmetically favorable scar which is left after rejection of the small necrotized portion.



BV928R

LEGUEU Retractor

| Catalog Number | Blade Size (mm) | Length (in.) |
|----------------|-----------------|--------------|
| BV928R | 35 / 90 | 10 1/4 |



BV575R-BV580R

Bladder Retractor

| Catalog Number | Item |
|----------------|--------------------------|
| BV575R | SPREADER |
| BV576R | BLADES, 57 x 25MM |
| BV577R | BLADES, 82 x 25MM |
| BV578R | CENTER BLADE, 105 x 45MM |
| BV580R | COMPLETE |

BV580R Includes:
 1 Spreader BV575R
 1 Center Blade BV578R
 2 Blades of each BV576R and BV577R



INCHES

UROL

Urology

Abdominal Retractors

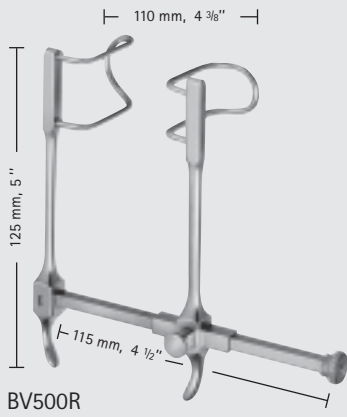

GOSSET Abdominal Retractor, Small

| Catalog Number | Blade Size (mm) |
|----------------|-----------------|
| BV500R | 38 |

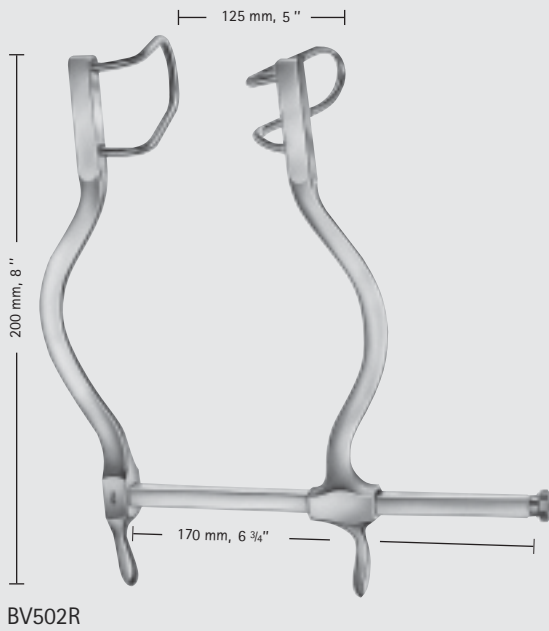

GOSSET Abdominal Retractor, Medium

| Catalog Number | Blade Size (mm) |
|----------------|-----------------|
| BV502R | 55 |

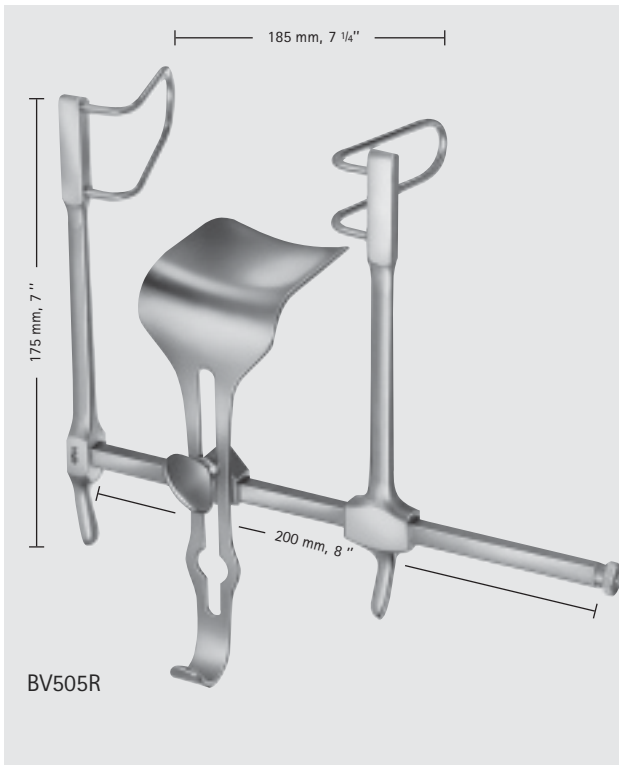

GOSSET Abdominal Retractor, Large

| Catalog Number | Item |
|----------------|------------------------------|
| BV505R | SET COMPLETE |
| BV506R | CENTER BLADE ONLY 59 x 57 MM |

BV505R Includes:
1 Center Blade BV506R

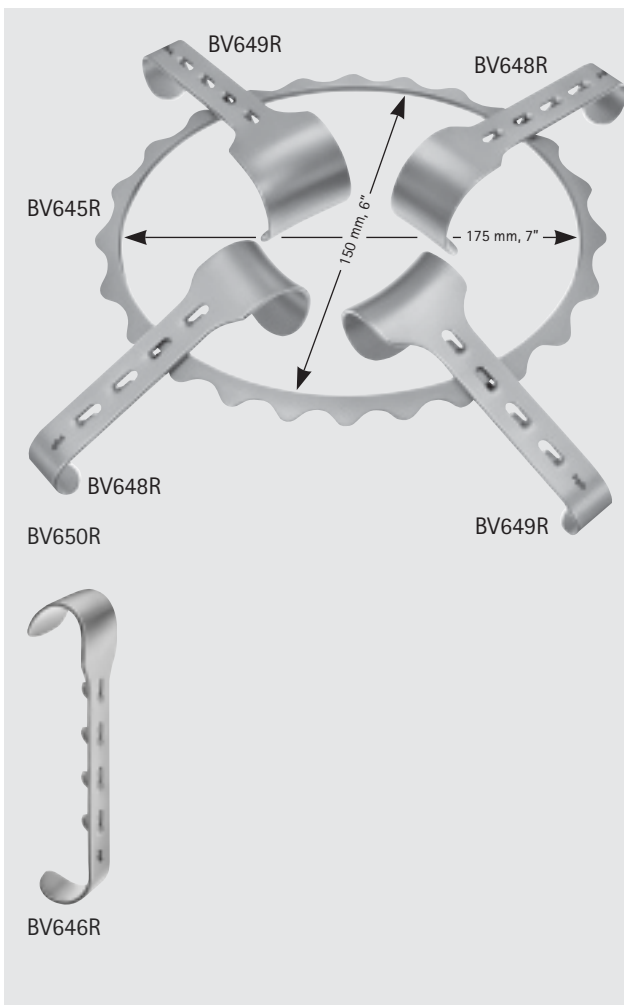

DENIS-BROWNE Abdominal Retractor

| Catalog Number | Item |
|----------------|--------------------------|
| BV650R | SET COMPLETE |
| BV645R | FRAME ONLY, 175 x 150MM |
| BV648R | 2 BLADES ONLY, 40 x 30MM |
| BV649R | 2 BLADES ONLY, 40 x 40MM |
| BV646R | BLADE ONLY, 20 x 30MM |
| BV647R | BLADE ONLY, 20 x 40MM |

BV650R Includes:
1 Frame BV645R
2 Blades of each BV648R and BV649R



UROL

INCHES

Urology

Catheters

Female Catheter, Metal

| Catalog Number | Tip Size (FR) | Length (in.) |
|----------------|---------------|--------------|
| EF306C | 6 | 6 |
| EF308C | 8 | 6 |
| EF310C | 10 | 6 |
| EF312C | 12 | 6 |
| EF314C | 14 | 6 |
| EF316C | 16 | 6 |
| EF318C | 18 | 6 |

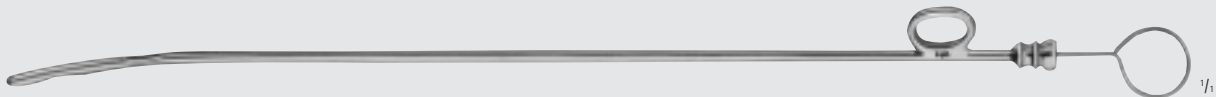

EF306C-EF318C

GUYON Wire Catheter Guide, Rigid

| Catalog Number | Blade | Length (in.) |
|----------------|-------|--------------|
| EF492R | CVD | 14 1/2 |

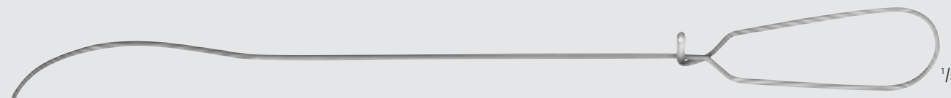

EF492R

DITTEL Urethral Sounds

| Catalog Number | Tip Size (FR) | Length (in.) |
|----------------|---------------|--------------|
| EF638R | 8 | 13 3/4 |
| EF639R | 9 | 13 3/4 |
| EF640R | 10 | 13 3/4 |
| EF641R | 11 | 13 3/4 |
| EF642R | 12 | 13 3/4 |
| EF643R | 13 | 13 3/4 |
| EF644R | 14 | 13 3/4 |
| EF645R | 15 | 13 3/4 |
| EF646R | 16 | 13 3/4 |
| EF647R | 17 | 13 3/4 |
| EF648R | 18 | 13 3/4 |
| EF649R | 19 | 13 3/4 |
| EF650R | 20 | 13 3/4 |
| EF651R | 21 | 13 3/4 |
| EF652R | 22 | 13 3/4 |
| EF653R | 23 | 13 3/4 |
| EF654R | 24 | 13 3/4 |
| EF655R | 25 | 13 3/4 |
| EF656R | 26 | 13 3/4 |
| EF657R | 27 | 13 3/4 |
| EF658R | 28 | 13 3/4 |
| EF659R | 29 | 13 3/4 |
| EF660R | 30 | 13 3/4 |

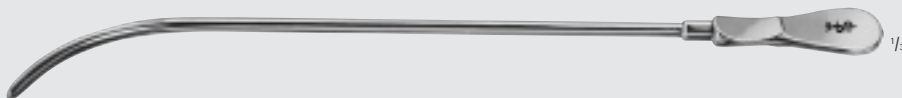

EF638R-EF660R

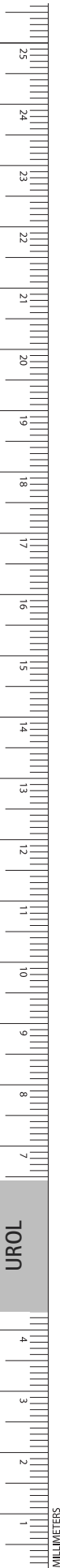

UROLOG

VAN BUREN Urethral Sounds

| Catalog Number | Tip Size (FR) | Length (in.) |
|----------------|---------------|--------------|
| EF800R | 8 | 10 5/8 |
| EF801R | 10 | 10 5/8 |
| EF802R | 12 | 10 5/8 |
| EF803R | 14 | 10 5/8 |
| EF804R | 16 | 10 5/8 |
| EF805R | 18 | 10 5/8 |
| EF806R | 20 | 10 5/8 |
| EF807R | 22 | 10 5/8 |
| EF808R | 24 | 10 5/8 |
| EF809R | 26 | 10 5/8 |
| EF810R | 28 | 10 5/8 |
| EF811R | 30 | 10 5/8 |
| EF812R | 32 | 10 5/8 |
| EF813R | 34 | 10 5/8 |
| EF814R | 36 | 10 5/8 |
| EF815R | 38 | 10 5/8 |
| EF816R | 40 | 10 5/8 |

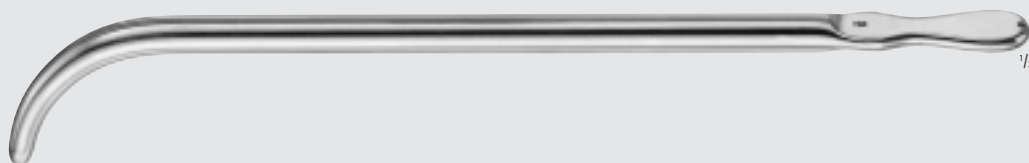

EF800R-EF816R



