

# Aesculap® SQ.line® Surgical Instruments

Reinventing Surgical Instruments



Aesculap Surgical Instruments

**AESCULAP®**

# Aesculap® SQ.line® Surgical Instruments

Our Motivation | Your Solution

High quality surgical instruments should perform as an extension of a surgeon's hand. As the world's largest supplier in surgical instruments, Aesculap continues to raise the bar for how OR grade surgical instruments perform. Superior Quality (SQ) line sets the new standard for surgical instruments.

Designed with the end user in mind, SQ.line surgical instrument enhancements go beyond performance in the OR. SQ.line surgical instruments offer improvements in ergonomics, sterilization capabilities, grip, repair options and design capabilities compared to competitor products in the market. Also, with 200+ patterns, SQ.line surgical instruments are a complete product line that will be able to service all basic instrumentation in your orthopedic surgical cases.

**100%**  
STAINLESS STEEL



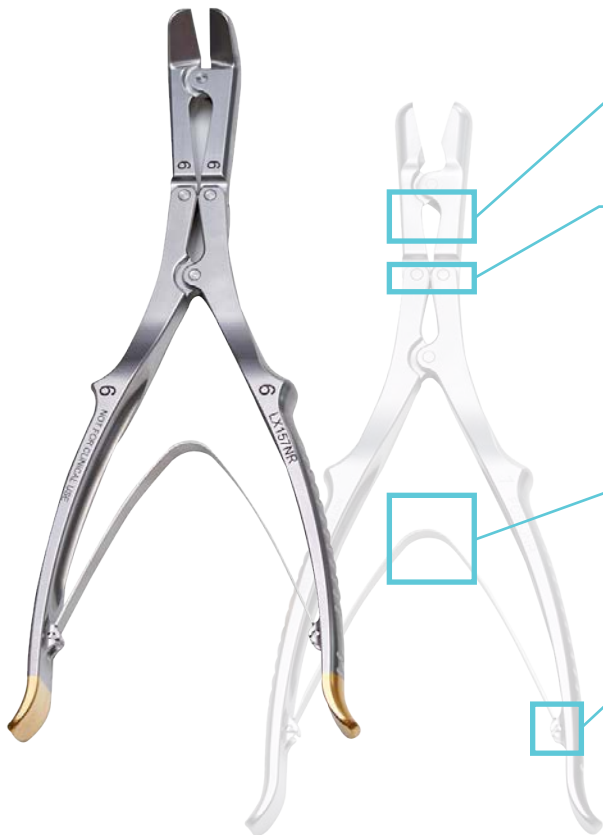

**50% REDUCTION**

In difficult to inspect areas.\*

**INTERCHANGABLE JAWS**

Allow for more effective repairs, reducing repair costs.

**21% LESS FORCE**

Needed than competitors.\*

**ONE PIECE SCREW**

Eliminates possibility of accidental openings.

\*

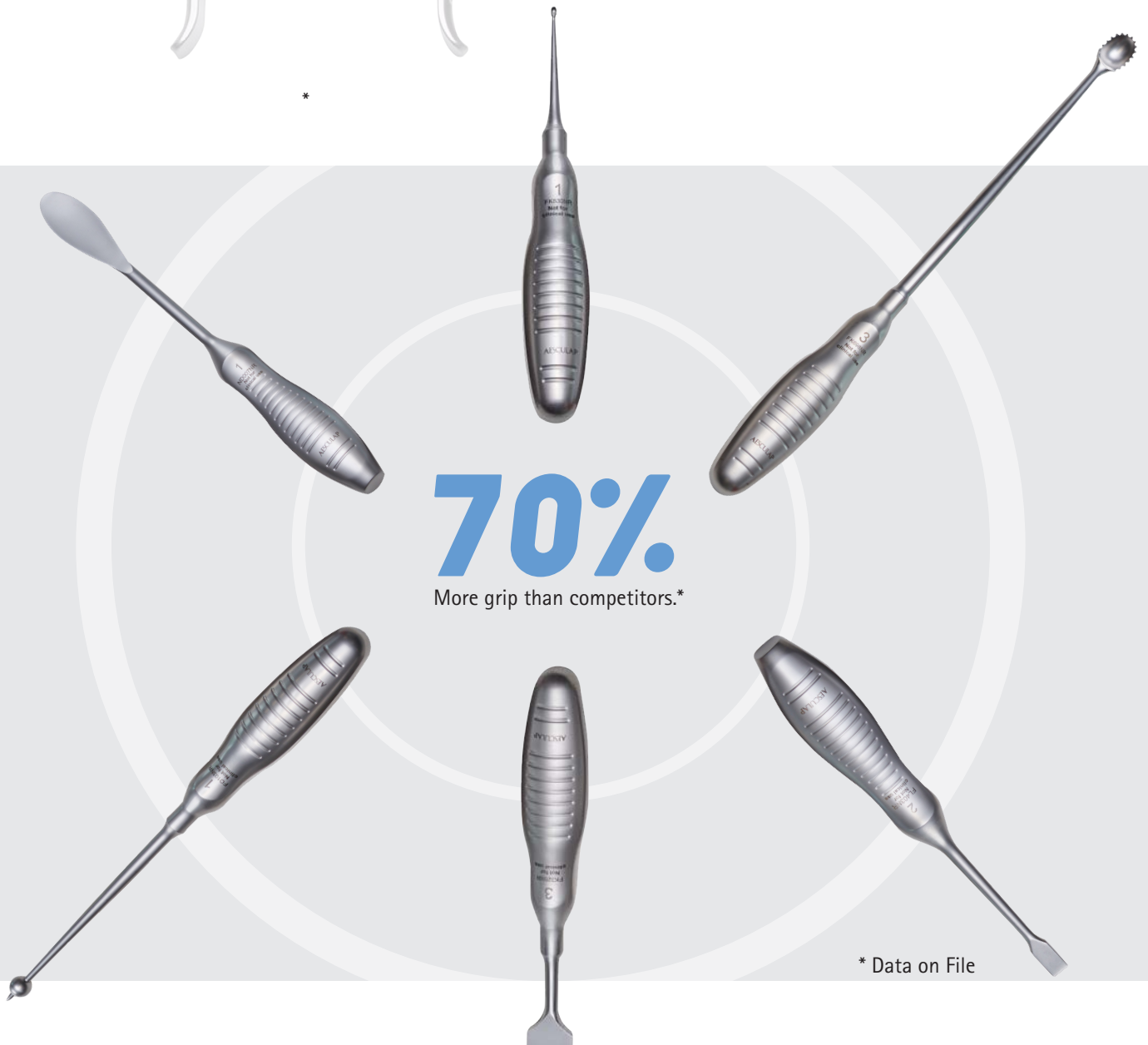

**70%**

More grip than competitors.\*

\* Data on File

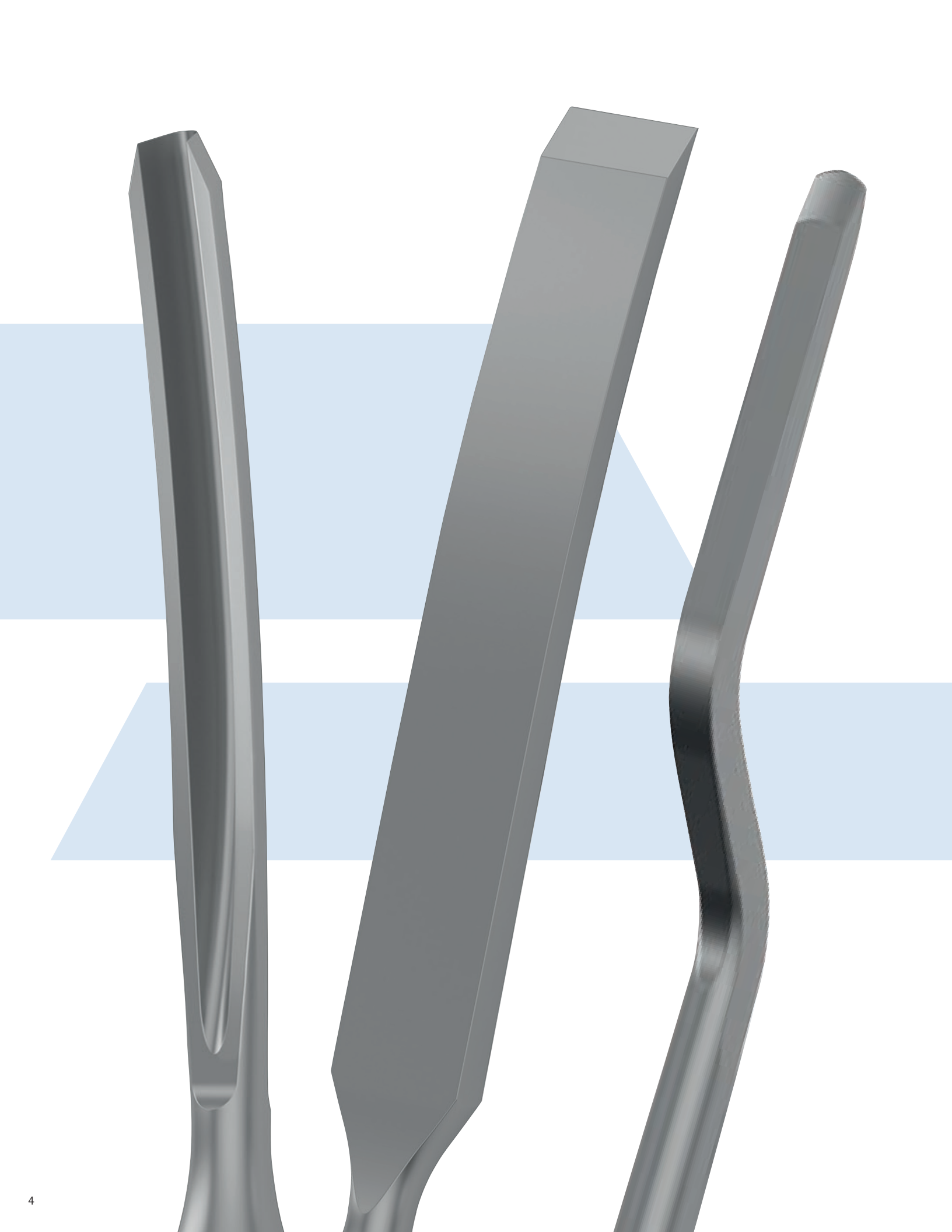

# Table of Contents

1. Mallets	6-8
2. Osteotomes	9-10,19
3. Gouges	11-12,15
4. Chisels	13
5. "Swan Neck" Chisel, Extraction Instrument for Prostheses Stems	14
6. Chisels for Cement Removal	16-17
7. Cement Extractors	18
8. Bone Rongeurs	20-23
9. Bone Cutting Forceps	24
10. Curettes	25-27
11. Raspatories	28-30
12. Luxation Lever	31
13. Bone Hook, Drill	32
14. Ball Spikes	33
15. Wire Guides	34
16. Extraction Pliers	35
17. Wire Cutters	36
18. Tampers	37
19. Retractor, Retractor Blades	38
20. Numerical Index	39



# Aesculap® SQ.line® Surgical Instruments

## Mallets

■ Weight refers to the head weight of the respective mallet.



**FL046211**

Spare disc,  
diam. 30 mm  
metal convex



**FL046212**

Spare disc,  
diam. 30 mm  
plastic convex



**FL046213**

Spare disc,  
diam. 30 mm  
metal concave



**FL046214**

Spare disc,  
diam. 30 mm  
plastic concave



**FL046NR** 330 g 235 mm, 9 1/4"

with:

FL046211 Spare disc metal convex  
FL046212 Spare disc plastic convex  
FL062206 Wrench



**FL057NR** 380 g

240 mm, 9 1/2"



**FL066NR** 580 g

245 mm, 9 5/8"

# Aesculap® SQ.line® Surgical Instruments

## Mallets

- Weight refers to the head weight of the respective mallet.



1/2

**FL062211**

Spare disc, diam. 35 mm  
metal convex



1/2

**FL062212**

Spare disc, diam. 35 mm  
plastic convex



1/2

**FL062213**

Spare disc, diam. 35 mm  
metal concave

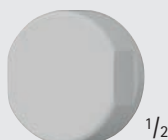

1/2

**FL062214**

Spare disc, diam. 35 mm  
plastic concave



530 g

Diam.  
35 mm

FL062NR  
CE

AESCULAP®

1/2

WAGNER

**FL062NR** 530 g 240 mm, 9 1/2"

with:

FL062211 Spare disc metal convex

FL062212 Spare disc plastic convex

FL062206 Wrench



zu FL062NR  
FL062R

AESCULAP®  
FL062NR

zu FL062NR  
FL062R

1/2

**FL062206**

Wrench  
for FL046NR and FL062NR  
for changing the spare  
discs



780 g

Diam.  
43 mm

FL069NR  
CE

AESCULAP®

1/2

**FL069NR** 780 g

245 mm, 9 5/8"



MILLIMETERS

# Aesculap® SQ.line® Surgical Instruments

## Mallets

- Weight refers to the head weight of the respective mallet.

Mallet with slot KH113NR among other applicable with cement extractors

ND079R-ND081R, ND089R..... 18

cement extractor hooks

ND082R-ND084R ..... 18



**KH113NR** 680 g

Mallet with slot  
280 mm, 11"



**MB631NR** 660 g

225 mm, 8 7/8"

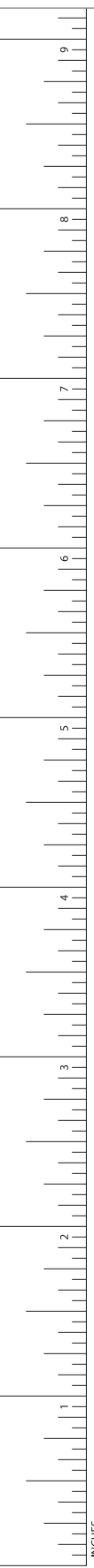



# Aesculap® SQ.line® Surgical Instruments

## Osteotomes



LEXER

Art. No.	Width
FL400NR	4 mm
FL401NR	6 mm
FL402NR	8 mm
FL403NR	10 mm
FL405NR	15 mm
FL406NR	20 mm
FL407NR	25 mm
FL408NR	30 mm

240 mm, 9 1/2"



LEXER

Art. No.	Width
FL820NR	4 mm
FL821NR	6 mm
FL822NR	8 mm
FL823NR	10 mm
FL825NR	15 mm
FL826NR	20 mm
FL827NR	25 mm
FL828NR	30 mm

300 mm, 11 3/4"



Osteotomes

FL920NR-FL927NR

to be used with cross bar

ND078R ..... 16

LEXER

Art. No.	Width
FL920NR	4 mm
FL922NR	8 mm
FL925NR	15 mm
FL927NR	25 mm

400 mm, 15 3/4"

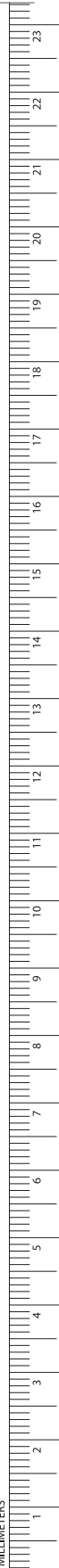

MILLIMETERS

# Aesculap® SQ.line® Surgical Instruments

## Osteotomes

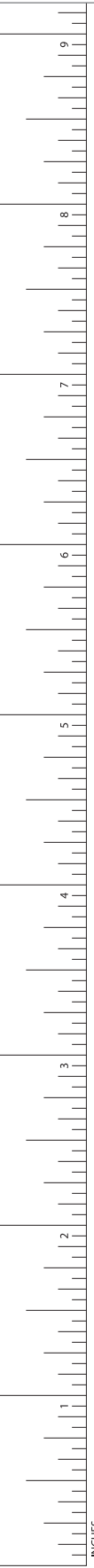

LEXER  
ND108NR  
angled  
300 mm, 11 3/4"



LEXER  
ND109NR  
angled  
300 mm, 11 3/4"

# Aesculap® SQ.line® Surgical Instruments

## Gouges



LEXER

Art. No.	Width
FL410NR	4 mm
FL411NR	6 mm
FL412NR	8 mm
FL413NR	10 mm
FL415NR	15 mm
FL416NR	20 mm
FL417NR	25 mm
FL418NR	30 mm

240 mm, 9 1/2"



LEXER

Art. No.	Width
FL830NR	4 mm
FL831NR	6 mm
FL832NR	8 mm
FL833NR	10 mm
FL835NR	15 mm
FL836NR	20 mm
FL837NR	25 mm
FL838NR	30 mm

300 mm, 11 3/4"



# Aesculap® SQ.line® Surgical Instruments

## Gouges

Gouges FL930NR-FL937NR  
to be used with cross bar  
ND078R ..... 16

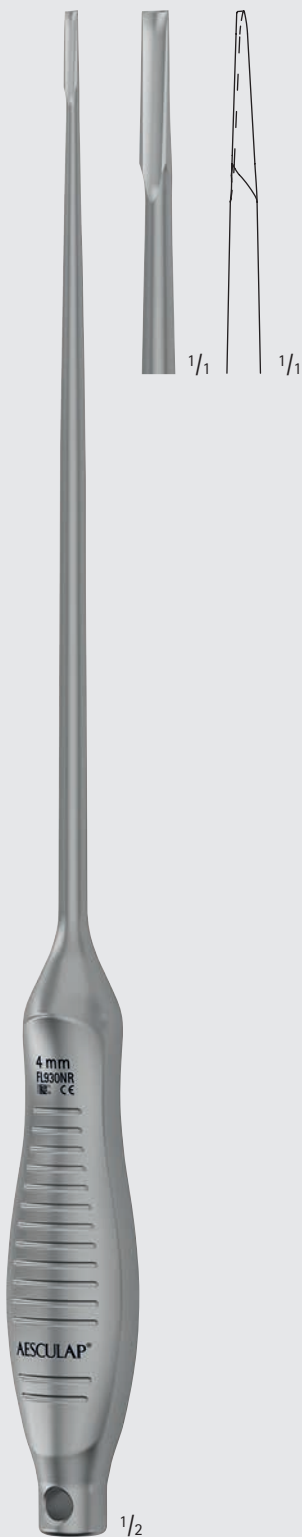

LEXER

Art. No.	Width
FL930NR	4 mm
FL932NR	8 mm
FL935NR	15 mm
FL937NR	25 mm

400 mm, 15 3/4"



Art. No.	Width
FL441NR	5 mm
FL443NR	10 mm
FL445NR	15 mm

Cancellous bone gouges, curved  
240 mm, 9 1/2"

# Aesculap® SQ.line® Surgical Instruments

## Chisels

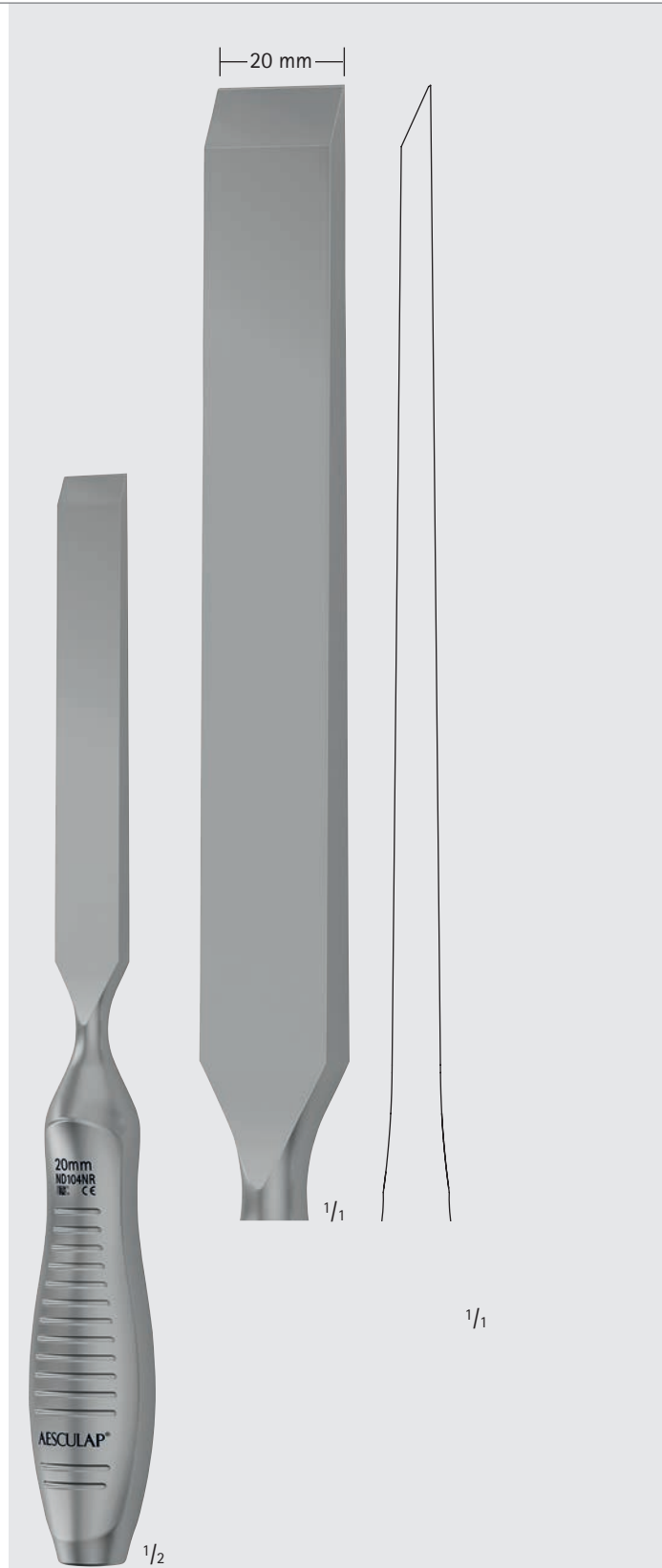

**ND104NR**

straight  
300 mm, 11 3/4"

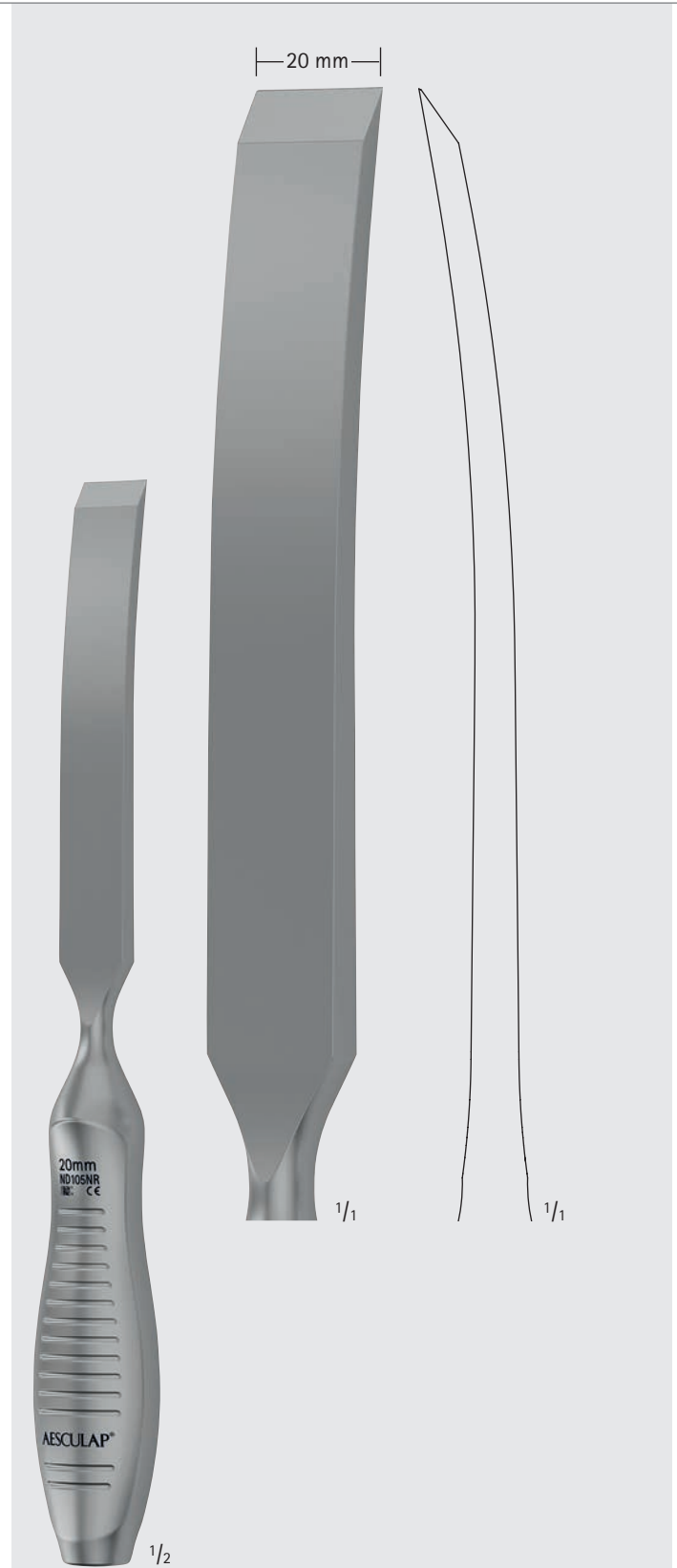

**ND105NR**

curved  
300 mm, 11 3/4"



MILLIMETERS

# Aesculap® SQ.line® Surgical Instruments

"Swan Neck" Chisel, Extraction Instrument For Prostheses Stems

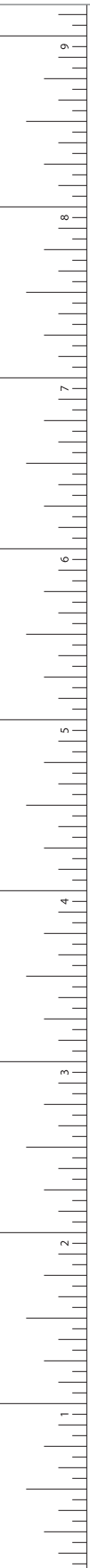

**ND118NR**  
"Swan neck" chisel  
300 mm, 11 3/4"



**ND376NR**  
Extraction instrument  
for prostheses stems  
300 mm, 11 3/4"

# Aesculap® SQ.line® Surgical Instruments

## Gouges

Gouges ND091NR-ND098NR to be used  
with cross bar ND078R ..... 16

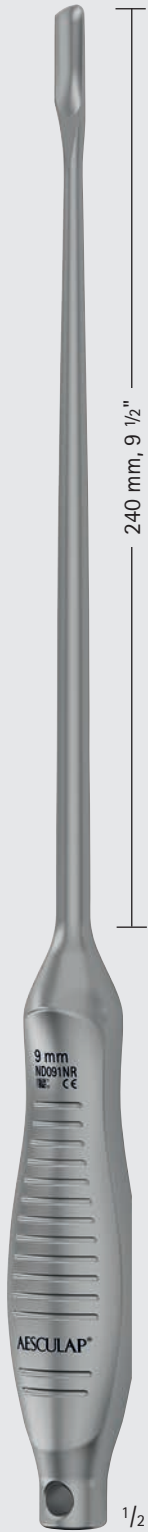

WAGNER

ND091NR-ND098NR

400 mm, 15 3/4"

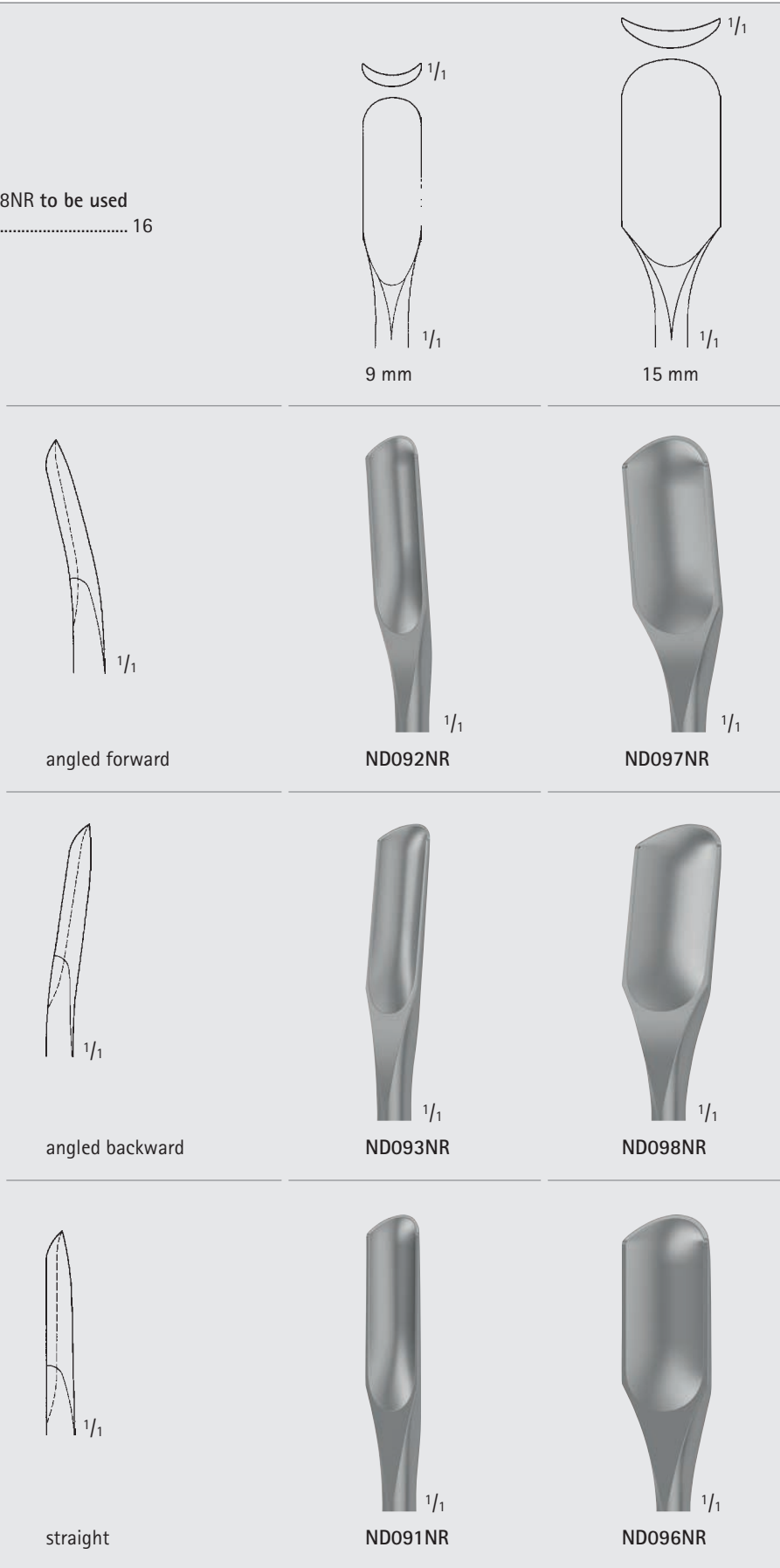

MILLIMETERS

# Aesculap® SQ.line® Surgical Instruments

## Chisels for Cement Removal

Chisels ND066NR-ND068NR  
to be used with  
cross bar ND078R ..... 21

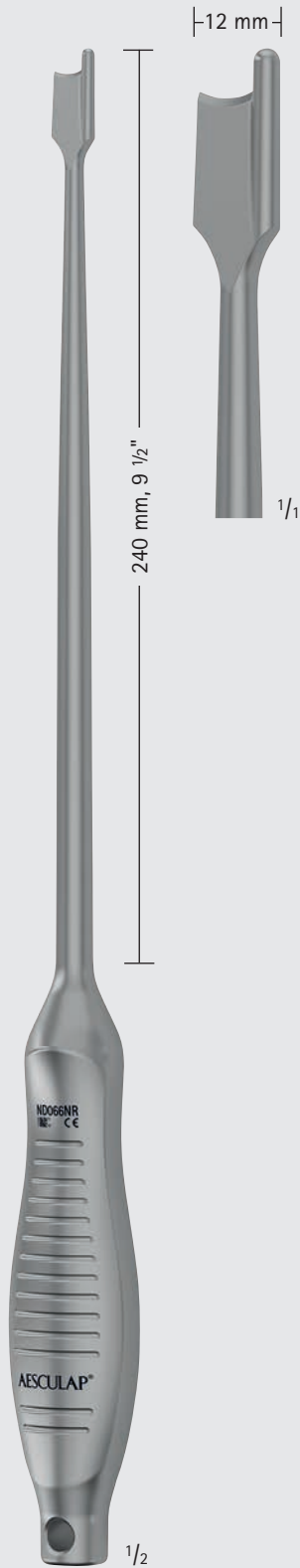

**ND066NR**

straight,  
chamfered  
400 mm, 15 3/4"

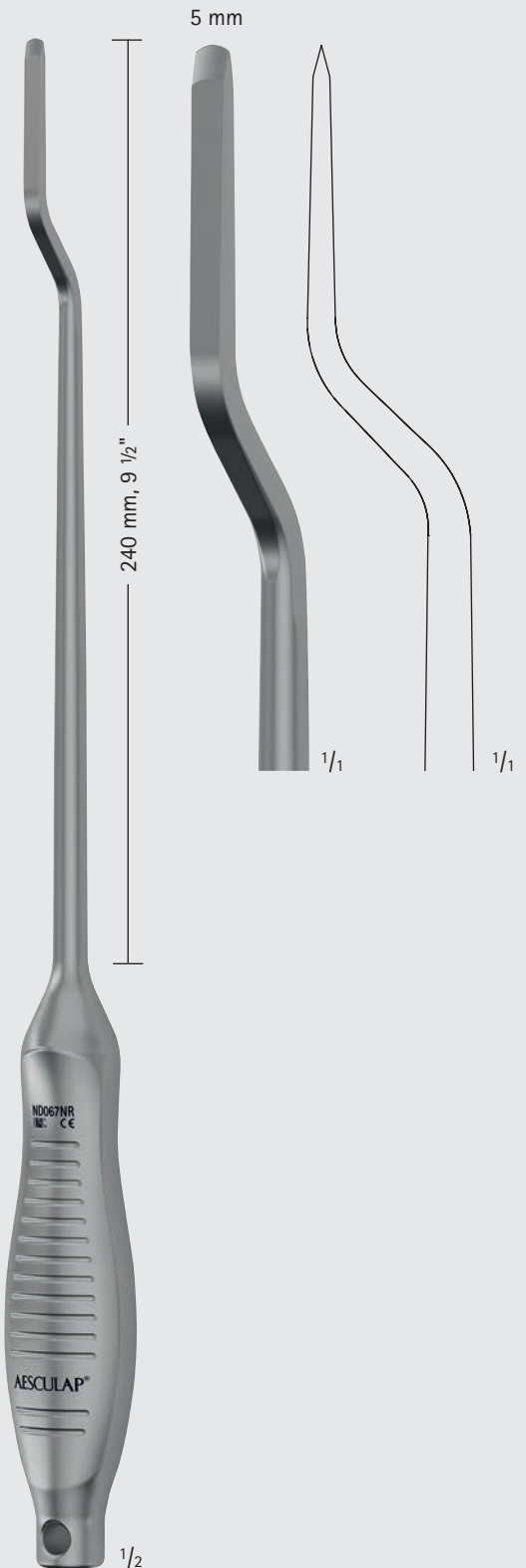

**ND067NR**

bayonet-shaped  
400 mm, 15 3/4"



# Aesculap® SQ.line® Surgical Instruments

## Chisels for Cement Removal

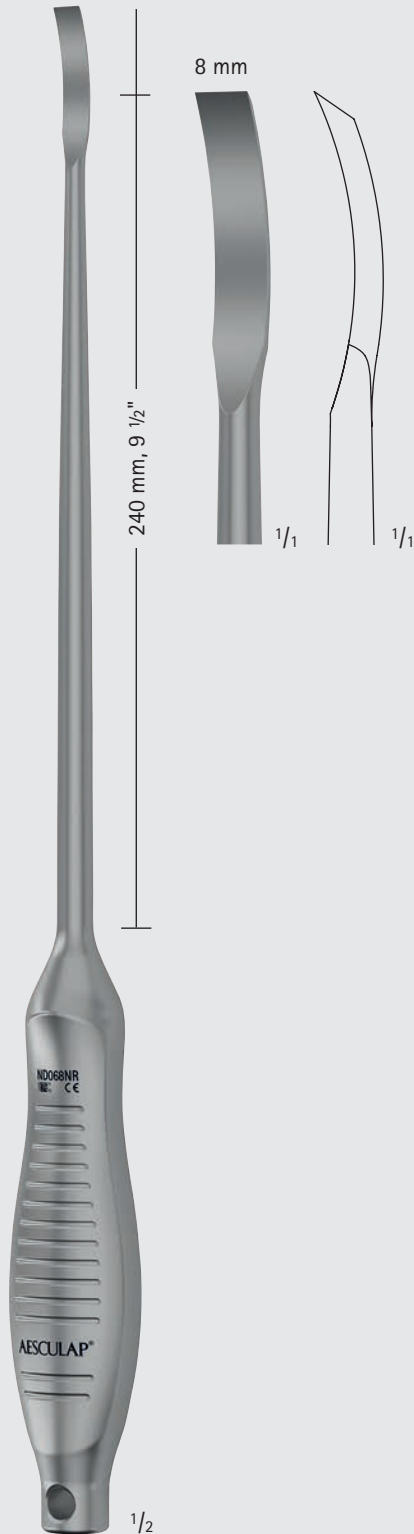

**ND068NR**

curved  
400 mm, 15 3/4"

Cross bar ND078R for use  
with osteostomes:

FL920NR-FL927NR ..... 17

with chisels:

FL930NR-FL937NR ..... 12

with gouges:

ND066NR-ND068NR ..... 17, 16

ND091NR-ND098NR ..... 15

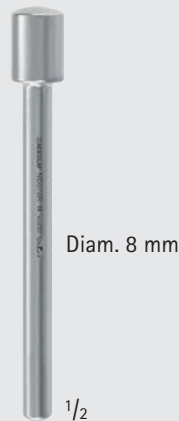

**ND078R**

Cross bar  
110 mm, 4 1/4"

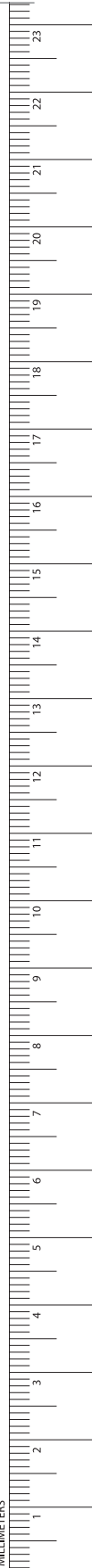

# Aesculap® SQ.line® Surgical Instruments

## Cement Extractors, Cement Extractor Hooks

Mallet with slot  
 KH113NR .....8  
 with cement extractors  
 ND079R-ND081R, ND089R and  
 cement extractor hooks ND082R-ND084R



Art. No.	Tip size diam.	Shaft diam.
ND079R	8 mm	6 mm
ND080R	10 mm	6 mm
ND081R	12 mm	6 mm
ND089R	14 mm	6 mm

Cement extractors with thread  
 525 mm, 20 3/4"



Art. No.	Blade width	Shaft diam.
ND082R	6 mm	6 mm
ND083R	8 mm	6 mm
ND084R	10 mm	6 mm

Cement extractor hooks  
 530 mm, 20 7/8"

# Aesculap® SQ.line® Surgical Instruments

## Osteotomes



LAMBOTTE

Art. No.	Width
FL650R	4 mm
FL663R	6 mm
FL651R	8 mm
FL652R	10 mm
FL653R	13 mm
FL654R	15 mm
FL655R	18 mm
FL656R	20 mm
FL658R	25 mm
FL659R	30 mm
FL660R	40 mm
FL662R	50 mm

straight  
240 mm, 9 1/2"



LAMBOTTE

Art. No.	Width
FL800R	4 mm
FL813R	6 mm
FL801R	8 mm
FL802R	10 mm
FL804R	15 mm
FL806R	20 mm
FL808R	25 mm
FL809R	30 mm
FL810R	40 mm
FL812R	50 mm

straight  
300 mm, 11 3/4"

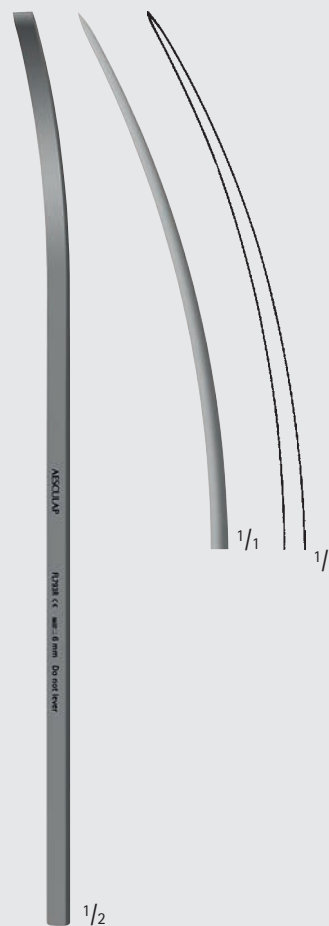

LAMBOTTE

Art. No.	Width
FL793R	6 mm
FL781R	8 mm
FL782R	10 mm
FL783R	15 mm
FL785R	20 mm
FL788R	25 mm
FL789R	30 mm
FL790R	40 mm

curved  
240 mm, 9 1/2"



MILLIMETERS

# Aesculap® SQ.line® Surgical Instruments

## Bone Rongeurs

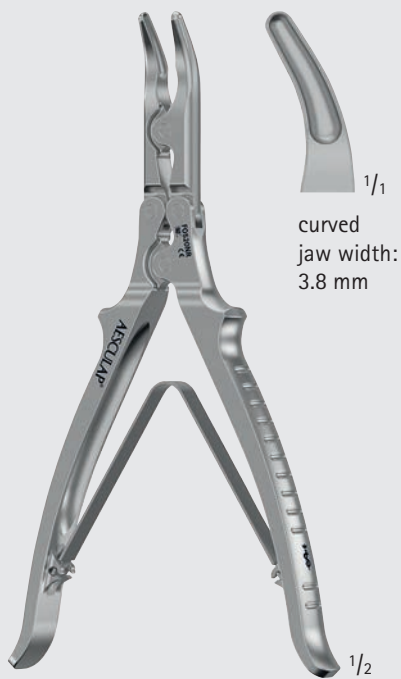
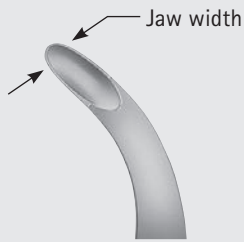

LUER

**FO520NR**

delicate pattern  
180 mm, 7"

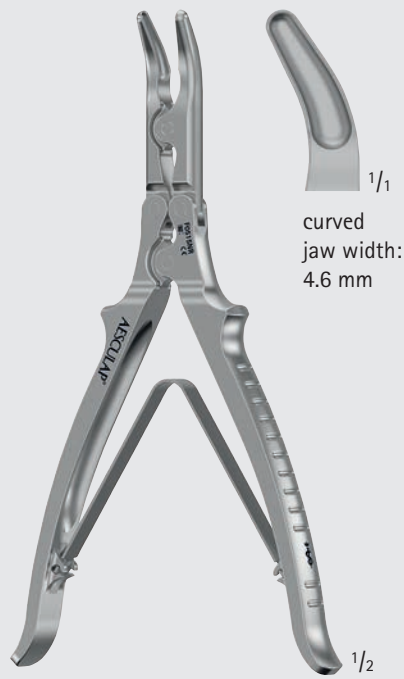

LUER

**FO515NR**

medium pattern  
180 mm, 7"

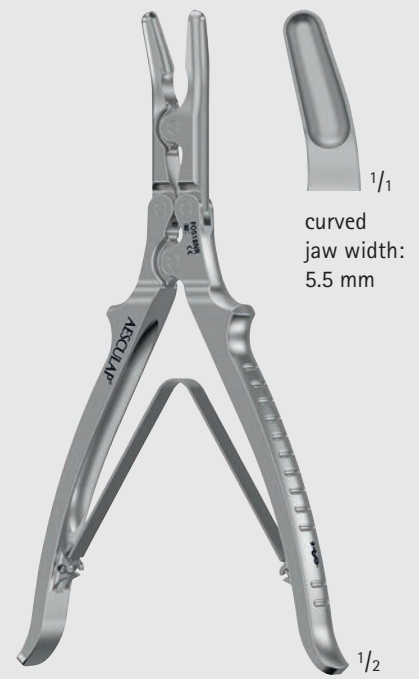

LUER

**FO518NR**

strong pattern  
180 mm, 7"

# Aesculap® SQ.line® Surgical Instruments

## Bone Rongeurs

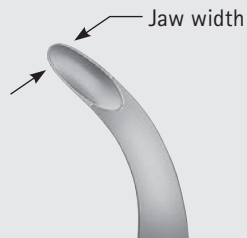

LUER

**FO516NR**

delicate pattern  
240 mm, 9 1/2"



LUER

**FO517NR**

medium pattern  
240 mm, 9 1/2"



LUER

**FO521NR**

strong pattern  
240 mm, 9 1/2"



MILLIMETERS

# Aesculap® SQ.line® Surgical Instruments

## Bone Rongeurs

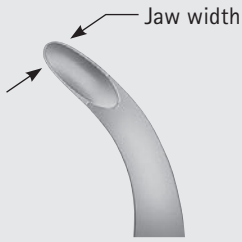

angled to side  
jaw width:  
6.8 mm

LUER-STILLE

**FO530NR**

very strong pattern  
240 mm, 9 1/2"



straight  
jaw width:  
8 mm

LUER-STILLE

**FO532NR**

very strong pattern  
240 mm, 9 1/2"



curved  
jaw width:  
8 mm

LUER-STILLE

**FO534NR**

very strong pattern  
240 mm, 9 1/2"

# Aesculap® SQ.line® Surgical Instruments

## Bone Rongeurs

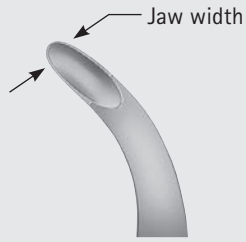

straight  
jaw width:  
10.6 mm

LUER-STILLE

**FO550NR**

extra strong pattern  
240 mm, 9 1/2"

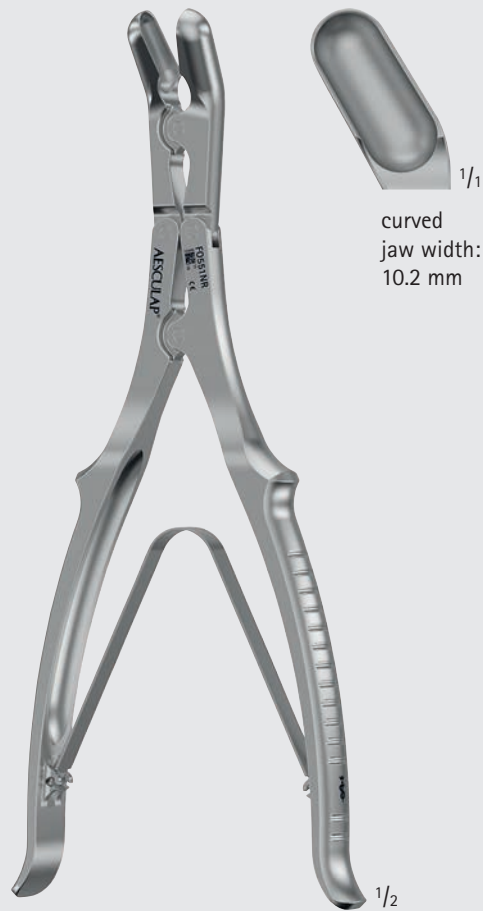

curved  
jaw width:  
10.2 mm

LUER-STILLE

**FO551NR**

extra strong pattern  
240 mm, 9 1/2"



# Aesculap® SQ.line® Surgical Instruments

## Bone Cutting Forceps

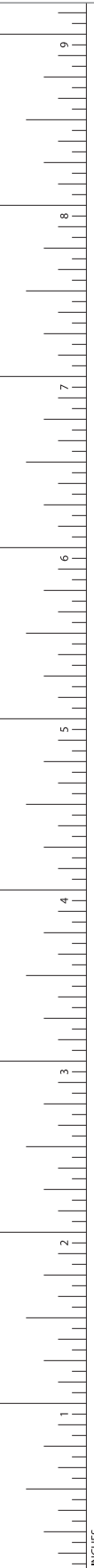

angled,  
30 mm cutting edge

LISTON  
FO645NR  
240 mm, 9 1/2"



angled,  
22 mm cutting edge

RUSKIN-LISTON  
FO641NR  
180 mm, 7"



# Aesculap® SQ.line® Surgical Instruments

## Curettes

2.8 mm



FK630NR

3.6 mm



FK631NR

4.4 mm



FK632NR

5.2 mm



FK633NR

6.8 mm



FK634NR

8.5 mm



FK635NR

10 mm

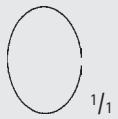

FK636NR

11.5 mm

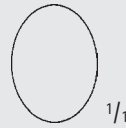

FK637NR

13 mm

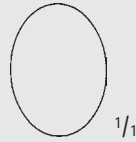

FK638NR

14.5 mm

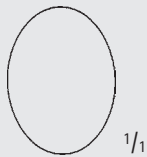

FK639NR



1/2

VOLKMANN

FK630NR-FK639NR

180 mm, 7"

2.8 mm



FK640NR

3.6 mm



FK641NR

4.4 mm



FK642NR

5.2 mm



FK643NR

6.8 mm



FK644NR

8.5 mm



FK645NR

10 mm

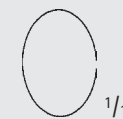

FK646NR

11.5 mm

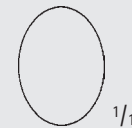

FK647NR

13 mm



FK648NR



1/1

1/1

14.5 mm

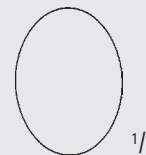

FK649NR



1/2

VOLKMANN

FK640NR-FK649NR

240 mm, 9 1/2"

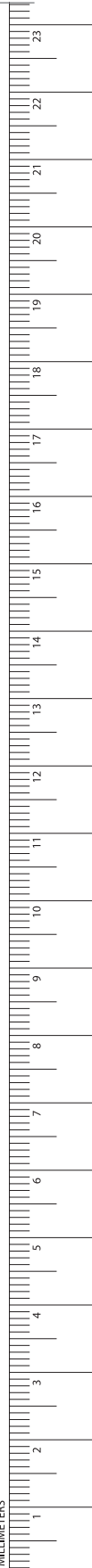

MILLIMETERS

# Aesculap® SQ.line® Surgical Instruments

## Curettes

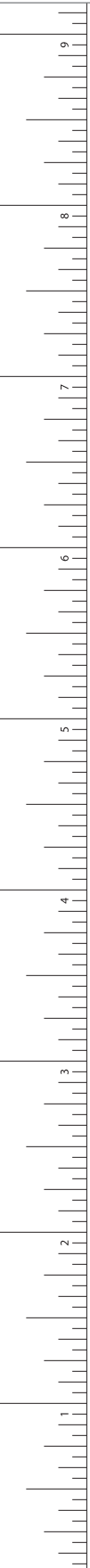

5.2 mm  
FK743NR

8.5 mm  
FK745NR

11.5 mm  
FK747NR

VOLKMANN  
FK743NR-FK747NR  
300 mm, 11 3/4"

5.2 mm  
FK753NR

8.5 mm  
FK755NR

11.5 mm  
FK757NR

VOLKMANN  
FK753NR-FK757NR  
400 mm, 15 3/4"

# Aesculap® SQ.line® Surgical Instruments

## Curettes



Art. No.	Width
FK696NR	9 mm
FK698NR	15 mm
300 mm, 11 3/4"	



ND019NR  
300 mm, 11 3/4"



# Aesculap® SQ.line® Surgical Instruments

## Raspatories

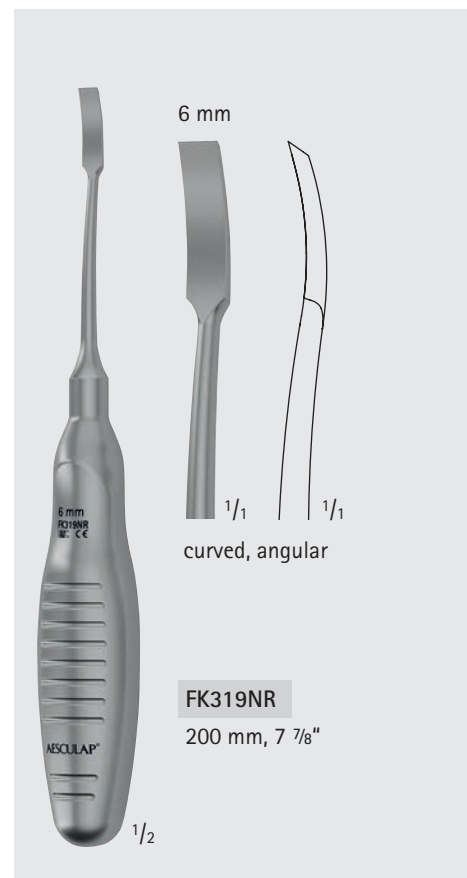
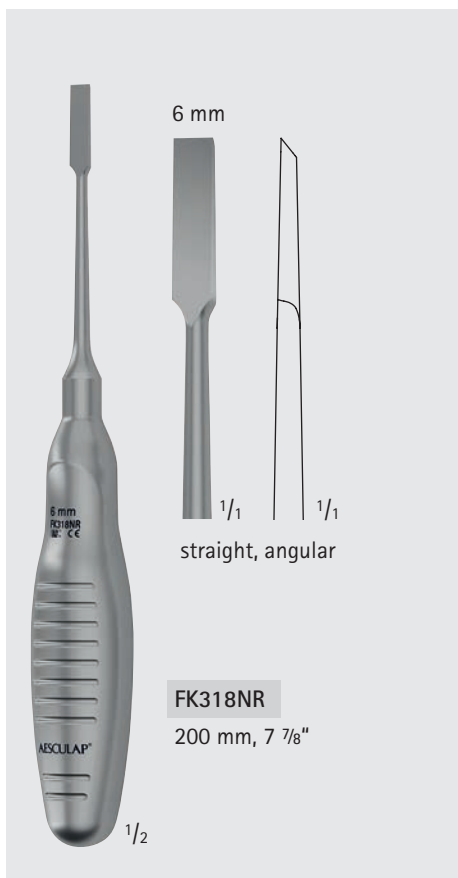
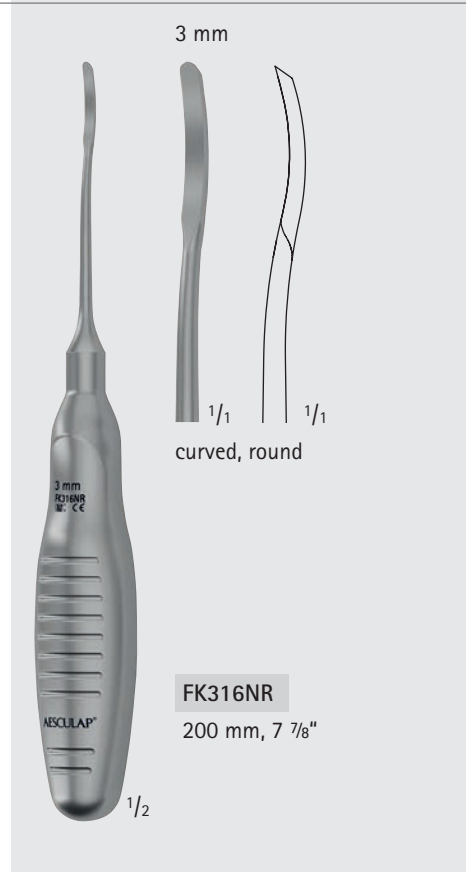
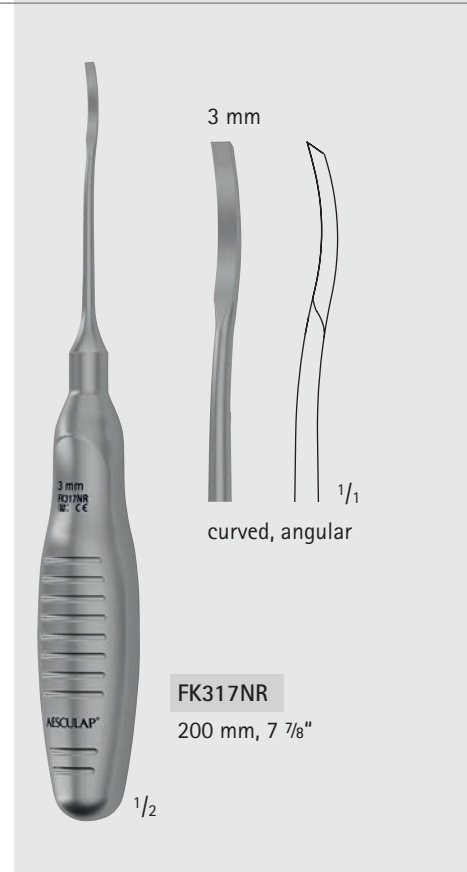
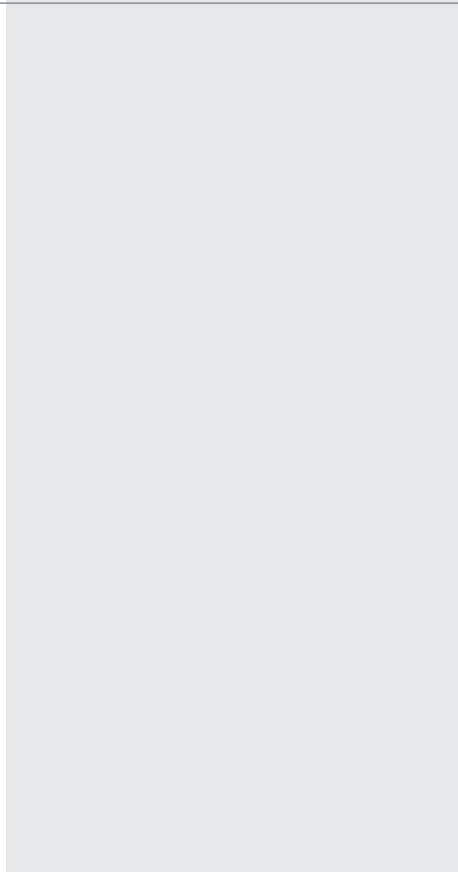
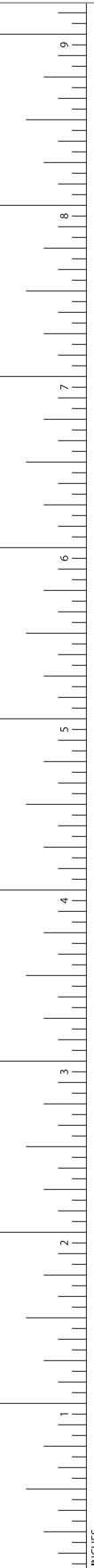

# Aesculap® SQ.line® Surgical Instruments

## Raspatories

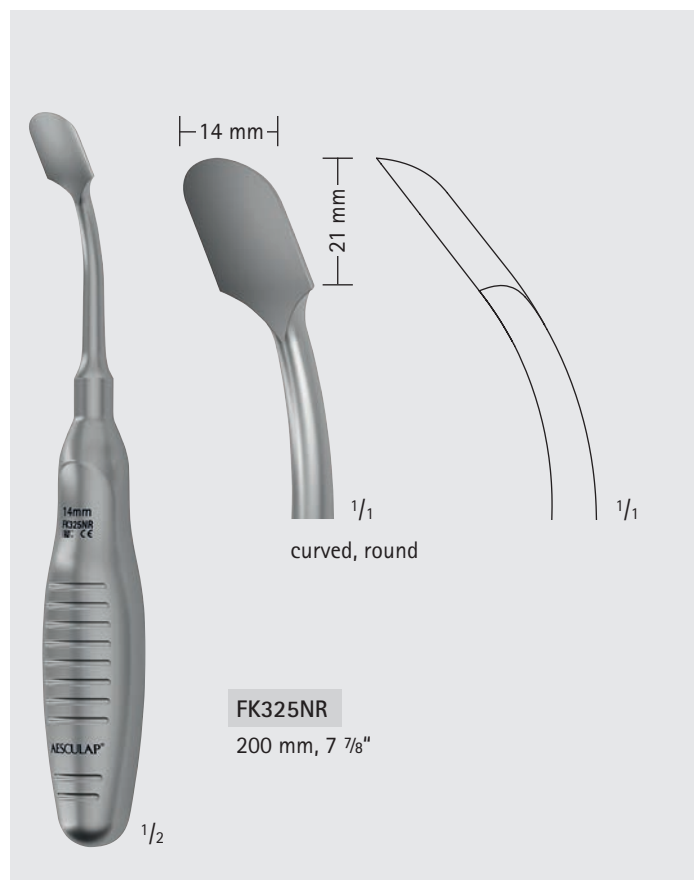
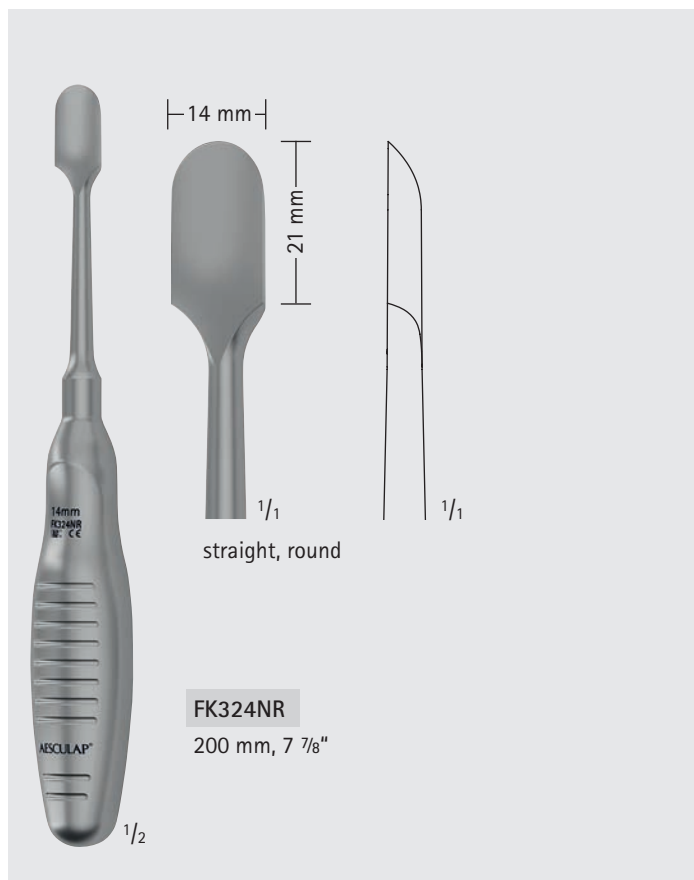
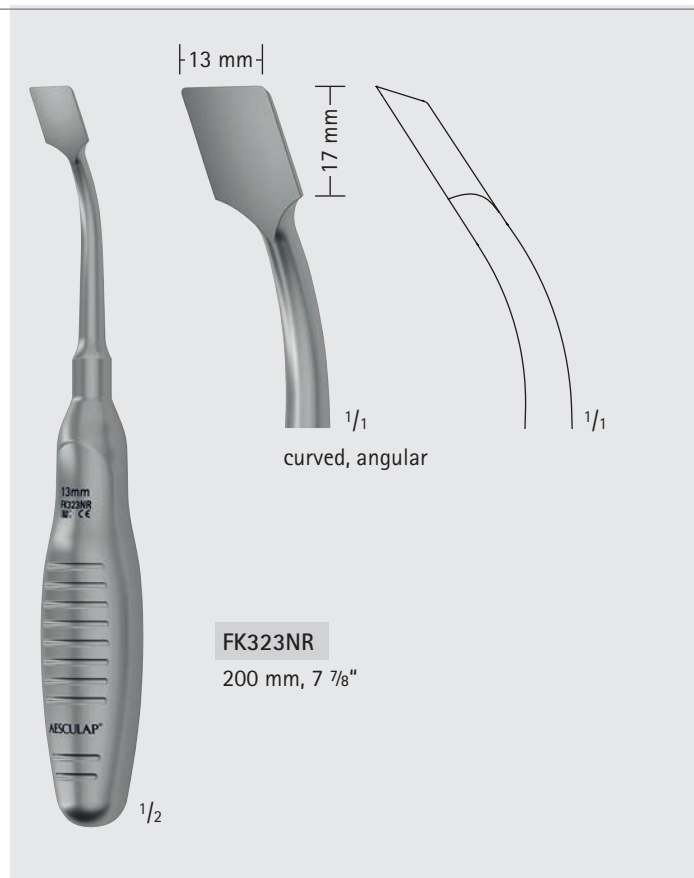
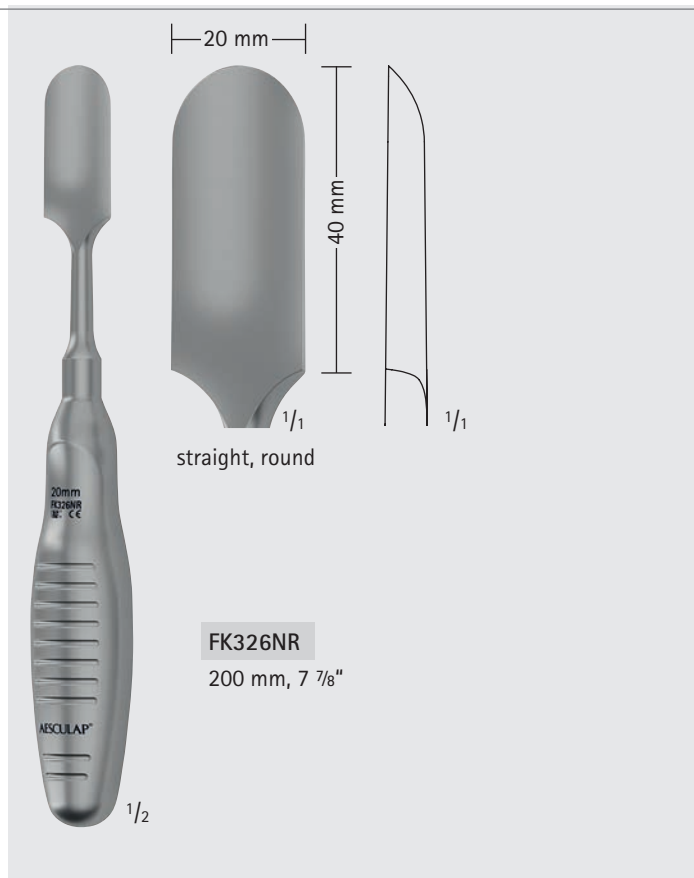

# Aesculap® SQ.line® Surgical Instruments

## Raspatories

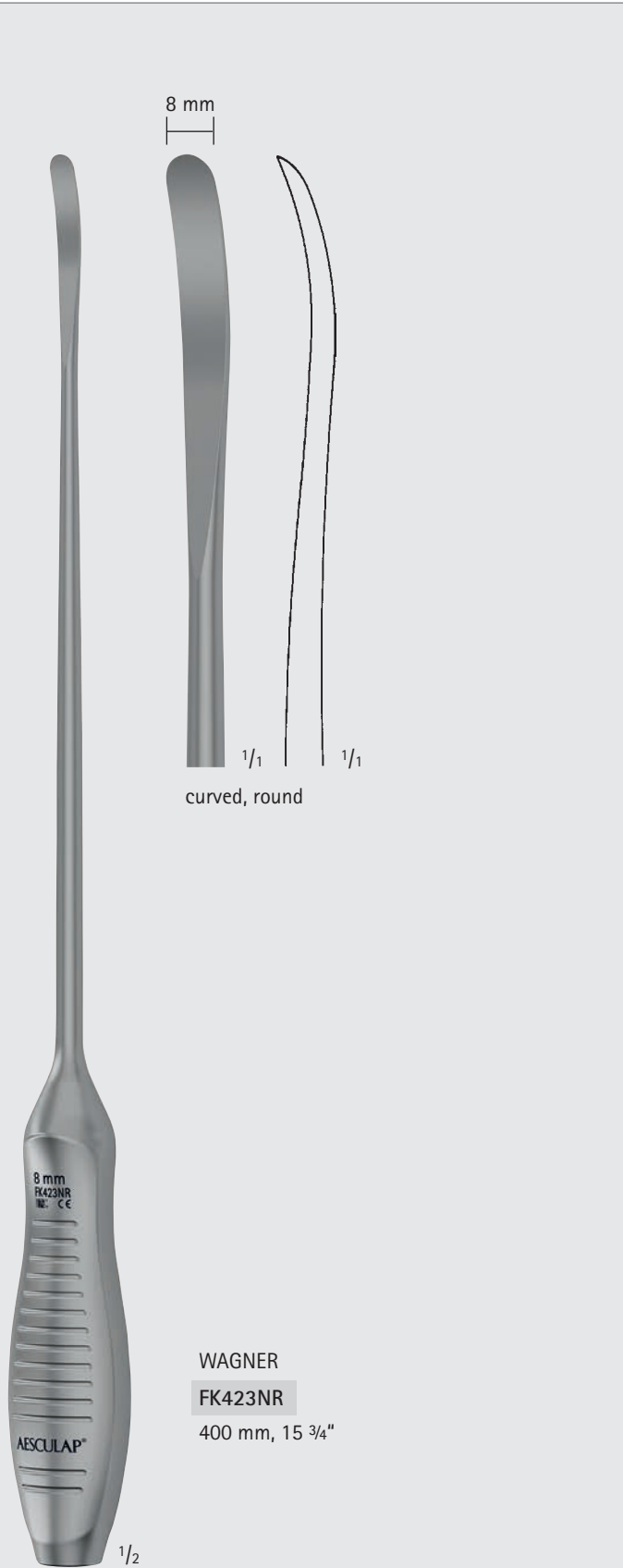
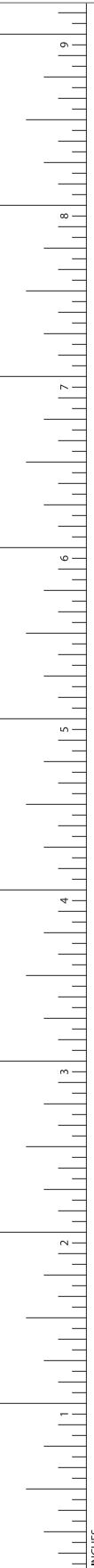

8 mm  
1/1 1/1  
curved, round

WAGNER  
FK423NR  
400 mm, 15 3/4"

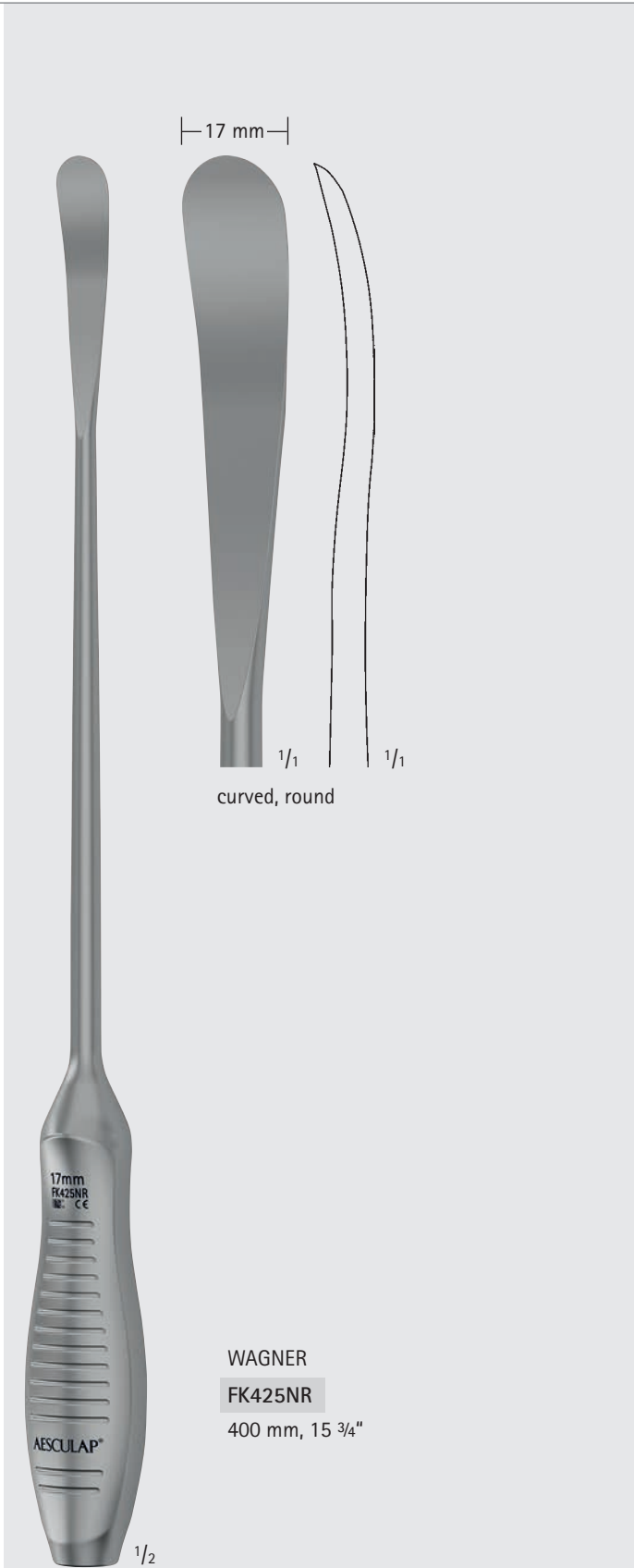

17 mm  
1/1 1/1  
curved, round

WAGNER  
FK425NR  
400 mm, 15 3/4"

# Aesculap® SQ.line® Surgical Instruments

Luxation Lever

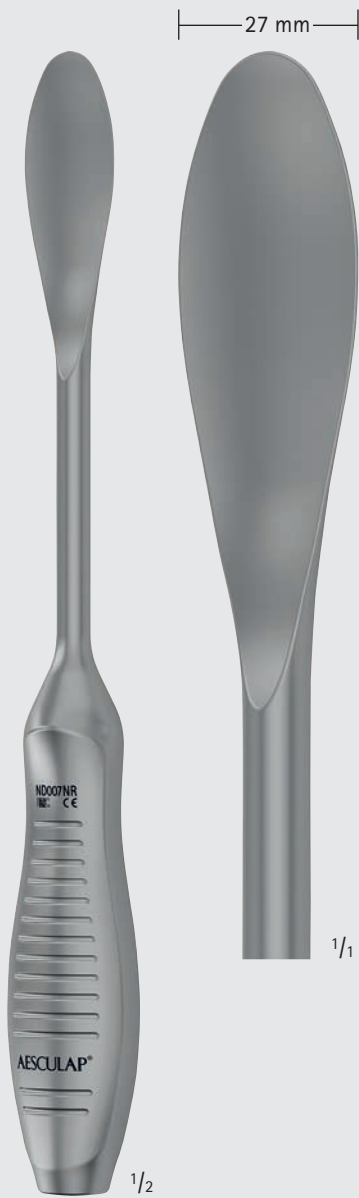

**ND007NR**

for dislocating the  
femoral head  
300 mm, 11 3/4"



MILLIMETERS

# Aesculap® SQ.line® Surgical Instruments

Bone Hook, Drill

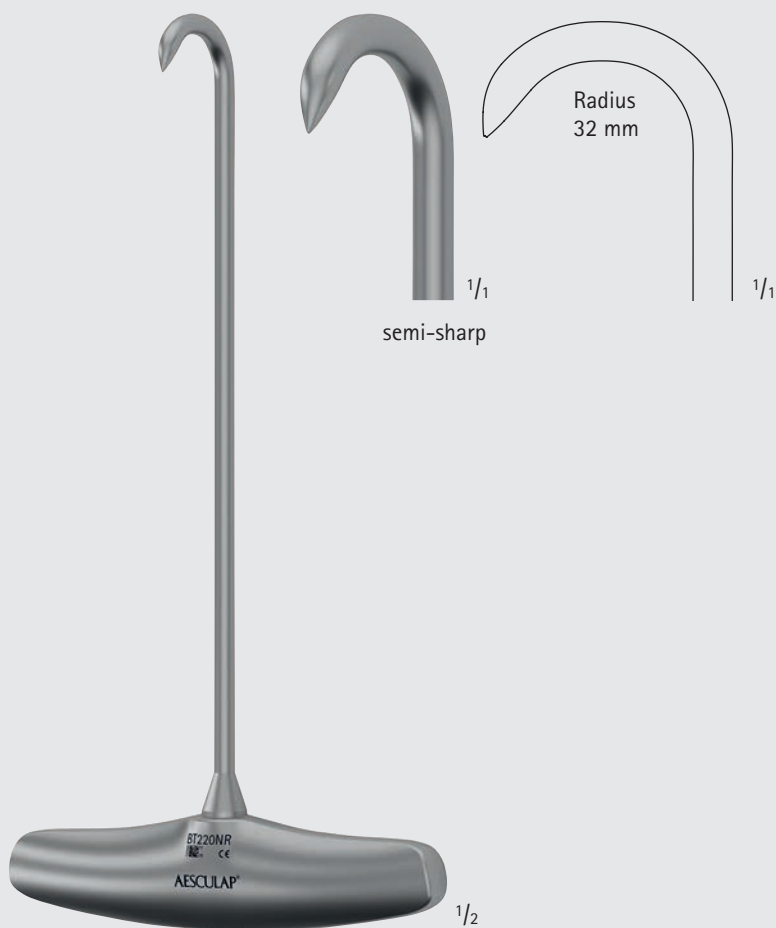
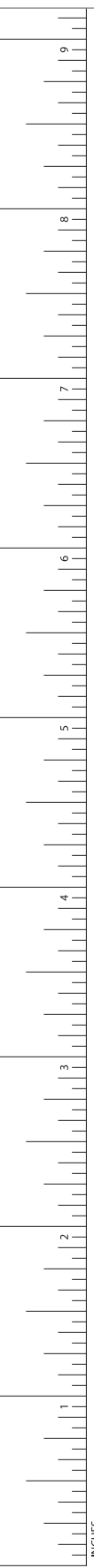

**BT220NR**

Bone hook with T-handle  
240 mm, 9 1/2"

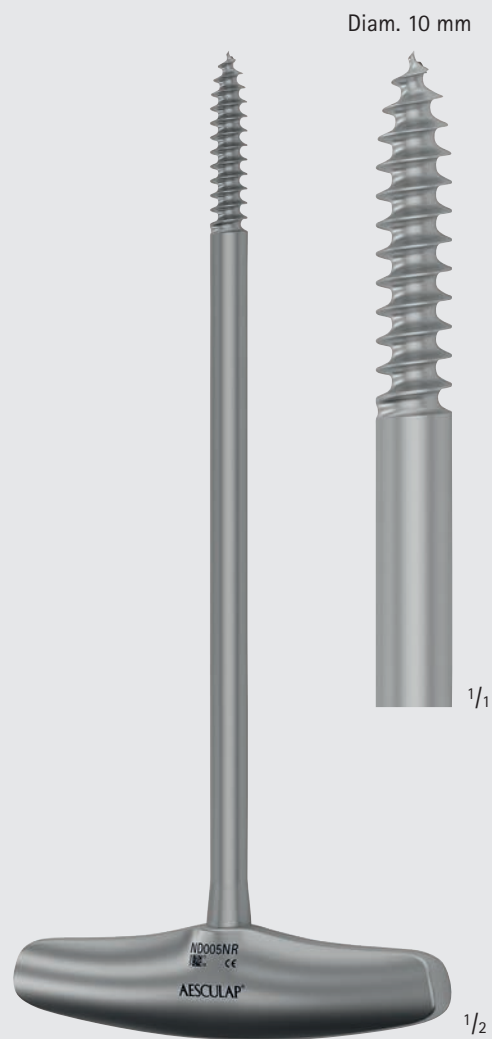

**ND005NR**

Drill with T-handle  
for femoral head extraction  
260 mm, 10 1/4"



# Aesculap® SQ.line® Surgical Instruments

## Ball Spikes



Ball diam. 7 mm  
1/16

**FO102NR**  
200 mm, 7 7/8"



Ball diam. 10 mm  
1/16

**FO103NR**  
240 mm, 9 1/2"

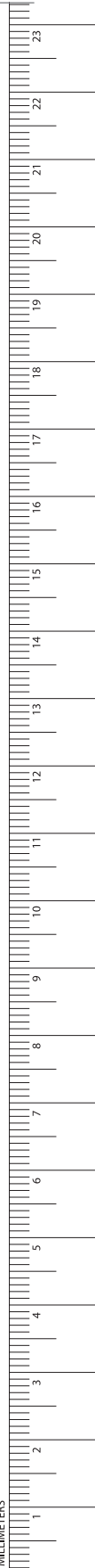

# Aesculap® SQ.line® Surgical Instruments

## Wire Guides

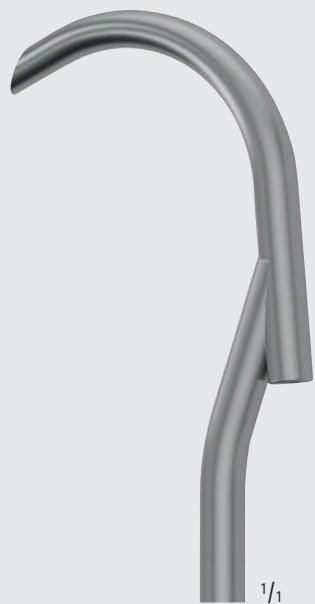
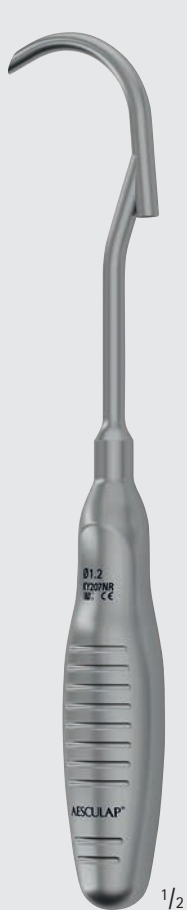
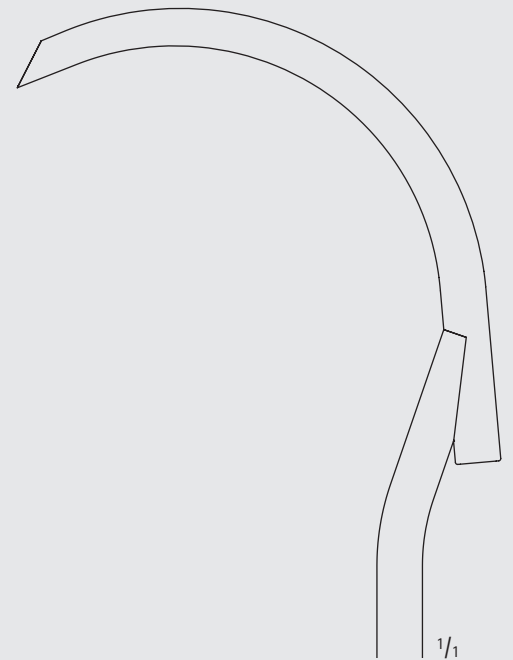
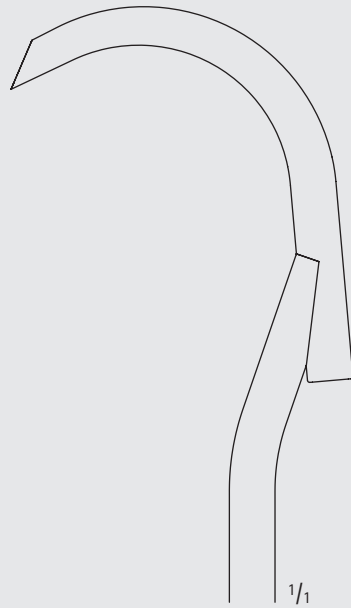
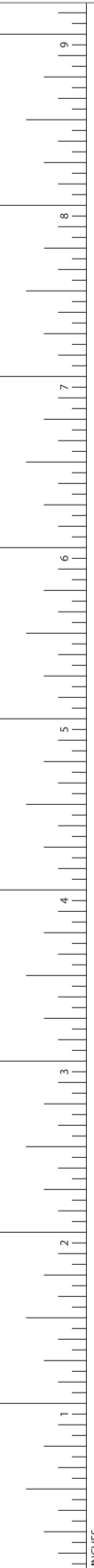

small, curved  
for wire  
diam. 1.2 mm

**KY207NR**  
230 mm, 9"



large, curved  
for wire  
diam. 1.5 mm

**KY208NR**  
240 mm, 9 1/2"

# Aesculap® SQ.line® Surgical Instruments

## Extraction Pliers for Wires



**LX181NR**  
Round pliers  
180 mm, 7"

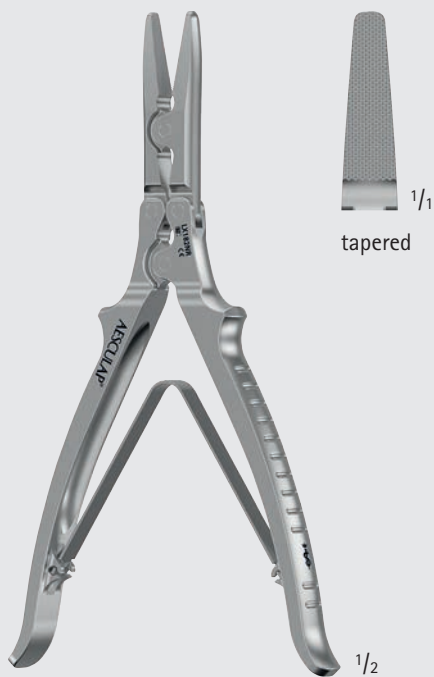

**LX182NR**  
Extraction pliers  
180 mm, 7"

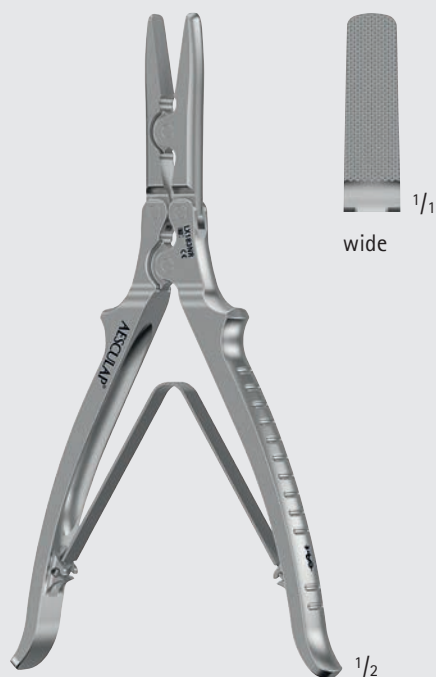

**LX183NR**  
Extraction pliers  
180 mm, 7"

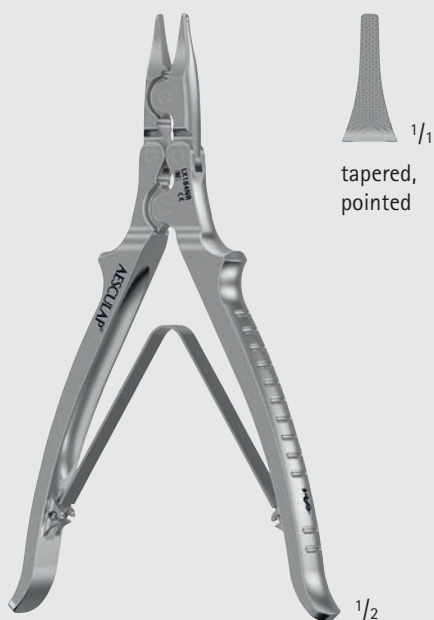

**LX184NR**  
Extraction pliers  
160 mm, 6 1/4"



MILLIMETERS

# Aesculap® SQ.line® Surgical Instruments

Wire Cutters with Carbide Cutting Edges

- specially hardened cutting edges



**LX159NR**

for hard wire with diam. maximum up to 1.5 mm  
180 mm, 7"

- specially hardened cutting edges



**LX157NR**

for hard wire with diam. maximum up to 2.0 mm  
240 mm, 9 1/2"

# Aesculap® SQ.line® Surgical Instruments

## Tampers

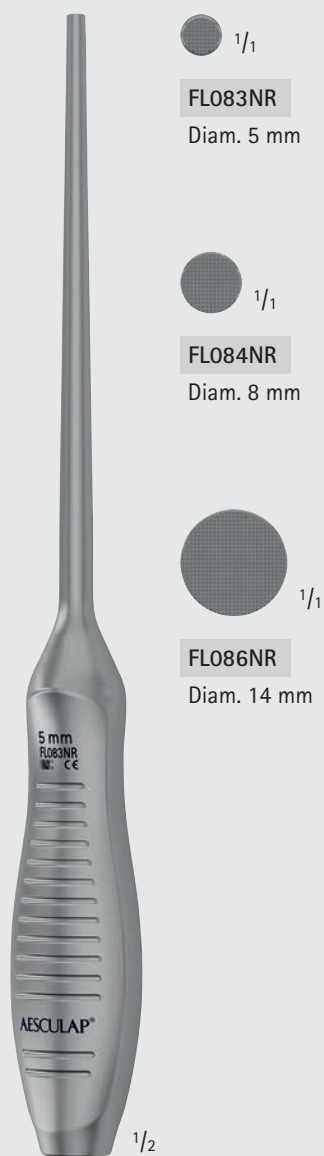

1/1

**FLO83NR**

Diam. 5 mm



1/1

**FLO84NR**

Diam. 8 mm



1/1

**FLO86NR**

Diam. 14 mm

**FLO83NR-FLO86NR**

round, cross serrated  
300 mm, 11 3/4"

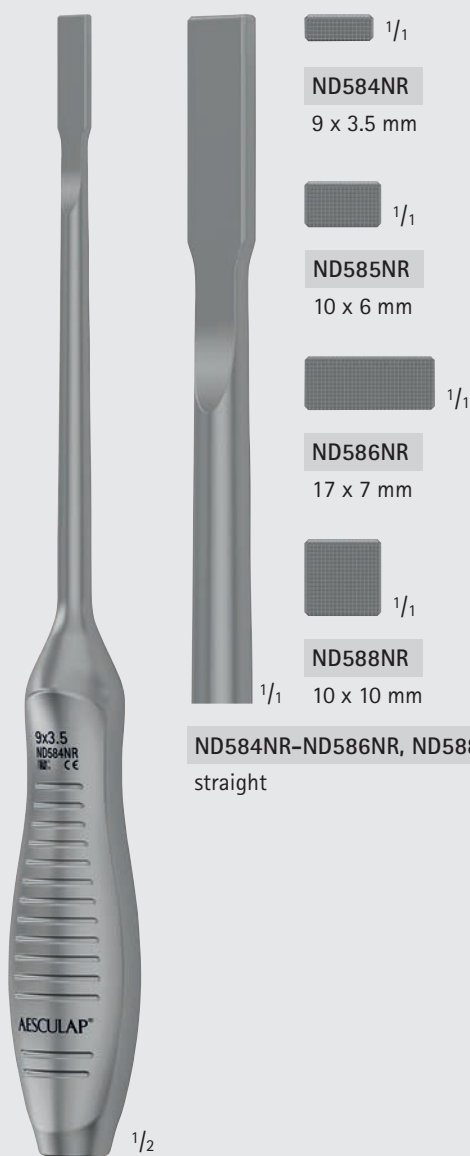

1/1

**ND584NR**

9 x 3.5 mm



1/1

**ND585NR**

10 x 6 mm



1/1

**ND586NR**

17 x 7 mm

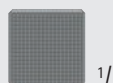

1/1

**ND588NR**

10 x 10 mm

**ND584NR-ND586NR, ND588NR**

straight



1/1

**ND587NR**

10 x 6 mm

**ND587NR**

curved



MILLIMETERS

# Aesculap® SQ.line® Surgical Instruments

## Retractor, Retractor Blades

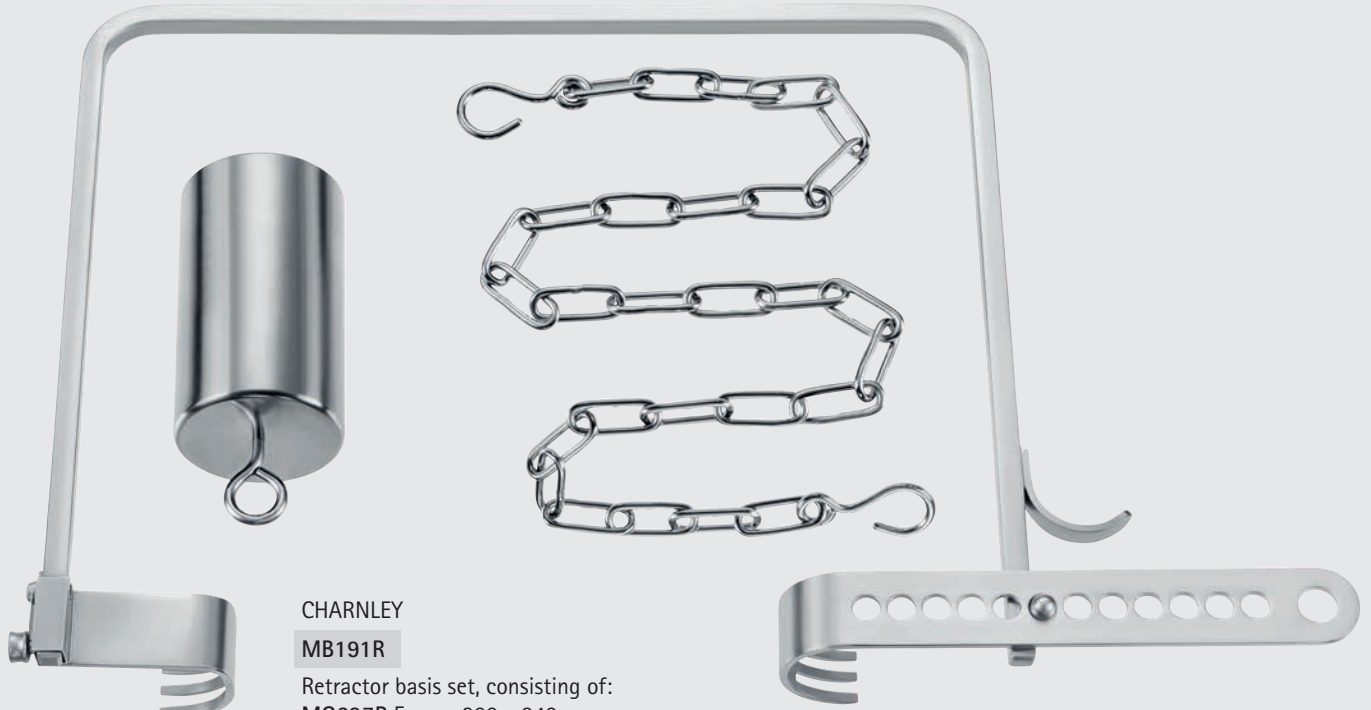

**CHARNLEY**  
**MB191R**

Retractor basis set, consisting of:  
**MG697R** Frame, 300 x 240 mm  
**MG081R** Weight, 1.740 g, with chain  
**MB156R** Blade, small, 60 mm, 37 x 25 mm  
**MB157R** Blade, large, 174 mm, 42 x 25 mm

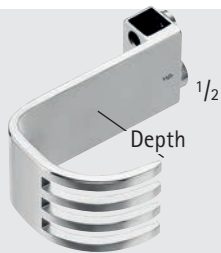

**CHARNLEY**

Art. No.	Depth x Width	Blade length
MG699R	25 x 25 mm	60 mm
MB156R	37 x 25 mm	60 mm
MG698R	51 x 25 mm	60 mm
MG565R	57 x 25 mm	60 mm
MG566R	64 x 25 mm	60 mm
MB177R	76 x 25 mm	60 mm
MG567R	102 x 25 mm	60 mm
MG700R	114 x 25 mm	60 mm
MB192R	127 x 25 mm	60 mm

Retractor blades, small

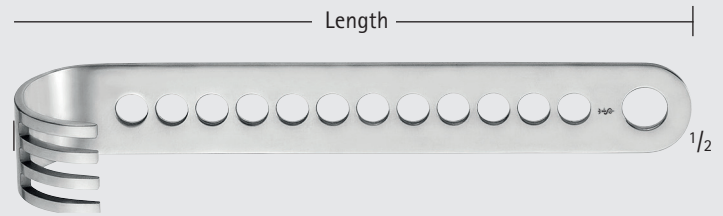

**CHARNLEY**

Art. No.	Depth x Width	Blade length
MG701R	25 x 25 mm	174 mm
MB157R	42 x 25 mm	174 mm
MG702R	51 x 25 mm	198 mm
MG568R	57 x 25 mm	192 mm
MG569R	65 x 25 mm	183 mm
MB178R	76 x 25 mm	174 mm
MG703R	102 x 25 mm	174 mm
MG570R	114 x 25 mm	174 mm
MB193R	127 x 25 mm	174 mm

Retractor blades, large

# Aesculap® SQ.line® Surgical Instruments

## Numerical Index

Art. No.	Page	Art. No.	Page	Art. No.	Page	Art. No.	Page
BT220NR	32	FL066NR	6	FL820NR	9	MB157R	38
FK316NR	28	FL069NR	7	FL821NR	9	MB177R	38
FK317NR	28	FL083NR	37	FL822NR	9	MB178R	38
FK318NR	28	FL084NR	37	FL823NR	9	MB191R	38
FK319NR	28	FL086NR	37	FL825NR	9	MB192R	38
FK321NR	28	FL400NR	9	FL826NR	9	MB193R	38
FK323NR	29	FL401NR	9	FL827NR	9	MB631NR	8
FK324NR	29	FL402NR	9	FL828NR	9	MG081R	38
FK325NR	29	FL403NR	9	FL830NR	11	MG565R	38
FK326NR	29	FL405NR	9	FL831NR	11	MG566R	38
FK423NR	30	FL406NR	9	FL832NR	11	MG566R	38
FK425NR	30	FL407NR	9	FL833NR	11	MG567R	38
FK630NR	25	FL408NR	9	FL835NR	11	MG568R	38
FK631NR	25	FL410NR	11	FL836NR	11	MG569R	38
FK632NR	25	FL411NR	11	FL837NR	11	MG570R	38
FK633NR	25	FL412NR	11	FL838NR	11	MG697R	38
FK634NR	25	FL413NR	11	FL920NR	17	MG698R	38
FK635NR	25	FL415NR	11	FL922NR	17	MG699R	38
FK636NR	25	FL416NR	11	FL925NR	17	MG700R	38
FK637NR	25	FL417NR	11	FL927NR	17	MG701R	38
FK638NR	25	FL418NR	11	FL930NR	12	MG702R	38
FK639NR	25	FL441NR	12	FL932NR	12	MG703R	38
FK640NR	25	FL443NR	12	FL935NR	12	ND005NR	32
FK641NR	25	FL445NR	12	FL937NR	12	ND007NR	31
FK642NR	25	FL650R	19	FO102NR	33	ND019NR	27
FK643NR	25	FL651R	19	FO103NR	33	ND066NR	17
FK644NR	25	FL652R	19	FO515NR	20	ND067NR	17
FK645NR	25	FL653R	19	FO516NR	21	ND068NR	16
FK646NR	25	FL654R	19	FO517NR	21	ND078R	16
FK647NR	25	FL655R	19	FO518NR	20	ND079R	18
FK648NR	25	FL656R	19	FO520NR	20	ND080R	18
FK649NR	25	FL658R	19	FO521NR	21	ND081R	18
FK696NR	27	FL659R	19	FO530NR	22	ND082R	18
FK698NR	27	FL660R	19	FO532NR	22	ND083R	18
FK743NR	26	FL662R	19	FO534NR	22	ND084R	18
FK745NR	26	FL663R	19	FO550NR	23	ND089R	18
FK747NR	26	FL781R	19	FO551NR	23	ND091NR	15
FK753NR	26	FL782R	19	FO641NR	24	ND092NR	15
FK755NR	26	FL783R	19	FO645NR	24	ND093NR	15
FK757NR	26	FL785R	19	KH113NR	8	ND096NR	15
FL046NR	6	FL788R	19	KY207NR	34	ND097NR	15
FL046211	6	FL789R	23	KY208NR	34	ND098NR	15
FL046212	6	FL790R	19	LX157NR	36	ND104NR	13
FL046213	6	FL793R	19	LX159NR	36	ND105NR	13
FL046214	6	FL800R	19	LX181NR	35	ND108NR	10
FL057NR	6	FL801R	19	LX182NR	35	ND109NR	10
FL062NR	7	FL802R	19	LX183NR	35	ND118NR	14
FL062206	7	FL804R	19	LX184NR	35	ND376NR	14
FL062211	7	FL806R	19	MB156R	38	ND584NR	37
FL062212	7	FL808R	19	ND585NR	37	ND586NR	37
FL062213	7	FL809R	19	ND587NR	37	ND588NR	37
FL062214	7	FL810R	19				
		FL812R	19				
		FL813R	19				

All rights reserved. Technical alterations are possible. This leaflet may be used for no other purposes than offering, buying and selling of our products. No part may be copied or reproduced in any form. In the case of misuse we retain the rights to recall our catalogs and price lists and to take legal actions.

©2020 AESCULAP. ALL RIGHTS RESERVED. PRINTED IN THE USA.  
Aesculap is an equal opportunity employer

Aesculap, Inc. | 3773 Corporate Parkway | Center Valley, PA | 18034  
Phone 800-282-9000 | Fax 610-791-6886 | [www.aesculapusa.com](http://www.aesculapusa.com)

Aesculap, Inc. - a B. Braun company

DOC1675\_REVA 500 05/20